

Exclusively foot & ankle **28**
Paragon[®]



PRODUCT INFORMATION

Paragon 28[®] Catalog

Not all products available for sale in all markets. To determine availability in your marketplace, please contact your local Paragon 28 representative or email info@paragon28.com.

1	GORILLA® R3CON PLATING SYSTEM.....4	6	PHANTOM® TTC/TC NAIL AND ACTIVCORE™63
	Gorilla® Ankle Fracture Plates Gorilla® Ankle Fracture Hook & Posterior Plates Gorilla® Ankle Fracture Pilon Plates Gorilla® Bow and Arrow® Plates Gorilla® Calc Fracture Plates Gorilla® Calcaneal Slide Plates Gorilla® Lapidus Plates Gorilla® Lateral Column Plates Gorilla® Lisfranc Plates Gorilla® Medial Column Arch & Rescue Plates Gorilla® MTP Plates Gorilla® NC Fusion Plates Gorilla® Universal Plates Gorilla® R3CON™ Screws Gorilla® R3CON™ Instruments Gorilla® R3CON™ Tray Int'l Stainless-Steel Gorilla® R3CON™ Plate Screw Caddy		Phantom® ActivCore™ Implants Phantom® TTC/TC Nail Implants Phantom® Instruments
2	BABY GORILLA® PLATING SYSTEM.....32	7	PROMO™.....69
	Baby Gorilla® 5th Metatarsal Plates Baby Gorilla® Oblique L-TY Plates Baby Gorilla® Straight L-T Plates Baby Gorilla® Specialty Plates Baby Gorilla® Talar Neck Fracture Plates Baby Gorilla® Zig-Zag Plates Baby Gorilla® Screws Baby Gorilla® Instruments Baby Gorilla® Tray		PROMO™ Plates PROMO™ Screws PROMO™ Instruments and Tray
3	SILVERBACK™ ANKLE FUSION PLATING SYSTEM43	8	HAMMERTUBE™ IMPLANT SYSTEM.....76
	Silverback™ Ankle Fusion Anterior TT/TTC Plates Silverback™ Ankle Fusion Lateral TT/TTC Plates Silverback™ Ankle Fusion Posterior TT/TTC Plates Silverback™ Ankle Fusion Screws Silverback™ K-Wires & Olive Wires Silverback™ Instruments		HammerTube™ Implants HammerTube™ Instruments HammerTube™ Revision Instruments
4	PHANTOM® SMALL BONE INTRAMEDULLARY NAIL SYSTEM55	9	PRECISION JONES™ FRACTURE SCREW SYSTEM.....79
	Phantom® 3-Hole Nails Phantom® 4-Hole Nails Phantom® Instrument		Precision Jones™ Fracture Screws (Cannulated) Precision Jones™ Fracture Screws (Solid) Precision Jones™ Fracture Instruments
5	LAPIDUS CUT GUIDE AND MINIMALLY INVASIVE SYSTEMS.....60	10	JOUST BEAMING SCREW™ SYSTEM85
	Lapidus Cut Guide Lapidus Minimally Invasive Guides Phantom® MIS Lapidus Guides		5.0/5.5 Joust™ Beaming Screws 7.2 Joust™ Beaming Screws Joust™ Beaming Instruments
		11	JAWS™ STAPLE SYSTEM95
			JAWS™ Staples JAWS™ Instruments
		12	GRAPPLER® INTERFERENCE SCREW SYSTEM.....97
			Grappler® Interference Screws Grappler® Interference Screw Instrumentation
		13	R3LEASE™ STABILIZATION SYSTEM.....100
			R3LEASE™ Stabilization Screws/Instruments R3LEASE™ Stabilization Removal Instrumentation
		14	TENOTAC® SOFT TISSUE FIXATION SYSTEM103
			Teno Tac® Implants Kits (Sterile) Teno Tac® Implants/Instruments (Non-Sterile)

**TIP:**

This is a digital reference guide designed to be accessed quickly. Clicking on the sections in the Table of Contents will take you directly to the section selected. Throughout the document, click the P28 logo in the top right corner of the pages to get back to the Table of Contents.

Not all products available for sale in all markets. To determine availability in your marketplace, please contact your local Paragon 28 representative or email info@paragon28.com.

15	APEX 3D™ TOTAL ANKLE REPLACEMENT SYSTEM..... 106	APEX 3D™ Alignment Instrumentation APEX 3D™ Impaction Instrumentation APEX 3D™ Resection Instrumentation APEX 3D™ Implants	22	MINI-MONSTER® SCREW SYSTEM.....137	2.0 Mini-Monster® Screws/Instruments 2.5 Mini-Monster® Screws/Instruments 3.0 Mini-Monster® Screws/Instruments 3.5 Mini-Monster® Screws/Instruments 4.0 Mini-Monster® Screws/Instruments Mini-Monster® Two Pack Tray Mini-Monster® Five Pack Tray 2.0 Mini-Monster® Screws/Instruments (Stainless Steel Caddy) 2.5 Mini-Monster® Screws/Instruments (Stainless Steel Caddy) 3.0 Mini-Monster® Screws/Instruments (Stainless Steel Caddy) 3.5 Mini-Monster® Screws/Instruments (Stainless Steel Caddy) 4.0 Mini-Monster® Screws/Instruments (Stainless Steel Caddy) International 2.0 Mini-Monster® Screws/Instruments International 2.5 Mini-Monster® Screws/Instruments
16	PRESERVE™ BONE WEDGE SYSTEM118	PRESERVE™ AVITRAC® MTP Revision Implants/Instruments PRESERVE™ Evans and Cotton Implants and Trials PRESERVE™ HammerGraft™ Spacers PRESERVE™ Lapidus Implants and Trials PRESERVE™ MTP Implants and Trials PRESERVE™ Universal and Iliac Wedges PRESERVE™ Subtalar and Calc-Cuboid Implants and Trials	23	MINI-MONSTER® SOLID SCREW SYSTEM..... 171	Mini-Monster® Screws and Instrumentation
17	TITAN 3-D™125	Titan 3-D™ Evans and Cotton Implants Titan 3-D™ Instrumentation	24	MONSTER® HINDFOOT SCREW SYSTEM176	4.5 Monster® Hindfoot Screws 5.5 Monster® Hindfoot Screws 7.0 Monster® Hindfoot Screws Monster® Hindfoot Instrumentation, Case, and Tray 4.5 & 5.5 Monster® Hindfoot Instrumentation 4.5 & 7.0 Monster® Hindfoot Instrumentation 5.5 & 7.0 Monster® Hindfoot Instrumentation 4.5 Monster® Hindfoot Screws (Stainless Steel Caddy) 5.5 Monster® Hindfoot Screws (Stainless Steel Caddy) 7.0 Monster® Hindfoot Screws (Stainless Steel Caddy) Monster Stainless Steel Instruments
18	BIOLOGICS.....128	BEAST100® ParaDerm® PRO3™ Amnion Cord Placenta Flowable V92™	25	STERILE PACKAGED PRODUCT.....208	
19	BONE GRAFT HARVESTING SYSTEM.....131	Bone Graft Harvesters/Instruments			
20	MONSTER® BITE SCREW SYSTEM133	Monster® BITE Screws/Instruments			
21	MONSTER® FOREFOOT SYSTEM.....135	Monster® BITE Screws/Instruments			



TIP:

This is a digital reference guide designed to be accessed quickly. Clicking on the sections in the Table of Contents will take you directly to the section selected. Throughout the document, click the P28 logo in the top right corner of the pages to get back to the Table of Contents.

Section 1:

GORILLA® R3CON PLATING SYSTEM

Not all products available for sale in all markets. To determine availability in your marketplace, please contact your local Paragon 28 representative or email info@paragon28.com.



Straight
Tubular Plate



Anatomical
Fibular Plate



Medial
Malleolus Plate

GORILLA® ANKLE FRACTURE PLATES

PART NUMBER	DESCRIPTION
P50-900-UNVC-3	Universal Plate System Lid
P50-900-AFXC-1	Ankle Fracture Caddy Base, Gorilla
P50-353-3510	Gorilla Locking Plate Screw, 3.5 X 10 mm
P50-353-3512	Gorilla Locking Plate Screw, 3.5 X 12 mm
P50-353-3514	Gorilla Locking Plate Screw, 3.5 X 14 mm
P50-353-3516	Gorilla Locking Plate Screw, 3.5 X 16 mm
P50-453-3510	Gorilla Non-Locking Plate Screw, 3.5 X 10 mm
P50-453-3512	Gorilla Non-Locking Plate Screw, 3.5 X 12 mm
P50-453-3514	Gorilla Non-Locking Plate Screw, 3.5 X 14 mm
P50-453-3516	Gorilla Non-Locking Plate Screw, 3.5 X 16 mm
P99-250-1608	Gorilla, Ankle Fx, Half Olive Wire, Smooth
P51-906-1001	Gorilla, Wire Guide, Ankle Fracture, Double Ended, Ø1.2, SS
P51-900-2001	Gorilla, Ankle Fx, Threaded Tower
P53-201-0003	Fibular Plate, Straight, 3 Hole
P53-201-0004	Fibular Plate, Straight, 4 Hole
P53-201-0005	Fibular Plate, Straight, 5 Hole
P53-201-0006	Fibular Plate, Straight, 6 Hole
P53-201-0007	Fibular Plate, Straight, 7 Hole
P53-201-0008	Fibular Plate, Straight, 8 Hole
P53-201-0009	Fibular Plate, Straight, 9 Hole
P53-201-0010	Fibular Plate, Straight, 10 Hole
P53-201-0012	Fibular Plate, Straight, 12 Hole
P53-201-0014	Fibular Plate, Straight, 14 Hole
P53-201-0016	Fibular Plate, Straight, 16 Hole
P53-203-L007	Fibular Plate, Cluster, 7 Hole, Anatomical, Left
P53-203-L009	Fibular Plate, Cluster, 9 Hole, Anatomical, Left
P53-203-L011	Fibular Plate, Cluster, 11 Hole, Anatomical, Left
P53-203-L013	Gorilla, Ankle Fx, Anatomical Fibular Plate, Left, 13-hole
P53-203-L015	Fibular Plate, Cluster, 15 Hole, Anatomical, Left

Not all products available for sale in all markets. To determine availability in your marketplace, please contact your local Paragon 28 representative or email info@paragon28.com.

GORILLA® ANKLE FRACTURE PLATES

PART NUMBER	DESCRIPTION
P53-203-L017	Fibular Plate, Cluster, 17 Hole, Anatomical, Left
P53-203-R007	Fibular Plate, Cluster, 7 Hole, Anatomical, Right
P53-203-R009	Fibular Plate, Cluster, 9 Hole, Anatomical, Right
P53-203-R011	Fibular Plate, Cluster, 11 Hole, Anatomical, Right
P53-203-R013	Fibular Plate, Cluster, 13 Hole, Anatomical, Right
P53-203-R015	Fibular Plate, Cluster, 15 Hole, Anatomical, Right
P53-203-R017	Fibular Plate, Cluster, 17 Hole, Anatomical, Right
P53-210-0007	Medial Malleolus, 7 Hole, Anatomic



Not all products available for sale in all markets. To determine availability in your marketplace, please contact your local Paragon 28 representative or email info@paragon28.com.



Trimalleolar
Fracture Plate



Posterolateral
Tibia Plate



Posterior
Lateral Fibula
Plate



Posteromedial
Tibia Plate



Lateral
Malleolus Hook
Plate



Medial Hook
Plate

GORILLA® ANKLE FRACTURE HOOK & POSTERIOR PLATES

PART NUMBER	DESCRIPTION
P50-900-AFHK-1	Gorilla, Ankle Fracture, Posterior & Hook Plate Caddy
P50-900-UNVC-3	Gorilla, Universal Lid, 9 X 9
P53-204-0005	Gorilla, Ankle Fx, Fibula, Hook Plate, Straight, 05-Hole, TiA
P53-204-0006	Gorilla, Ankle Fx, Fibula, Hook Plate, Straight, 06-Hole, TiA
P53-205-L005	Gorilla, Ankle Fx, Lateral Maleolus, Hook Plate, Anatomical, Left, 05-Hole, TiA
P53-205-L006	Gorilla, Ankle Fx, Lateral Maleolus, Hook Plate, Anatomical, Left, 06-Hole, TiA
P53-205-R005	Gorilla, Ankle Fx, Lateral Maleolus, Hook Plate, Anatomical, Right, 05-Hole, TiA
P53-205-R006	Gorilla, Ankle Fx, Lateral Maleolus, Hook Plate, Anatomical, Right, 06-Hole, TiA
P53-206-0002	Gorilla, Ankle Fx, Medial Malleolus, Hook Plate, 02-Hole, TiA
P53-206-0004	Gorilla, Ankle Fx, Medial Malleolus Plate, Hook, 04-Hole, TiA
P53-208-0007	Gorilla, Ankle Fx, Posterolateral, Fibula Plate, 07-Hole, Alpha, TiA
P53-208-0009	Gorilla, Ankle Fx, Posterolateral, Fibula Plate, 09-Hole, w/Comp, Alpha, TiA
P53-208-0011	Gorilla, Ankle Fx, Posterolateral, Fibula Plate, 11-Hole, w/Comp, Alpha, TiA
P53-208-1007	Gorilla, Ankle Fx, Posterolateral, Fibula Plate, 07-Hole, Beta, TiA
P53-208-1009	Gorilla, Ankle Fx, Posterolateral, Fibula Plate, 09-Hole, w/Comp, Beta, TiA
P53-208-1011	Gorilla, Ankle Fx, Posterolateral, Fibula Plate, 11-Hole, w/Comp, Beta, TiA
P53-207-L005	Gorilla, Ankle Fx, Posterolateral, Tibia Plate, 05-Hole, Left, TiA
P53-207-L006	Gorilla, Ankle Fx, Posterolateral, Tibia Plate, 06-Hole, Left, TiA
P53-207-L007	Gorilla, Ankle Fx, Posterolateral, Tibia Plate, 07-Hole, Left, TiA
P53-207-L008	Gorilla, Ankle Fx, Posterolateral, Tibia Plate, 08-Hole, Left, TiA
P53-207-R005	Gorilla, Ankle Fx, Posterolateral, Tibia Plate, 05-Hole, Right, TiA
P53-207-R006	Gorilla, Ankle Fx, Posterolateral, Tibia Plate, 06-Hole, Right, TiA
P53-207-R007	Gorilla, Ankle Fx, Posterolateral, Tibia Plate, 07-Hole, Right, TiA
P53-207-R008	Gorilla, Ankle Fx, Posterolateral, Tibia Plate, 08-Hole, Right, TiA
P53-209-L006	Gorilla, Ankle Fx, Posteromedial, Tibia Plate, 06-Hole, Left, TiA
P53-209-L008	Gorilla, Ankle Fx, Posteromedial, Tibia Plate, 08-Hole, Left, TiA
P53-209-R006	Gorilla, Ankle Fx, Posteromedial, Tibia Plate, 06-Hole, Right, TiA
P53-209-R008	Gorilla, Ankle Fx, Posteromedial, Tibia Plate, 08-Hole, Right, TiA
P53-211-0003	Gorilla, Ankle Fx, Trimalleolar Fracture Plate, 03-Hole, TiA
P53-211-0004	Gorilla, Ankle Fx, Trimalleolar Fracture Plate, 04-Hole, TiA

Not all products available for sale in all markets. To determine availability in your marketplace, please contact your local Paragon 28 representative or email info@paragon28.com.

GORILLA® ANKLE FRACTURE HOOK & POSTERIOR PLATES

PART NUMBER	DESCRIPTION
P51-900-2001	Ankle Fracture, Locking Tower
P51-922-1001	Ankle Fracture, Tamp, Single Hook
P51-922-1002	Ankle Fracture, Tamp, Double Hook
P51-922-1003	Ankle Fracture, Drill Guide, Double Hook
P99-150-0007	Bone Hook
P99-250-1608	ø1.60mm X 8cm Olive Wire, 316 LVM
P99-250-1610	ø1.60mm X 10cm Olive Wire, 316 LVM



Not all products available for sale in all markets. To determine availability in your marketplace, please contact your local Paragon 28 representative or email info@paragon28.com.



Anterior Distal
Tibia Plate



Anterolateral
Distal Tibia Plate



Medial Distal
Tibia Plate

GORILLA® ANKLE FRACTURE PILON PLATES

PART NUMBER	DESCRIPTION
P50-900-AFPL-1	Gorilla, Ankle Fx., Pilon Plate, Caddy
P50-900-UNVC-3	Gorilla, Universal 9x9 Caddy Lid
P53-212-0002	Gorilla, Ankle Fx., Anterior Distal Tibia Plate, 11 Hole, TiA
P53-212-0004	Gorilla, Ankle Fx., Anterior Distal Tibia Plate, 13 Hole, TiA
P53-212-0006	Gorilla, Ankle Fx., Anterior Distal Tibi Plate, 15 Hole, TiA
P53-213-R004	Gorilla, Ankle Fx., Anterolateral Distal Tibia Plate, Right, 11-Holes, TiA
P53-213-R006	Gorilla, Ankle Fx., Anterolateral Distal Tibia Plate, Right, 13-Holes, TiA
P53-213-R008	Gorilla, Ankle Fx., Anterolateral Distal Tibia Plate, Right, 15-Holes, TiA
P53-213-R010	Gorilla, Ankle Fx., Anterolateral Distal Tibia Plate, Right, 17-Holes, TiA
P53-213-R012	Gorilla, Ankle Fx., Anterolateral Distal Tibia Plate, Right, 19-Holes, TiA
P53-213-R014	Gorilla, Ankle Fx., Anterolateral Distal Tibia Plate, Right, 21-Holes, TiA
P53-213-R016	Gorilla, Ankle Fx., Anterolateral Distal Tibia Plate, Right, 23-Holes, TiA
P53-213-R018	Gorilla, Ankle Fx., Anterolateral Distal Tibia Plate, Right, 23-Holes, TiA
P53-213-L004	Gorilla, Ankle Fx., Anterolateral Distal Tibia Plate, Left, 11-Holes, TiA
P53-213-L006	Gorilla, Ankle Fx., Anterolateral Distal Tibia Plate, Left, 13-Holes, TiA
P53-213-L008	Gorilla, Ankle Fx., Anterolateral Distal Tibia Plate, Left, 15-Holes, TiA
P53-213-L010	Gorilla, Ankle Fx., Anterolateral Distal Tibia Plate, Left, 17-Holes, TiA
P53-213-L012	Gorilla, Ankle Fx., Anterolateral Distal Tibia Plate, Left, 19-Holes, TiA
P53-213-L014	Gorilla, Ankle Fx., Anterolateral Distal Tibia Plate, Left, 21-Holes, TiA
P53-213-L016	Gorilla, Ankle Fx., Anterolateral Distal Tibia Plate, Left, 23-Holes, TiA
P53-213-L018	Gorilla, Ankle Fx., Anterolateral Distal Tibia Plate, Left, 25-Holes, TiA
P53-214-1004	Gorilla, Ankle Fx., Medial Distal Tibia Plate, 11-Holes, TiA
P53-214-1006	Gorilla, Ankle Fx., Medial Distal Tibia Plate, 13-Holes, TiA
P53-214-1008	Gorilla, Ankle Fx., Medial Distal Tibia Plate, 15-Holes, TiA
P53-214-1010	Gorilla, Ankle Fx., Medial Distal Tibia Plate, 17-Holes, TiA
P53-214-1012	Gorilla, Ankle Fx., Medial Distal Tibia Plate, 19-Holes, TiA
P53-214-1014	Gorilla, Ankle Fx., Medial Distal Tibia Plate, 21-Holes, TiA
P53-214-1016	Gorilla, Ankle Fx., Medial Distal Tibia Plate, 23-Holes, TiA

Not all products available for sale in all markets. To determine availability in your marketplace, please contact your local Paragon 28 representative or email info@paragon28.com.



Evans Plate



Cotton Plate



Base Opening
Wedge (BOW)
Plate

GORILLA® BOW AND ARROW® PLATES

PART NUMBER	DESCRIPTION
P50-900-BOWC-1	Bow Implant Caddy, Gorilla
P50-900-BOWC-2	Bow Implant caddy Lid, Gorilla
P50-900-0001	Bow & Arrow Sizing Tool, Base & Cotton Small
P51-920-1001	Spreader, TearDrop, Bow & Arrow
P51-920-1002	Bow & Arrow Sizing Tool, Evans Large
P51-920-1003	Bow Osteotome, 6mm, Dual Taper
P51-920-1004	Bow Osteotome, 12mm, Single Taper
P53-104-0000	Bow & Arrow, Base Wedge Plate, 0.0mm Wedge
P53-104-0020	Bow & Arrow, Base Wedge Plate, 2.0mm Wedge
P53-104-0025	Bow & Arrow, Base Wedge Plate, 2.5mm Wedge
P53-104-0030	Bow & Arrow, Base Wedge Plate, 3.0mm Wedge
P53-104-0035	Bow & Arrow, Base Wedge Plate, 3.5mm Wedge
P53-104-0040	Bow & Arrow, Base Wedge Plate, 4.0mm Wedge
P53-104-0045	Bow & Arrow, Base Wedge Plate, 4.5mm Wedge
P53-104-0150	Bow & Arrow Cotton Plate, 5mm Wedge
P53-104-0160	Bow & Arrow Cotton Plate, 6mm Wedge
P53-104-0170	Bow & Arrow Cotton Plate, 7mm Wedge
P53-104-0180	Bow & Arrow Cotton Plate, 8mm Wedge
P53-104-0206	Bow & Arrow, Evans Plate, 6mm Wedge
P53-104-0208	Bow & Arrow, Evans Plate, 8mm Wedge
P53-104-0210	Bow & Arrow, Evans Plate, 10mm Wedge
P53-104-0212	Bow & Arrow, Evans Plate, 12mm Wedge

Not all products available for sale in all markets. To determine availability in your marketplace, please contact your local Paragon 28 representative or email info@paragon28.com.

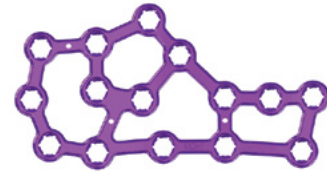

Sinus Tarsi Plate

Sinus Tarsi
Support Plate

Perimeter Plate

GORILLA® CALC FRACTURE PLATES

PART NUMBER	DESCRIPTION
P50-900-CFXC-2	Gorilla, Calcaneal Fracture and ReducTiAon Implant Caddy, Base
P50-900-CFXC-3	Gorilla, Calcaneal Fracture and ReducTiAon Implant Caddy, Implant Tray
P50-900-UNVC-3	Gorilla, Caddy Lid, Large with Strut
P50-353-3528	Gorilla, R3CON™ Plate Screw, Locking, 3.5 x 28 mm, TiA
P50-353-3530	Gorilla, R3CON™ Plate Screw, Locking, 3.5 x 30 mm, TiA
P50-353-3532	Gorilla, R3CON™ Plate Screw, Locking, 3.5 x 32 mm, TiA
P50-353-3534	Gorilla, R3CON™ Plate Screw, Locking, 3.5 x 34 mm, TiA
P53-102-L000	Gorilla, Calcaneal Fracture, Perimeter Plate, Extra Small, Left, TiA
P53-102-L001	Gorilla, Calcaneal Fracture, Perimeter Plate, Small, Left, TiA
P53-102-L002	Gorilla, Calcaneal Fracture, Perimeter Plate, Medium, Left, TiA
P53-102-L003	Gorilla, Calcaneal Fracture, Perimeter Plate, Large, Left, TiA
P53-102-L101	Gorilla, Calcaneal Fracture, Sinus Tarsi+Support Plate, Small, Left, TiA
P53-102-L102	Gorilla, Calcaneal Fracture, Sinus Tarsi+Support Plate, Medium, Left, TiA
P53-102-L103	Gorilla, Calcaneal Fracture, Sinus Tarsi+Support Plate, Large, Left, TiA
P53-102-L201	Gorilla, Calcaneal Fracture, Sinus Tarsi Plate, Small, Left, TiA
P53-102-L202	Gorilla, Calcaneal Fracture, Sinus Tarsi Plate, Medium, Left, TiA
P53-102-L203	Gorilla, Calcaneal Fracture, Sinus Tarsi Plate, Large, Left, TiA
P53-102-R000	Gorilla, Calcaneal Fracture, Perimeter Plate, Extra Small, Right, TiA
P53-102-R001	Gorilla, Calcaneal Fracture, Perimeter Plate, Small, Right, TiA
P53-102-R002	Gorilla, Calcaneal Fracture, Perimeter Plate, Medium, Right, TiA
P53-102-R003	Gorilla, Calcaneal Fracture, Perimeter Plate, Large, Right, TiA
P53-102-R101	Gorilla, Calcaneal Fracture, Sinus Tarsi+Support Plate, Small, Right, TiA
P53-102-R102	Gorilla, Calcaneal Fracture, Sinus Tarsi+Support Plate, Medium, Right, TiA
P53-102-R103	Gorilla, Calcaneal Fracture, Sinus Tarsi+Support Plate, Large, Right, TiA
P53-102-R201	Gorilla, Calcaneal Fracture, Sinus Tarsi Plate, Small, Right, TiA
P53-102-R202	Gorilla, Calcaneal Fracture, Sinus Tarsi Plate, Medium, Right, TiA
P53-102-R203	Gorilla, Calcaneal Fracture, Sinus Tarsi Plate, Large, Right, TiA
P51-920-1006	Gorilla, Calcaneal Fracture, DissecTiAon Tool, SS
P51-920-1007	Gorilla, Calcaneal Fracture, Sinus Tarsi, Support Plate Inserter

Not all products available for sale in all markets. To determine availability in your marketplace, please contact your local Paragon 28 representative or email info@paragon28.com.

GORILLA® CALC FRACTURE PLATES

PART NUMBER	DESCRIPTION
P51-920-1010	Gorilla, Calcaneal Fracture, Sinus Tarsi, Drill Guide, Locking
P51-920-1011	Gorilla, Calcaneal Fracture, Sinus Tarsi, Incision Guide, Small
P51-920-1012	Gorilla, Calcaneal Fracture, Sinus Tarsi, Incision Guide, Medium
P51-920-1013	Gorilla, Calcaneal Fracture, Sinus Tarsi, Incision Guide, Large
P99-000-AOTH	P28, T-Handle, AO Non-ratcheTiAng, Solid, SS
P99-300-4013	P28, Schanz Pin, Ø4.0mm, AO Connect, SS
P99-300-6013	P28, Schanz Pin, Ø6.0mm, AO Connect, SS
P99-192-2320	P28, K-wire, Ø2.3 x 200mm, Smooth, SS
P99-192-2920	P28, K-wire, Ø2.9 x 200mm, Smooth, SS

JUMP TO GORILLA PLATES
STERILE PACKAGED PRODUCT



Calc Slide Plate

GORILLA® CALCANEAL SLIDE PLATES

PART NUMBER	DESCRIPTION
P50-900-CSLC-1	Calc Slide Implant Caddy Base, Gorilla
P50-900-BOWC-2	Bow Implant Caddy Lid, Gorilla
P53-107-2015	Medial Slide, Beaver Plate
P51-907-0002	Calcaneal Slide Plate, Inserter
P51-907-0006	Calcaneal Slide Plate, Swivel Guide
P99-192-2515	K-Wire, Smooth, 2.5 X 150 mm

JUMP TO GORILLA PLATES
STERILE PACKAGED PRODUCT



Not all products available for sale in all markets. To determine availability in your marketplace, please contact your local Paragon 28 representative or email info@paragon28.com.



3 Hole Plate



Primary Plate

Medial Wall
Step-off PlateGraft-Spanning
Plate

Precision® Guide

GORILLA® LAPIDUS PLATES

PART NUMBER	DESCRIPTION
P50-900-LAPC-1	Lapidus Plate System Caddy Base
P50-900-UNVC-3	Universal Plate System Lid, Gorilla
P53-106-L001	Lapidus, 4-Hole Standard, Compression Plate, Left, Precision Guide
P53-106-L002	Lapidus, Graft Span Small, For 5-8mm Grafts, 4-Hole W/ Comp, Left
P53-106-L003	Lapidus, Graft Span Medium, For 10-12mm Grafts, 5-Hole, Left
P53-106-L005	Lapidus, Graft Span Large, For 14mm Grafts, 5-Hole, Left 1
P53-106-L201	Lapidus, 1 mm Step Plate, Left, Precision Guide
P53-106-L202	Lapidus, 2 mm Step Plate, Left, Precision Guide 1
P53-106-L203	Lapidus, 3 mm Step Plate, Left, Precision Guide
P53-106-L204	Lapidus, 4 mm Step Plate, Left
P53-106-L205	Lapidus, 5 mm Step Plate, Left
P53-106-R001	Lapidus, 4-Hole Standard, Compression Plate, Right, Precision Guide
P53-106-R002	Lapidus, Graft Span Small, For 5-8mm Grafts, 4-Hole W/ Comp, Right
P53-106-R003	Lapidus, Graft Span Medium, For 10-12mm Grafts, 5-Hole, Right
P53-106-R005	Lapidus, Graft Span Large, For 14mm Grafts, 5-Hole, Right
P53-106-R201	Lapidus, 1 mm Step Plate, Right, Precision Guide
P53-106-R202	Lapidus, 2 mm Step Plate, Right, Precision Guide
P53-106-R203	Lapidus, 3 mm Step Plate, Right, Precision Guide
P53-106-R204	Lapidus, 4 mm Step Plate, Right
P53-106-R205	Lapidus, 5 mm Step Plate, Right
P51-950-0002	Precision Guide Set Screw
P51-950-0012	Guidewire Sleeve, 1.2 mm
P51-950-0014	Guidewire Sleeve, 1.4 mm
P51-950-L106	Lapidus Precision Guide, Left
P51-950-R106	Lapidus Precision Guide, Right



Not all products available for sale in all markets. To determine availability in your marketplace, please contact your local Paragon 28 representative or email info@paragon28.com.



Lateral Column Standard Plate

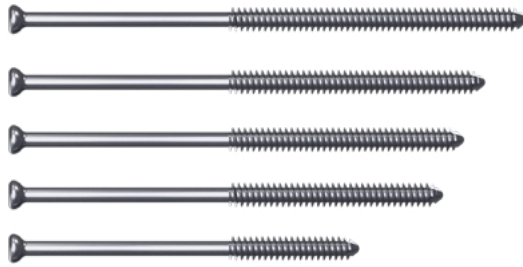

Non-Locking, Partially Threaded Lateral Column Beams

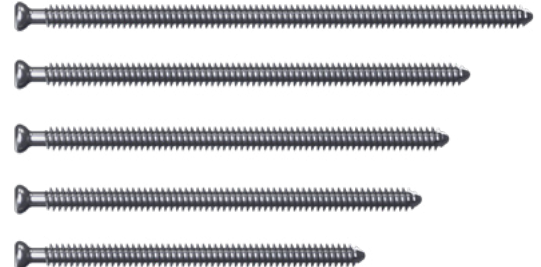

Non-Locking, Fully Threaded Lateral Column Beams

GORILLA® LATERAL COLUMN PLATES

PART NUMBER	DESCRIPTION
P50-900-LCFC-1	Caddy, Lateral Column Fusion, Plates and Instruments
P50-900-UNVC-3	Caddy Lid, Gorilla Universal Plate with Strut
P53-111-L001	Gorilla, Plate, LCF (Lateral Column Fusion), Left, Standard, TiA
P53-111-L002	Gorilla, Plate, LCF (Lateral Column Fusion), Left, Large, TiA
P53-111-R001	Gorilla, Plate, LCF (Lateral Column Fusion), Right, Standard, TiA
P53-111-R002	Gorilla, Plate, LCF (Lateral Column Fusion), Right, Large, TiA
P50-455-080F	LCF, Ø5.5 x 80mm, Non-Locking, Fully Threaded, TiA
P50-455-085F	LCF, Ø5.5 x 85mm, Non-Locking, Fully Threaded, TiA
P50-455-090F	LCF, Ø5.5 x 90mm, Non-Locking, Fully Threaded, TiA
P50-455-095F	LCF, Ø5.5 x 95mm, Non-Locking, Fully Threaded, TiA
P50-455-100F	LCF, Ø5.5 x 100mm, Non-Locking, Fully Threaded, TiA
P50-455-105F	LCF, Ø5.5 x 105mm, Non-Locking, Fully Threaded, TiA
P50-455-110F	LCF, Ø5.5 x 110mm, Non-Locking, Fully Threaded, TiA
P50-455-115F	LCF, Ø5.5 x 115mm, Non-Locking, Fully Threaded, TiA
P50-455-120F	LCF, Ø5.5 x 120mm, Non-Locking, Fully Threaded, TiA
P50-455-080L	LCF, Ø5.5 x 80mm, Non-Locking, Partially Threaded, TiA
P50-455-085L	LCF, Ø5.5 x 85mm, Non-Locking, Partially Threaded, TiA
P50-455-090L	LCF, Ø5.5 x 90mm, Non-Locking, Partially Threaded, TiA
P50-455-095L	LCF, Ø5.5 x 95mm, Non-Locking, Partially Threaded, TiA
P50-455-100L	LCF, Ø5.5 x 100mm, Non-Locking, Partially Threaded, TiA
P50-455-105L	LCF, Ø5.5 x 105mm, Non-Locking, Partially Threaded, TiA
P50-455-110L	LCF, Ø5.5 x 110mm, Non-Locking, Partially Threaded, TiA
P50-455-115L	LCF, Ø5.5 x 115mm, Non-Locking, Partially Threaded, TiA
P50-455-120L	LCF, Ø5.5 x 120mm, Non-Locking, Partially Threaded, TiA
P51-111-L001	Gorilla, LCF, Plate Template Left, Standard, SS
P51-111-L002	Gorilla, LCF, Plate Template Left, Large, SS
P51-111-R001	Gorilla, LCF, Plate Template Right, Standard, SS
P51-111-R002	Gorilla, LCF, Plate Template Right, Large, SS
P51-924-0002	LCF, K-wire Guide, SS

Not all products available for sale in all markets. To determine availability in your marketplace, please contact your local Paragon 28 representative or email info@paragon28.com.

GLCF - GORILLA LATERAL COLUMN FUSION

PART NUMBER	DESCRIPTION
P51-924-0003	LCF, Joint Preparation Paddle, SS
P51-924-0004	LCF, Reamer, SS
P51-924-0005	LCF, Tissue protector, SS
P51-924-0006	LCF, Depth Gauge, SS
P99-110-3517	LCF, Drill, ø3.5mm x 16cm
P99-191-LC25	Driver, Solid, TX 25, AO
P99-192-1620	K-wire, Single Ended Trocar Tip, Smooth, 1.6 x 200 mm
P99-193-1620	K-wire, Single Ended Trocar Tip, Threaded, 1.6 x 200 mm

JUMP TO GORILLA PLATES
STERILE PACKAGED PRODUCT 

JUMP TO GORILLA SCREWS
STERILE PACKAGED PRODUCT 

Not all products available for sale in all markets. To determine availability in your marketplace, please contact your local Paragon 28 representative or email info@paragon28.com.



Dual Ray Plate -
1st and 2nd



Dual Ray Plate -
2nd and 3rd



Slanted T-Plate



Slanted Straight
Plate



Clover Plate

GORILLA® LISFRANC PLATES

PART NUMBER	DESCRIPTION
P50-900-LSFC-1	Caddy, Lisfranc, Full, Gorilla
P50-900-UNVC-3	Universal Plate System Lid, Gorilla
P53-110-L000	Lisfranc, Slanted T, 3 Hole Plate W/ Compression, Left
P53-110-L001	Lisfranc, Slanted T, 4 Hole Plate W/ Compression, Left
P53-110-L002	Lisfranc, Slanted T, 5 Hole Plate W/ Compression, Left
P53-110-L100	Lisfranc, Slanted Straight, 3 Hole Plate, Left, Slant
P53-110-L101	Lisfranc, Slanted Straight, 4 Hole Plate, Left, Slant
P53-110-L102	Lisfranc, Slanted Straight, 5 Hole Plate, Left, Slant
P53-110-L201	Lisfranc, Dual Ray, 1st & 2nd Tmt Plate, Left, Small
P53-110-L202	Lisfranc, Dual Ray, 1st & 2nd Tmt Plate, Left, Medium
P53-110-L203	Lisfranc, Dual Ray, 1st & 2nd Tmt Plate, Left, Large
P53-110-L211	Lisfranc, Dual Ray, 2nd & 3rd Tmt Plate, Left, Small
P53-110-L212	Lisfranc, Dual Ray, 2nd & 3rd Tmt Plate, Left, Medium
P53-110-L213	Lisfranc, Dual Ray, 2nd & 3rd Tmt Plate, Left, Large
P53-110-L301	Lisfranc, 5 Hole Clover Plate, Left, Compression
P53-110-L302	Lisfranc, 6 Hole Clover Plate, Left, Compression
P53-110-R000	Lisfranc, Slanted T, 3 Hole Plate W/ Compression, Right
P53-110-R001	Lisfranc, Slanted T, 4 Hole Plate W/ Compression, Right
P53-110-R002	Lisfranc, Slanted T, 5 Hole Plate W/ Compression, Right
P53-110-R100	Lisfranc, Slanted Straight, 3 Hole Plate, Right, Slant
P53-110-R101	Lisfranc, Slanted Straight, 4 Hole Plate, Right, Slant
P53-110-R102	Lisfranc, Slanted Straight, 5 Hole Plate, Right, Slant
P53-110-R201	Lisfranc, Dual Ray, 1st & 2nd Tmt Plate, Right, Small
P53-110-R202	Lisfranc, Dual Ray, 1st & 2nd Tmt Plate, Right, Medium
P53-110-R203	Lisfranc, Dual Ray, 1st & 2nd Tmt Plate, Right, Large
P53-110-R211	Lisfranc, Dual Ray, 2nd & 3rd Tmt Plate, Right, Small
P53-110-R212	Lisfranc, Dual Ray, 2nd & 3rd Tmt Plate, Right, Medium
P53-110-R213	Lisfranc, Dual Ray, 2nd & 3rd Tmt Plate, Right, Large
P53-110-R301	Lisfranc, 5 Hole Clover Plate, Right, Compression
P53-110-R302	Lisfranc, 6 Hole Clover Plate, Right, Compression

JUMP TO GORILLA PLATES
STERILE PACKAGED PRODUCT



Not all products available for sale in all markets. To determine availability in your marketplace, please contact your local Paragon 28 representative or email info@paragon28.com.

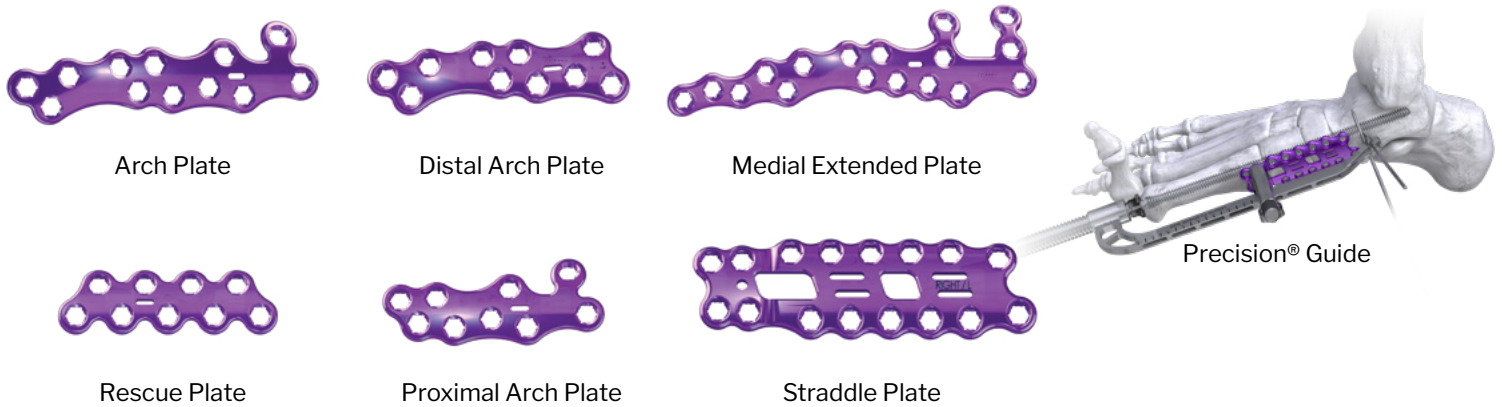

GORILLA® MEDIAL COLUMN ARCH & RESCUE PLATES

PART NUMBER	DESCRIPTION
P50-900-MCAC-1	Medial Column Arch Caddy Base, Gorilla
P50-900-UNVC-3	Universal Plate System Lid, Gorilla
P53-109-1009	Med Col Rescue, 9-hole, 1.5mm
P53-109-1011	Med Col Rescue, 11-hole, 1.5mm
P53-109-1015	Med Col Rescue, 15-hole, 1.5mm
P53-109-1109	Med Col Rescue, 9-hole, 2.0mm
P53-109-1111	Med Col Rescue, 11-hole, 2.0mm
P53-109-1115	Med Col Rescue, 15-hole, 2.0mm
P53-109-L001	Gorilla, Plate, Medial Column Arch, 1.5mm Thk, Left, Small
P53-109-L002	Gorilla, Plate, Medial Column Arch, 1.5mm Thk, Left, Medium
P53-109-L003	Gorilla, Plate, Medial Column Arch, 1.5mm Thk, Left, Large
P53-109-L011	Med Col Proximal Arch, Left, Small, 1.5mm
P53-109-L012	Med Col Proximal Arch, Left, Medium, 1.5mm
P53-109-L013	Med Col Proximal Arch, Left, Large, 1.5mm
P53-109-L101	Gorilla, Plate, Medial Column Arch, 2.0mm Thk, Left, Small
P53-109-L102	Gorilla, Plate, Medial Column Arch, 2.0mm Thk, Left, Medium
P53-109-L103	Gorilla, Plate, Medial Column Arch, 2.0mm Thk, Left, Large
P53-109-L111	Med Col Distal Arch, Left, Small, 2.0mm
P53-109-L112	Med Col Distal Arch, Left, Medium, 2.0mm
P53-109-L113	Med Col Distal Arch, Left, Large, 2.0mm
P53-109-R001	Gorilla, Plate, Medial Column Arch, 1.5mm Thk, Right, Small
P53-109-R002	Gorilla, Plate, Medial Column Arch, 1.5mm Thk, Right, Medium
P53-109-R003	Gorilla, Plate, Medial Column Arch, 1.5mm Thk, Right, Large
P53-109-R011	Med Col Proximal Arch, Right, Small, 1.5mm
P53-109-R012	Med Col Proximal Arch, Right, Medium, 1.5mm
P53-109-R013	Med Col Proximal Arch, Right, Large, 1.5mm
P53-109-R101	Gorilla, Plate, Medial Column Arch, 2.0mm Thk, Right, Small
P53-109-R102	Gorilla, Plate, Medial Column Arch, 2.0mm Thk, Right, Medium
P53-109-R103	Gorilla, Plate, Medial Column Arch, 2.0mm Thk, Right, Large

Not all products available for sale in all markets. To determine availability in your marketplace, please contact your local Paragon 28 representative or email info@paragon28.com.

GORILLA® MEDIAL COLUMN ARCH & RESCUE PLATES

PART NUMBER	DESCRIPTION
P53-109-R111	Med Col Distal Arch, Right, Small, 2.0mm
P53-109-R112	Med Col Distal Arch, Right, Medium, 2.0mm
P53-109-R113	Med Col Distal Arch, Right, Large, 2.0mm
P53-109-L151	Gorilla, Plate, Med Col Ext Arch, 2.0mm Thk, Left, Sm, TiA
P53-109-L152	Gorilla, Plate, Med Col Ext Arch, 2.0mm Thk, Left, Md, TiA
P53-109-L153	Gorilla, Plate, Med Col Ext Arch, 2.0mm Thk, Left, Lg, TiA
P53-109-R151	Gorilla, Plate, Med Col Ext Arch, 2.0mm Thk, Right, Sm, TiA
P53-109-R152	Gorilla, Plate, Med Col Ext Arch, 2.0mm Thk, Right, Md, TiA
P53-109-R153	Gorilla, Plate, Med Col Ext Arch, 2.0mm Thk, Right, Lg, TiA
P53-109-L210	Gorilla Grip™ Plate, 2.0mm Thickness, Left, X-Small
P53-109-L211	Gorilla Grip™ Plate, 2.0mm Thickness, Left, Small
P53-109-L212	Gorilla Grip™ Plate, 2.0mm Thickness, Left, Medium
P53-109-L213	Gorilla Grip™ Plate, 2.0mm Thickness, Left, Large
P53-109-L214	Gorilla Grip™ Plate, 2.0mm Thickness, Left, X-Large
P53-109-R210	Gorilla Grip™ Plate, 2.0mm Thickness, Right, X-Small
P53-109-R211	Gorilla Grip™ Plate, 2.0mm Thickness, Right, Small
P53-109-R212	Gorilla Grip™ Plate, 2.0mm Thickness, Right, Medium
P53-109-R213	Gorilla Grip™ Plate, 2.0mm Thickness, Right, Large
P53-109-R214	Gorilla Grip™ Plate, 2.0mm Thickness, Right, X-Large



Not all products available for sale in all markets. To determine availability in your marketplace, please contact your local Paragon 28 representative or email info@paragon28.com.



Short Plate



Primary Plate



Revision Plate

Graft-Spanning
Plate

Precision® Guide

GORILLA® MTP PLATES

PART NUMBER	DESCRIPTION
P50-900-UNVC-3	Universal Plate System Lid
P50-900-MTPC	Gorilla, Caddy, MTP, Assembly
P01-900-1702	P28, Reamer, MTP, 17mm, Female, SS
P01-900-1703	P28, Reamer, MTP, 17mm, Male, SS
P01-900-1902	P28, Reamer, MTP, 19mm, Female, SS
P01-900-1903	P28, Reamer, MTP, 19mm, Male, SS
P01-900-2102	P28, Reamer, MTP, 21mm, Female, SS
P01-900-2103	P28, Reamer, MTP, 21mm, Male, SS
P01-900-2302	P28, Reamer, MTP, 23mm, Female, SS
P01-900-2303	P28, Reamer, MTP, 23mm, Male, SS
P01-911-1701	P28, SpinGaurd, 17mm, Male, SS
P01-911-1702	P28, SpinGaurd, 17mm, Female, SS
P01-911-1901	P28, SpinGaurd, 19mm, Male, SS
P01-911-1902	P28, SpinGaurd, 19mm, Female, SS
P01-911-2101	P28, SpinGaurd, 21mm, Male, SS
P01-911-2102	P28, SpinGaurd, 21mm, Female, SS
P01-911-2301	P28, SpinGaurd, 23mm, Male, SS
P01-911-2302	P28, SpinGaurd, 23mm, Female, SS
P51-950-0001	Gorilla, Instrument, Precision Guide, Set Screw, Ø1/2" Knob, SS
P51-950-0010	Gorilla, Instrument, Precision Guide, K-wire Sleeve, Ø1.0mm, SS
P51-950-0012	Gorilla, Instrument, Precision Guide, K-wire Sleeve, Ø1.2mm, SS
P51-950-0103-01	Gorilla, Instrument, Precision Guide, MTP, SS
P53-103-L001	Gorilla, Plate, MTP, Primary, Left, 0°, Small, TiA
P53-103-L002	Gorilla, Plate, MTP, Primary, Left, 0°, Med, TiA
P53-103-L003	Gorilla, Plate, MTP, Primary, Left, 0°, Large, TiA
P53-103-L004	Gorilla, Plate, MTP, Short (2 Hole Distal), Left, 0°, Small, TiA
P53-103-L051	Gorilla, Plate, MTP, Primary, Left, 5°, Small, TiA
P53-103-L052	Gorilla, Plate, MTP, Primary, Left, 5°, Med, TiA
P53-103-L053	Gorilla, Plate, MTP, Primary, Left, 5°, Large, TiA

Not all products available for sale in all markets. To determine availability in your marketplace, please contact your local Paragon 28 representative or email info@paragon28.com.

GORILLA® MTP PLATES

PART NUMBER	DESCRIPTION
P53-103-L054	Gorilla, Plate, MTP, Short (2 Hole Distal), Left, 5°, Small, TiA
P53-103-L101	Gorilla, Plate, MTP, Primary, Left, 10°, Small, TiA
P53-103-L102	Gorilla, Plate, MTP, Primary, Left, 10°, Med, TiA
P53-103-L103	Gorilla, Plate, MTP, Primary, Left, 10°, Large, TiA
P53-103-L104	Gorilla, Plate, MTP, Short (2 Hole Distal), Left, 10°, Small, TiA
P53-103-L151	Gorilla, Plate, MTP, Revision, Left, 5°, Small, TiA
P53-103-L152	Gorilla, Plate, MTP, Revision, Left, 5°, Med, TiA
P53-103-L153	Gorilla, Plate, MTP, Revision, Left, 5°, Large, TiA
P53-103-L252	Gorilla, Plate, MTP, Graft Spanning, Left, 5°, Med, TiA
P53-103-R001	Gorilla, Plate, MTP, Primary, Right, 0°, Small, TiA
P53-103-R002	Gorilla, Plate, MTP, Primary, Right, 0°, Med, TiA
P53-103-R003	Gorilla, Plate, MTP, Primary, Right, 0°, Large, TiA
P53-103-R004	Gorilla, Plate, MTP, Short (2 Hole Distal), Right, 0°, Small, TiA
P53-103-R051	Gorilla, Plate, MTP, Primary, Right, 5°, Small, TiA
P53-103-R052	Gorilla, Plate, MTP, Primary, Right, 5°, Med, TiA
P53-103-R053	Gorilla, Plate, MTP, Primary, Right, 5°, Large, TiA
P53-103-R054	Gorilla, Plate, MTP, Short (2 Hole Distal), Right, 5°, Small, TiA
P53-103-R101	Gorilla, Plate, MTP, Primary, Right, 10°, Small, TiA
P53-103-R102	Gorilla, Plate, MTP, Primary, Right, 10°, Med, TiA
P53-103-R103	Gorilla, Plate, MTP, Primary, Right, 10°, Large, TiA
P53-103-R104	Gorilla, Plate, MTP, Short (2 Hole Distal), Right, 10°, Small, TiA
P53-103-R151	Gorilla, Plate, MTP, Revision, Right, 5°, Small, TiA
P53-103-R152	Gorilla, Plate, MTP, Revision, Right, 5°, Med, TiA
P53-103-R153	Gorilla, Plate, MTP, Revision, Right, 5°, Large, TiA
P53-103-R252	Gorilla, Plate, MTP, Graft Spanning, Right, 5°, Med, TiA
P99-192-1615	P28, K-wire, Smooth, Ø1.6 x 150mm, Single Trocar, SS



Not all products available for sale in all markets. To determine availability in your marketplace, please contact your local Paragon 28 representative or email info@paragon28.com.



Small NC Fusion Plate



Medium NC Fusion Plate



Large NC Fusion Plate



Extra Large NC Fusion Plate



Precision® Guide

GORILLA® NC FUSION PLATES

PART NUMBER	DESCRIPTION
P50-900-BOWC-2	Gorilla Half DIN Caddy, Lid
P50-900-NCFS-1	Gorilla, Caddy, Base, NC Fusion
P50-900-NCFS-2	Gorilla, Caddy, Insert, NC Fusion
P53-109-L301	Gorilla, Plate, NC Fusion Medial Column, 1.5mm Thk, Left, Small, TiA
P53-109-L302	Gorilla, Plate, NC Fusion Medial Column, 1.5mm Thk, Left, Medium, TiA
P53-109-L303	Gorilla, Plate, NC Fusion Medial Column, 1.5mm Thk, Left, Large, TiA
P53-109-L304	Gorilla, Plate, NC Fusion Medial Column, 1.5mm Thk, Left, Extra Large, TiA
P53-109-R301	Gorilla, Plate, NC Fusion Medial Column, 1.5mm Thk, Right, Small, TiA
P53-109-R302	Gorilla, Plate, NC Fusion Medial Column, 1.5mm Thk, Right, Medium, TiA
P53-109-R303	Gorilla, Plate, NC Fusion Medial Column, 1.5mm Thk, Right, Large, TiA
P53-109-R304	Gorilla, Plate, NC Fusion Medial Column, 1.5mm Thk, Right, Extra Large, TiA
P51-923-L301	Gorilla, Template, NC Fusion Medial Column, 1.5mm Thk Left, Small, SS
P51-923-L302	Gorilla, Template, NC Fusion Medial Column, 1.5mm Thk Left, Medium, SS
P51-923-L303	Gorilla, Template, NC Fusion Medial Column, 1.5mm Thk Left, Large, SS
P51-923-L304	Gorilla, Template, NC Fusion Medial Column, 1.5mm Thk Left, X-Large, SS
P51-923-R301	Gorilla, Template, NC Fusion Medial Column, 1.5mm Thk Right, Small, SS
P51-923-R302	Gorilla, Template, NC Fusion Medial Column, 1.5mm Thk Right, Medium, SS
P51-923-R303	Gorilla, Template, NC Fusion Medial Column, 1.5mm Thk Right, Large, SS
P51-923-R304	Gorilla, Template, NC Fusion Medial Column, 1.5mm Thk Right, X-Large, SS
P51-950-0012	Gorilla, Instrument, Precision Guide, K-wire Sleeve, Ø1.2mm
P51-950-0014	Gorilla, Instrument, Precision Guide, K-wire Sleeve, Ø1.4mm
P51-950-0016	Gorilla, Instrument, Precision Guide, K-wire Sleeve, Ø1.6mm
P51-951-L109-01	Gorilla, Precision Guide, NC Fusion, Guide Arm Left, SS
P51-951-R109-01	Gorilla, Precision Guide, NC Fusion, Guide Arm Right, SS
P51-950-0002	Gorilla, Instrument, Precision Guide, Set Screw, Ø1/4" Knob
P51-923-0001	Gorilla, Instrument, Reamer, NC Fusion, SS
P99-192-1410	K-wire, 316LVM, Ø1.40mm x 10 cm

Not all products available for sale in all markets. To determine availability in your marketplace, please contact your local Paragon 28 representative or email info@paragon28.com.



HEvans Plate



Trapezoid Plate



Dogbone Plate



Slanted Dogbone Plate



Teddy Bear Plate



28 Plate



T-Plate

GORILLA® UNIVERSAL PLATES

PART NUMBER	DESCRIPTION
P50-900-UNVC-1	Universal Plate System caddy Base
P50-900-UNVC-3	Universal PLate System Lid
P53-101-1012	28 Plate, 20 mm, 2-Hole Compression
P53-101-1021	28 Plate, 15 mm, 2-Hole Compression
P53-101-1022	28 Plate, 20 mm, 2-Hole Compression
P53-101-1023	28 Plate, 25 mm, 2-Hole Compression
P53-101-2011	28 Plate, 15 mm, 2-Hole Locking
P53-101-2012	28 Plate, 20 mm, 2-Hole Locking
P53-101-2013	28 Plate, 25 mm, 2-Hole Locking
P53-101-2021	28 Plate, 15 mm, 2-Hole Locking
P53-101-2022	28 Plate, 20 mm, 2-Hole Locking
P53-101-2023	28 Plate, 25 mm, 2-Hole Locking
P53-101-3011	28 Plate, 25 mm, 3-Hole Compression
P53-101-3012	28 Plate, 30 mm, 3-Hole Compression
P53-101-3021	28 Plate, 25 mm, 3-Hole Compression
P53-101-3022	28 Plate, 30 mm, 3-Hole Compression
P53-101-3023	28 Plate, 35 mm, 3-Hole Compression
P53-101-4121	28 PlateTM, 4-Hole Straight, Locking
P53-101-4021	28 Plate, 4-Hole Straight w/ Compression
P53-101-5021	28 Plate, 5-Hole Straight w/ Compression
P53-105-L001	HEvans Plate, Small, 16mm, Left
P53-105-L002	HEvans Plate, Medium, 20mm, Left
P53-105-L003	HEvans Plate, Long, 24mm, Left
P53-105-R001	HEvans Plate, Small, 16mm, Right

JUMP TO GORILLA PLATES
STERILE PACKAGED PRODUCT

Not all products available for sale in all markets. To determine availability in your marketplace, please contact your local Paragon 28 representative or email info@paragon28.com.



Non-Locking 2.7, 3.5, and 4.2 R3CON Screws



Locking 2.7, 3.5, and 4.2 R3CON Screws

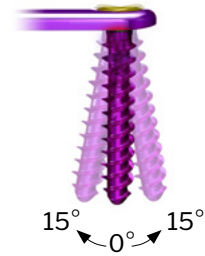

15* Variable Axis

GORILLA® R3CON™ SCREWS

PART NUMBER	DESCRIPTION
P50-900-0005-2	Plate Screw Caddy Lid, Gorilla
P50-900-0009-1	Gorilla R3CON™ Screw Caddy Assembly W/O Lid
P50-153-WS00	Screw Flat/Dome Washer, 2.7, 3.5 & 4.2mm
P50-353-2708	Gorilla R3CON™ Locking Plate Screw, 2.7 X 8mm
P50-353-2709	Gorilla R3CON™ Locking Plate Screw, 2.7 X 9mm
P50-353-2710	Gorilla R3CON™ Locking Plate Screw, 2.7 X 10mm
P50-353-2711	Gorilla R3CON™ Locking Plate Screw, 2.7 X 11mm
P50-353-2712	Gorilla R3CON™ Locking Plate Screw, 2.7 X 12mm
P50-353-2713	Gorilla R3CON™ Locking Plate Screw, 2.7 X 13mm
P50-353-2714	Gorilla R3CON™ Locking Plate Screw, 2.7 X 14mm
P50-353-2715	Gorilla R3CON™ Locking Plate Screw, 2.7 X 15mm
P50-353-2716	Gorilla R3CON™ Locking Plate Screw, 2.7 X 16mm
P50-353-2717	Gorilla R3CON™ Locking Plate Screw, 2.7 X 17mm
P50-353-2718	Gorilla R3CON™ Locking Plate Screw, 2.7 X 18mm
P50-353-2719	Gorilla R3CON™ Locking Plate Screw, 2.7 X 19mm
P50-353-2720	Gorilla R3CON™ Locking Plate Screw, 2.7 X 20mm
P50-353-2722	Gorilla R3CON™ Locking Plate Screw, 2.7 X 22mm
P50-353-2724	Gorilla R3CON™ Locking Plate Screw, 2.7 X 24mm
P50-353-2726	Gorilla R3CON™ Locking Plate Screw, 2.7 X 26mm
P50-353-2728	Gorilla R3CON™ Locking Plate Screw, 2.7 X 28mm
P50-353-2730	Gorilla R3CON™ Locking Plate Screw, 2.7 X 30mm
P50-353-2732	Gorilla R3CON™ Locking Plate Screw, 2.7 X 32mm
P50-353-2734	Gorilla R3CON™ Locking Plate Screw, 2.7 X 34mm
P50-353-2736	Gorilla R3CON™ Locking Plate Screw, 2.7 X 36mm
P50-353-2738	Gorilla R3CON™ Locking Plate Screw, 2.7 X 38mm
P50-353-2740	Gorilla R3CON™ Locking Plate Screw, 2.7 X 40mm
P50-453-2708	Gorilla R3CON™ Non-Locking Plate Screw, 2.7 X 8mm
P50-453-2709	Gorilla R3CON™ Non-Locking Plate Screw, 2.7 X 9mm
P50-453-2710	Gorilla R3CON™ Non-Locking Plate Screw, 2.7 X 10mm

Not all products available for sale in all markets. To determine availability in your marketplace, please contact your local Paragon 28 representative or email info@paragon28.com.

GORILLA® R3CON™ SCREWS

PART NUMBER	DESCRIPTION
P50-453-2711	Gorilla R3CON™ Non-Locking Plate Screw, 2.7 X 11mm
P50-453-2712	Gorilla R3CON™ Non-Locking Plate Screw, 2.7 X 12mm
P50-453-2713	Gorilla R3CON™ Non-Locking Plate Screw, 2.7 X 13mm
P50-453-2714	Gorilla R3CON™ Non-Locking Plate Screw, 2.7 X 14mm
P50-453-2715	Gorilla R3CON™ Non-Locking Plate Screw, 2.7 X 15mm
P50-453-2716	Gorilla R3CON™ Non-Locking Plate Screw, 2.7 X 16mm
P50-453-2717	Gorilla R3CON™ Non-Locking Plate Screw, 2.7 X 17mm
P50-453-2718	Gorilla R3CON™ Non-Locking Plate Screw, 2.7 X 18mm
P50-453-2719	Gorilla R3CON™ Non-Locking Plate Screw, 2.7 X 19mm
P50-453-2720	Gorilla R3CON™ Non-Locking Plate Screw, 2.7 X 20mm
P50-453-2722	Gorilla R3CON™ Non-Locking Plate Screw, 2.7 X 22mm
P50-453-2724	Gorilla R3CON™ Non-Locking Plate Screw, 2.7 X 24mm
P50-453-2726	Gorilla R3CON™ Non-Locking Plate Screw, 2.7 X 26mm
P50-453-2728	Gorilla R3CON™ Non-Locking Plate Screw, 2.7 X 28mm
P50-453-2730	Gorilla R3CON™ Non-Locking Plate Screw, 2.7 X 30mm
P50-453-2732	Gorilla R3CON™ Non-Locking Plate Screw, 2.7 X 32mm
P50-453-2734	Gorilla R3CON™ Non-Locking Plate Screw, 2.7 X 34mm
P50-453-2736	Gorilla R3CON™ Non-Locking Plate Screw, 2.7 X 36mm
P50-453-2738	Gorilla R3CON™ Non-Locking Plate Screw, 2.7 X 38mm
P50-453-2740	Gorilla R3CON™ Non-Locking Plate Screw, 2.7 X 40mm
P50-353-3510	Gorilla R3CON™ Locking Screw 3.5 X 10mm
P50-353-3512	Gorilla R3CON™ Locking Screw 3.5 X 12mm
P50-353-3514	Gorilla R3CON™ Locking Screw 3.5 X 14mm
P50-353-3516	Gorilla R3CON™ Locking Screw 3.5 X 16mm
P50-353-3518	Gorilla R3CON™ Locking Screw 3.5 X 18mm
P50-353-3520	Gorilla R3CON™ Locking Screw 3.5 X 20mm
P50-353-3522	Gorilla R3CON™ Locking Screw 3.5 X 22mm
P50-353-3524	Gorilla R3CON™ Locking Screw 3.5 X 24mm
P50-353-3526	Gorilla R3CON™ Locking Screw 3.5 X 26mm
P50-353-3528	Gorilla R3CON™ Locking Screw 3.5 X 28mm
P50-353-3530	Gorilla R3CON™ Locking Screw 3.5 X 30mm
P50-353-3532	Gorilla R3CON™ Locking Screw 3.5 X 32mm
P50-353-3534	Gorilla R3CON™ Locking Screw 3.5 X 34mm
P50-353-3536	Gorilla R3CON™ Locking Screw 3.5 X 36mm
P50-353-3538	Gorilla R3CON™ Locking Screw 3.5 X 38mm
P50-353-3540	Gorilla R3CON™ Locking Screw 3.5 X 40mm
P50-353-3542	Gorilla R3CON™ Locking Screw 3.5 X 42mm
P50-353-3544	Gorilla R3CON™ Locking Screw 3.5 X 44mm
P50-353-3546	Gorilla R3CON™ Locking Screw 3.5 X 46mm

Not all products available for sale in all markets. To determine availability in your marketplace, please contact your local Paragon 28 representative or email info@paragon28.com.

GORILLA® R3CON™ SCREWS

PART NUMBER	DESCRIPTION
P50-353-3548	Gorilla R3CON™ Locking Screw 3.5 X 48mm
P50-353-3550	Gorilla R3CON™ Locking Screw 3.5 X 50mm
P50-453-3510	Gorilla R3CON™ Non-Locking Screw 3.5 X 10mm
P50-453-3512	Gorilla R3CON™ Non-Locking Screw 3.5 X 12mm
P50-453-3514	Gorilla R3CON™ Non-Locking Screw 3.5 X 14mm
P50-453-3516	Gorilla R3CON™ Non-Locking Screw 3.5 X 16mm
P50-453-3518	Gorilla R3CON™ Non-Locking Screw 3.5 X 18mm
P50-453-3520	Gorilla R3CON™ Non-Locking Screw 3.5 X 20mm
P50-453-3522	Gorilla R3CON™ Non-Locking Screw 3.5 X 22mm
P50-453-3524	Gorilla R3CON™ Non-Locking Screw 3.5 X 24mm
P50-453-3526	Gorilla R3CON™ Non-Locking Screw 3.5 X 26mm
P50-453-3528	Gorilla R3CON™ Non-Locking Screw 3.5 X 28mm
P50-453-3530	Gorilla R3CON™ Non-Locking Screw 3.5 X 30mm
P50-453-3532	Gorilla R3CON™ Non-Locking Screw 3.5 X 32mm
P50-453-3534	Gorilla R3CON™ Non-Locking Screw 3.5 X 34mm
P50-453-3536	Gorilla R3CON™ Non-Locking Screw 3.5 X 36mm
P50-453-3538	Gorilla R3CON™ Non-Locking Screw 3.5 X 38mm
P50-453-3540	Gorilla R3CON™ Non-Locking Screw 3.5 X 40mm
P50-453-3542	Gorilla R3CON™ Non-Locking Screw 3.5 X 42mm
P50-453-3544	Gorilla R3CON™ Non-Locking Screw 3.5 X 44mm
P50-453-3546	Gorilla R3CON™ Non-Locking Screw 3.5 X 46mm
P50-453-3548	Gorilla R3CON™ Non-Locking Screw 3.5 X 48mm
P50-453-3550	Gorilla R3CON™ Non-Locking Screw 3.5 X 50mm
P50-353-4210	Gorilla R3CON™ Locking Screw 4.2 X 10mm
P50-353-4212	Gorilla R3CON™ Locking Screw 4.2 X 12mm
P50-353-4214	Gorilla R3CON™ Locking Screw 4.2 X 14mm
P50-353-4216	Gorilla R3CON™ Locking Screw 4.2 X 16mm
P50-353-4218	Gorilla R3CON™ Locking Screw 4.2 X 18mm
P50-353-4220	Gorilla R3CON™ Locking Screw 4.2 X 20mm
P50-353-4222	Gorilla R3CON™ Locking Screw 4.2 X 22mm
P50-353-4224	Gorilla R3CON™ Locking Screw 4.2 X 24mm
P50-353-4226	Gorilla R3CON™ Locking Screw 4.2 X 26mm
P50-353-4228	Gorilla R3CON™ Locking Screw 4.2 X 28mm
P50-353-4230	Gorilla R3CON™ Locking Screw 4.2 X 30mm
P50-353-4232	Gorilla R3CON™ Locking Screw 4.2 X 32mm
P50-353-4234	Gorilla R3CON™ Locking Screw 4.2 X 34mm
P50-353-4236	Gorilla R3CON™ Locking Screw 4.2 X 36mm
P50-353-4238	Gorilla R3CON™ Locking Screw 4.2 X 38mm
P50-353-4240	Gorilla R3CON™ Locking Screw 4.2 X 40mm
P50-353-4242	Gorilla R3CON™ Locking Screw 4.2 X 42mm

Not all products available for sale in all markets. To determine availability in your marketplace, please contact your local Paragon 28 representative or email info@paragon28.com.

GORILLA® R3CON™ SCREWS

PART NUMBER	DESCRIPTION
P50-353-4244	Gorilla R3CON™ Locking Screw 4.2 X 44mm
P50-353-4246	Gorilla R3CON™ Locking Screw 4.2 X 46mm
P50-353-4248	Gorilla R3CON™ Locking Screw 4.2 X 48mm
P50-353-4250	Gorilla R3CON™ Locking Screw 4.2 X 50mm
P50-353-4255	Gorilla R3CON™ Locking Screw 4.2 X 55mm
P50-353-4260	Gorilla R3CON™ Locking Screw 4.2 X 60mm
P50-353-4265	Gorilla R3CON™ Locking Screw 4.2 X 65mm
P50-353-4270	Gorilla R3CON™ Locking Screw 4.2 X 70mm
P50-453-4210	Gorilla R3CON™ Non-Locking Screw 4.2 X 10mm
P50-453-4212	Gorilla R3CON™ Non-Locking Screw 4.2 X 12mm
P50-453-4214	Gorilla R3CON™ Non-Locking Screw 4.2 X 14mm
P50-453-4216	Gorilla R3CON™ Non-Locking Screw 4.2 X 16mm
P50-453-4218	Gorilla R3CON™ Non-Locking Screw 4.2 X 18mm
P50-453-4220	Gorilla R3CON™ Non-Locking Screw 4.2 X 20mm
P50-453-4222	Gorilla R3CON™ Non-Locking Screw 4.2 X 22mm
P50-453-4224	Gorilla R3CON™ Non-Locking Screw 4.2 X 24mm
P50-453-4226	Gorilla R3CON™ Non-Locking Screw 4.2 X 26mm
P50-453-4228	Gorilla R3CON™ Non-Locking Screw 4.2 X 28mm
P50-453-4230	Gorilla R3CON™ Non-Locking Screw 4.2 X 30mm
P50-453-4232	Gorilla R3CON™ Non-Locking Screw 4.2 X 32mm
P50-453-4234	Gorilla R3CON™ Non-Locking Screw 4.2 X 34mm
P50-453-4236	Gorilla R3CON™ Non-Locking Screw 4.2 X 36mm
P50-453-4238	Gorilla R3CON™ Non-Locking Screw 4.2 X 38mm
P50-453-4240	Gorilla R3CON™ Non-Locking Screw 4.2 X 40mm
P50-453-4242	Gorilla R3CON™ Non-Locking Screw 4.2 X 42mm
P50-453-4244	Gorilla R3CON™ Non-Locking Screw 4.2 X 44mm
P50-453-4246	Gorilla R3CON™ Non-Locking Screw 4.2 X 46mm
P50-453-4248	Gorilla R3CON™ Non-Locking Screw 4.2 X 48mm
P50-453-4250	Gorilla R3CON™ Non-Locking Screw 4.2 X 50mm
P50-453-4255	Gorilla R3CON™ Non-Locking Screw 4.2 X 55mm
P50-453-4260	Gorilla R3CON™ Non-Locking Screw 4.2 X 60mm
P50-453-4265	Gorilla R3CON™ Non-Locking Screw 4.2 X 65mm
P50-453-4270	Gorilla R3CON™ Non-Locking Screw 4.2 X 70mm



Not all products available for sale in all markets. To determine availability in your marketplace, please contact your local Paragon 28 representative or email info@paragon28.com.

GORILLA® R3CON™ INSTRUMENTS

PART NUMBER	DESCRIPTION
P50-900-0008-1	Gorilla R3CON™ General Instrument Caddy Base
P50-900-UNVC-3	Universal Plate System Lid, Gorilla
P99-192-2015	K-Wire, Single Ended Trocar Tip, Smooth, 2.0 X 150 mm
P99-192-2315	K-Wire, Single Ended Trocar Tip, Smooth, 2.3 X 150 mm
P51-900-1001	Locking Drill Guide
P51-900-1002	3.5 Locking Drill Guide
P51-900-1003	4.2 Locking Drill Guide
P51-901-3001	Ez Guide 2.7/3.5
P51-901-3002	2.7/3.5 Cone Guide
P51-901-3042	4.2 Easy/Cone Guide
P51-902-1001	Dril Guide Top Hat, 2.7 mm
P51-902-1002	Dril Guide Top Hat, 3.5 mm
P51-902-1003	Dril Guide Top Hat, 4.2 mm
P51-903-3001	2.7 Compression Slot Gorilla R3CON™, Drill Guide
P51-903-3002	3.5 Compression Slot Gorilla R3CON™, Drill Guide
P51-903-3003	4.2 Compression Slot Gorilla R3CON™, Drill Guide
P51-904-3001	Gorilla R3CON™ Countersink Punch, 2.7-4.2, SS
P51-905-1001	Overdrill Guide
P51-910-1001	Threaded Plate Bending Bar
P51-910-1002	Flat Plate Bender
P51-955-0001	Caspar Insert - Plate Engaging Compression
P99-100-2009	Bone Fenestration Perferator
P99-100-2011	Drill, 2.0 X 110mm, Solid, Measuring, AO
P99-100-2414	P28, Drill Solid 2.4mm X 140mm
P99-100-2711	Over Drill, 2.7 X 110mm, Solid, AO
P99-100-2814	P28 Drill, Solid, 2.8mm X 14Cm SS
P99-100-3511	Over Drill, 3.5 X 110mm, Solid, AO
P99-100-4212	Over Drill, 4.0 X 110mm, Solid, AO
P99-150-0001	Screw Forceps
P99-150-0005	K-Wire Hole Gauge & Ruler (Monster)
P99-150-0014	Depth Gauge Plate Screw, 70mm Screw
P99-150-0035	Bone Fenestration Chisel
P99-191-TR10	Gorilla R3CON™ Driver, Solid, Hx10
P99-200-1406	Olive Wire, Smooth, 1.4mm
P99-201-1406	Olive Wire, Threaded, 1.4mm
P99-202-1810	Olive Wire, Smooth, Short Tip, 1.8mm

Not all products available for sale in all markets. To determine availability in your marketplace, please contact your local Paragon 28 representative or email info@paragon28.com.

GORILLA R3CON PLATING SYSTEM

PART NUMBER	DESCRIPTION
P50-900-0002	Case Base Assembly, Gorilla
P50-900-0003	Implant Caddy Tray, Gorilla
P50-900-0004	Instrument Tray, Gorilla
P50-900-0007	Case Lid, Full DIN
P99-000-AOMN	Mini-AO, Ratchet Handle, Purple
P99-000-AOSS	Handle, Non-Rtch, Streamline Short, AO Pull, Cannulated
P99-150-0004	San Gio Baby Bennetts
P99-150-0011-R	Caspar Type Compression/Distractor Device
P99-150-0013	Sharp Tip Bone Reduction Clamp
P99-150-0015	Medium Hintermann Distractor
P99-150-0017	Lobster Claw
P99-150-0018	Periosteal Elevator
P99-150-0019	Lapidus Ronjeur
P99-150-0034	Cartilage Removal Tool, 8 mm Curved
P99-150-0040	1/4" Osteotome, Straight
P99-150-0041	1/2" Osteotome, Straight
P99-150-0042	3/4" Osteotome, Straight
P99-150-0140	1/4" Osteotome, Curved
P99-150-0141	1/2" Osteotome, Curved
P99-150-0142	3/4" Osteotome, Curved
P99-900-1005	P28 Foot Plate, Plantigrade Guide

Not all products available for sale in all markets. To determine availability in your marketplace, please contact your local Paragon 28 representative or email info@paragon28.com.



Non-Locking 2.7, 3.5, and 4.2 R3CON Screws



Locking 2.7, 3.5, and 4.2 R3CON Screws

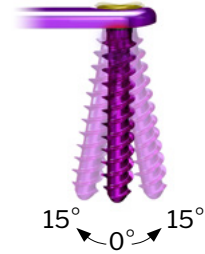

15° Variable Axis

INTERNATIONAL STAINLESS-STEEL GORILLA® R3CON™ PLATE SCREW CADDY

PART NUMBER	DESCRIPTION
P50-901-2009-01	Caddy, Base, Gorilla R3CON™, Screw, Ous
P50-901-2009-02	Caddy, Lid, Gorilla R3CON™, Screw, Ous
P50-353-2708	R3CON™ Locking Plate Screw, 2.7 X 8mm
P50-353-2710	R3CON™ Locking Plate Screw, 2.7 X 10mm
P50-353-2712	R3CON™ Locking Plate Screw, 2.7 X 12mm
P50-353-2714	R3CON™ Locking Plate Screw, 2.7 X 14mm
P50-353-2716	R3CON™ Locking Plate Screw, 2.7 X 16mm
P50-353-2718	R3CON™ Locking Plate Screw, 2.7 X 18mm
P50-353-2720	R3CON™ Locking Plate Screw, 2.7 X 20mm
P50-353-2722	R3CON™ Locking Plate Screw, 2.7 X 22mm
P50-353-2724	R3CON™ Locking Plate Screw, 2.7 X 24mm
P50-353-2726	R3CON™ Locking Plate Screw, 2.7 X 26mm
P50-353-2728	R3CON™ Locking Plate Screw, 2.7 X 28mm
P50-353-2730	R3CON™ Locking Plate Screw, 2.7 X 30mm
P50-453-2708	R3CON™ Non-Locking Plate Screw, 2.7 X 8mm
P50-453-2710	R3CON™ Non-Locking Plate Screw, 2.7 X 10mm
P50-453-2712	R3CON™ Non-Locking Plate Screw, 2.7 X 12mm
P50-453-2714	R3CON™ Non-Locking Plate Screw, 2.7 X 14mm
P50-453-2716	R3CON™ Non-Locking Plate Screw, 2.7 X 16mm
P50-453-2718	R3CON™ Non-Locking Plate Screw, 2.7 X 18mm
P50-453-2720	R3CON™ Non-Locking Plate Screw, 2.7 X 20mm
P50-453-2722	R3CON™ Non-Locking Plate Screw, 2.7 X 22mm
P50-453-2724	R3CON™ Non-Locking Plate Screw, 2.7 X 24mm
P50-453-2726	R3CON™ Non-Locking Plate Screw, 2.7 X 26mm
P50-453-2728	R3CON™ Non-Locking Plate Screw, 2.7 X 28mm
P50-453-2730	R3CON™ Non-Locking Plate Screw, 2.7 X 30mm
P50-353-3510	Gorilla R3CON™ Locking Screw 3.5 X 10mm
P50-353-3512	Gorilla R3CON™ Locking Screw 3.5 X 12mm
P50-353-3514	Gorilla R3CON™ Locking Screw 3.5 X 14mm

Not all products available for sale in all markets. To determine availability in your marketplace, please contact your local Paragon 28 representative or email info@paragon28.com.

INTERNATIONAL STAINLESS-STEEL GORILLA® R3CON™ PLATE SCREW CADDY

PART NUMBER	DESCRIPTION
P50-353-3516	Gorilla R3CON™ Locking Screw 3.5 X 16mm
P50-353-3518	Gorilla R3CON™ Locking Screw 3.5 X 18mm
P50-353-3520	Gorilla R3CON™ Locking Screw 3.5 X 20mm
P50-353-3522	Gorilla R3CON™ Locking Screw 3.5 X 22mm
P50-353-3524	Gorilla R3CON™ Locking Screw 3.5 X 24mm
P50-353-3526	Gorilla R3CON™ Locking Screw 3.5 X 26mm
P50-353-3528	Gorilla R3CON™ Locking Screw 3.5 X 28mm
P50-353-3530	Gorilla R3CON™ Locking Screw 3.5 X 30mm
P50-353-3532	Gorilla R3CON™ Locking Screw 3.5 X 32mm
P50-353-3534	Gorilla R3CON™ Locking Screw 3.5 X 34mm
P50-353-3536	Gorilla R3CON™ Locking Screw 3.5 X 36mm
P50-353-3538	Gorilla R3CON™ Locking Screw 3.5 X 38mm
P50-353-3540	Gorilla R3CON™ Locking Screw 3.5 X 40mm
P50-453-3510	Gorilla R3CON™ Non-Locking Screw 3.5 X 10mm
P50-453-3512	Gorilla R3CON™ Non-Locking Screw 3.5 X 12mm
P50-453-3514	Gorilla R3CON™ Non-Locking Screw 3.5 X 14mm
P50-453-3516	Gorilla R3CON™ Non-Locking Screw 3.5 X 16mm
P50-453-3518	Gorilla R3CON™ Non-Locking Screw 3.5 X 18mm
P50-453-3520	Gorilla R3CON™ Non-Locking Screw 3.5 X 20mm
P50-453-3522	Gorilla R3CON™ Non-Locking Screw 3.5 X 22mm
P50-453-3524	Gorilla R3CON™ Non-Locking Screw 3.5 X 24mm
P50-453-3526	Gorilla R3CON™ Non-Locking Screw 3.5 X 26mm
P50-453-3528	Gorilla R3CON™ Non-Locking Screw 3.5 X 28mm
P50-453-3530	Gorilla R3CON™ Non-Locking Screw 3.5 X 30mm
P50-453-3532	Gorilla R3CON™ Non-Locking Screw 3.5 X 32mm
P50-453-3534	Gorilla R3CON™ Non-Locking Screw 3.5 X 34mm
P50-453-3536	Gorilla R3CON™ Non-Locking Screw 3.5 X 36mm
P50-453-3538	Gorilla R3CON™ Non-Locking Screw 3.5 X 38mm
P50-453-3540	Gorilla R3CON™ Non-Locking Screw 3.5 X 40mm
P50-353-4210	Gorilla R3CON™ Locking Screw 4.2 X 10mm
P50-353-4212	Gorilla R3CON™ Locking Screw 4.2 X 12mm
P50-353-4214	Gorilla R3CON™ Locking Screw 4.2 X 14mm
P50-353-4216	Gorilla R3CON™ Locking Screw 4.2 X 16mm
P50-353-4218	Gorilla R3CON™ Locking Screw 4.2 X 18mm
P50-353-4220	Gorilla R3CON™ Locking Screw 4.2 X 20mm
P50-353-4222	Gorilla R3CON™ Locking Screw 4.2 X 22mm
P50-353-4224	Gorilla R3CON™ Locking Screw 4.2 X 24mm
P50-353-4226	Gorilla R3CON™ Locking Screw 4.2 X 26mm
P50-353-4228	Gorilla R3CON™ Locking Screw 4.2 X 28mm

Not all products available for sale in all markets. To determine availability in your marketplace, please contact your local Paragon 28 representative or email info@paragon28.com.

INTERNATIONAL STAINLESS-STEEL GORILLA® R3CON™ PLATE SCREW CADDY

PART NUMBER	DESCRIPTION
P50-353-4230	Gorilla R3CON™ Locking Screw 4.2 X 30mm
P50-353-4232	Gorilla R3CON™ Locking Screw 4.2 X 32mm
P50-353-4234	Gorilla R3CON™ Locking Screw 4.2 X 34mm
P50-353-4236	Gorilla R3CON™ Locking Screw 4.2 X 36mm
P50-353-4238	Gorilla R3CON™ Locking Screw 4.2 X 38mm
P50-353-4240	Gorilla R3CON™ Locking Screw 4.2 X 40mm
P50-453-4210	Gorilla R3CON™ Non-Locking Screw 4.2 X 10mm
P50-453-4212	Gorilla R3CON™ Non-Locking Screw 4.2 X 12mm
P50-453-4214	Gorilla R3CON™ Non-Locking Screw 4.2 X 14mm
P50-453-4216	Gorilla R3CON™ Non-Locking Screw 4.2 X 16mm
P50-453-4218	Gorilla R3CON™ Non-Locking Screw 4.2 X 18mm
P50-453-4220	Gorilla R3CON™ Non-Locking Screw 4.2 X 20mm
P50-453-4222	Gorilla R3CON™ Non-Locking Screw 4.2 X 22mm
P50-453-4224	Gorilla R3CON™ Non-Locking Screw 4.2 X 24mm
P50-453-4226	Gorilla R3CON™ Non-Locking Screw 4.2 X 26mm
P50-453-4228	Gorilla R3CON™ Non-Locking Screw 4.2 X 28mm
P50-453-4230	Gorilla R3CON™ Non-Locking Screw 4.2 X 30mm
P50-453-4232	Gorilla R3CON™ Non-Locking Screw 4.2 X 32mm
P50-453-4234	Gorilla R3CON™ Non-Locking Screw 4.2 X 34mm
P50-453-4236	Gorilla R3CON™ Non-Locking Screw 4.2 X 36mm
P50-453-4238	Gorilla R3CON™ Non-Locking Screw 4.2 X 38mm
P50-453-4240	Gorilla R3CON™ Non-Locking Screw 4.2 X 40mm
P50-153-WS00	Screw Flat/Dome Washer, 2.7, 3.5 & 4.2mm

Section 2:
BABY GORILLA®
PLATING SYSTEM

Not all products available for sale in all markets. To determine availability in your marketplace, please contact your local Paragon 28 representative or email info@paragon28.com.

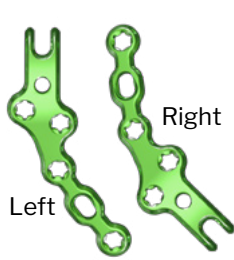

Avulsion
Hook Plates

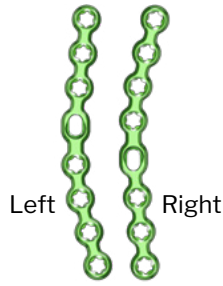

Jones Compression
Plates

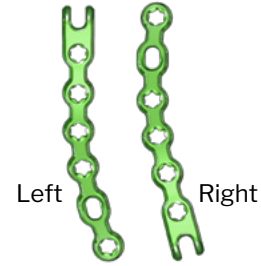

Jones
Hook Plates

BABY GORILLA® 5TH METATARSAL PLATES

PART NUMBER	DESCRIPTION
P50-900-3009-1	Baby Gorilla, 5th Met, Caddy Base
P50-900-SMCL	Baby Gorilla, Small Caddy Lid
P53-007-LC08	Baby Gorilla, Plate, Jones, 8 Hole, Comp., Left, 1.4mm, TiA
P53-007-RC08	Baby Gorilla, Plate, Jones, 8 Hole, Comp., Right, 1.4mm, TiA
P53-008-LC05	Baby Gorilla, Plate, Hook, 5 Hole, Comp., Left, 1.2mm, TiA
P53-008-RC05	Baby Gorilla, Plate, Hook, 5 Hole, Comp., Right, 1.2mm, TiA
P53-008-LC06	Baby Gorilla, Plate, Hook, 6 Hole, Comp., Left, 1.2mm, TiA
P53-008-RC06	Baby Gorilla, Plate, Hook, 6 Hole, Comp., Right, 1.2mm, TiA
P51-921-0001	Baby Gorilla, Tamp, Single Hook
P51-921-0002	Baby Gorilla, Tamp, Double Hook
P51-921-L005	aby Gorilla, 5th Met, Plate Template, 5-Hole, Left
P51-921-R005	Baby Gorilla, 5th Met, Plate Template, 5-Hole, Right
P51-921-L006	Baby Gorilla, 5th Met, Plate Template, 6-Hole, Left
P51-921-R006	Baby Gorilla, 5th Met, Plate Template, 6-Hole, Right
P51-921-0009	Baby Gorilla, 5th Met, Drill Guide, Hook Screw
P51-950-0004	Threaded Knob, M3



Not all products available for sale in all markets. To determine availability in your marketplace, please contact your local Paragon 28 representative or email info@paragon28.com.

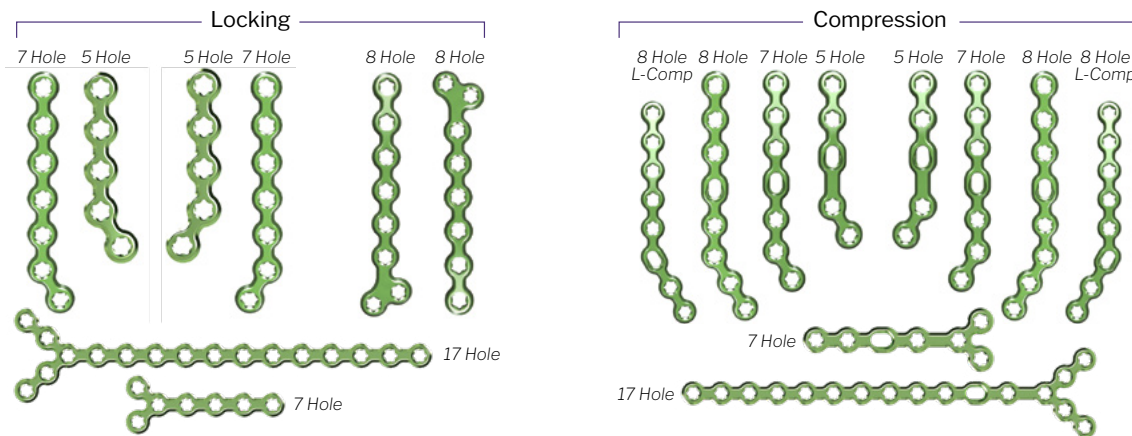

BABY GORILLA® OBLIQUE L-T-Y PLATES

PART NUMBER	DESCRIPTION
P50-900-3007-1	Baby Gorilla, Caddy, Small, Oblique-L-T-Y
P50-900-SMCL	Baby Gorilla, Lid, Small Plate Caddy
P53-002-L005	Baby Gorilla, Plate, Oblique-L2, 05 Hole Locking, Left, 1.1mm, TiA
P53-002-L007	Baby Gorilla, Plate, Oblique-L2, 07 Hole Locking, Left, 1.1mm, TiA
P53-002-R005	Baby Gorilla, Plate, Oblique-L2, 05 Hole Locking, Right, 1.1mm, TiA
P53-002-R007	Baby Gorilla, Plate, Oblique-L2, 07 Hole Locking, Right, 1.1mm, TiA
P53-002-LC05	Baby Gorilla, Plate, Oblique-L2, 05 Hole Compression, Left, 1.1mm, TiA
P53-002-LC07	Baby Gorilla, Plate, Oblique-L2, 07 Hole Compression, Left, 1.1mm, TiA
P53-002-RC05	Baby Gorilla, Plate, Oblique-L2, 05 Hole Compression, Right, 1.1mm, TiA
P53-002-RC07	Baby Gorilla, Plate, Oblique-L2, 07 Hole Compression, Right, 1.1mm, TiA
P53-002-LC38	Baby Gorilla, Plate, Oblique-L3, 08 Hole Compression, Left, 1.1mm, TiA
P53-002-LC83	Baby Gorilla, Plate, Oblique-L3, 08 Hole L-Compression, Left, 1.1mm, TiA
P53-002-RC38	Baby Gorilla, Plate, Oblique-L3, 08 Hole Compression, Right, 1.1mm, TiA
P53-002-RC83	Baby Gorilla, Plate, Oblique-L3, 08 Hole L-Compression, Right, 1.1mm, TiA
P53-004-L008	Baby Gorilla, Plate, Oblique-T2, 08 Hole Locking, Left, 1.1mm, TiA
P53-004-R008	Baby Gorilla, Plate, Oblique-T2, 08 Hole Locking, Right, 1.1mm, TiA
P53-004-LC08	Baby Gorilla, Plate, Oblique-T2, 08 Hole Compression, Left, 1.1mm, TiA
P53-004-RC08	Baby Gorilla, Plate, Oblique-T2, 08 Hole Compression, Right, 1.1mm, TiA
P53-006-3007	Baby Gorilla, Plate, Y3, 07 Hole Locking, 1.1mm, TiA
P53-006-3C07	Baby Gorilla, Plate, Y3, 07 Hole Compression, 1.1mm, TiA
P53-006-5017	Baby Gorilla, Plate, Y5, 17 Hole Locking, 1.4mm, TiA
P53-006-5C17	Baby Gorilla, Plate, Y5, 17 Hole Compression, 1.4mm, TiA

Not all products available for sale in all markets. To determine availability in your marketplace, please contact your local Paragon 28 representative or email info@paragon28.com.

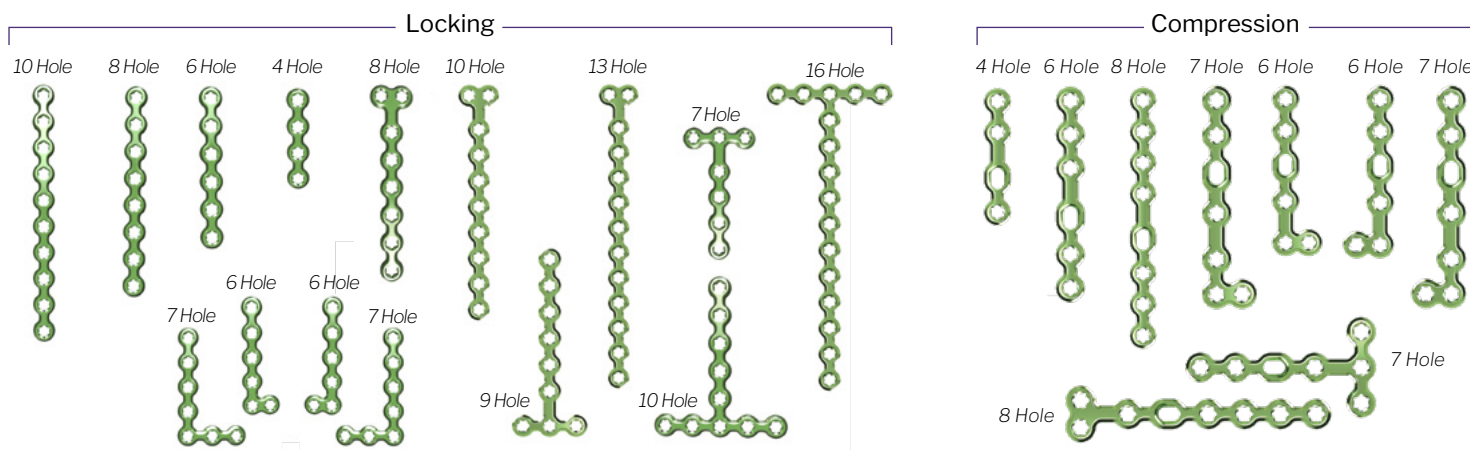

BABY GORILLA® STRAIGHT L-T PLATES

PART NUMBER	DESCRIPTION
P50-900-3006-1	Baby Gorilla, Caddy, Small, Straight-L-T
P50-900-SMCL	Baby Gorilla, Lid, Small Plate Caddy
P53-001-0004	Baby Gorilla, Plate, Straight, 04 Hole Locking, 1.1mm, TiA
P53-001-0006	Baby Gorilla, Plate, Straight, 06 Hole Locking, 1.1mm, TiA
P53-001-0008	Baby Gorilla, Plate, Straight, 08 Hole Locking, 1.1mm, TiA
P53-001-0010	Baby Gorilla, Plate, Straight, 10 Hole Locking, 1.1mm, TiA
P53-001-0C04	Baby Gorilla, Plate, Straight, 04 Hole Compression, 1.1mm, TiA
P53-001-0C06	Baby Gorilla, Plate, Straight, 06 Hole Compression, 1.1mm, TiA
P53-001-0C08	Baby Gorilla, Plate, Straight, 08 Hole Compression, 1.1mm, TiA
P53-003-L006	Baby Gorilla, Plate, L2, 06 Hole Locking, Left, 1.1mm, TiA
P53-003-R006	Baby Gorilla, Plate, L2, 06 Hole Locking, Right, 1.1mm, TiA
P53-003-LC06	Baby Gorilla, Plate, L2, 06 Hole Compression, Left, 1.1mm, TiA
P53-003-RC06	Baby Gorilla, Plate, L2, 06 Hole Compression, Right, 1.1mm, TiA
P53-003-LC27	Baby Gorilla, Plate, L2-2nd Met, 07 Hole Compression, Left, 1.1mm, TiA
P53-003-RC27	Baby Gorilla, Plate, L2-2nd Met, 07 Hole Compression, Right, 1.1mm, TiA
P53-003-L037	Baby Gorilla, Plate, L3, 07 Hole Locking, Left, 1.1mm, TiA
P53-003-R037	Baby Gorilla, Plate, L3, 07 Hole Locking, Right, 1.1mm, TiA
P53-005-0008	Baby Gorilla, Plate, T2, 08 Hole Locking, 1.1mm, TiA
P53-005-0010	Baby Gorilla, Plate, T2, 10 Hole Locking, 1.1mm, TiA
P53-005-0013	Baby Gorilla, Plate, T2, 13 Hole Locking, 1.1mm, TiA
P53-005-0C08	Baby Gorilla, Plate, T2, 08 Hole Compression, 1.1mm, TiA
P53-005-3007	Baby Gorilla, Plate, T3, 07 Hole Locking, 1.1mm, TiA
P53-005-3009	Baby Gorilla, Plate, T3, 09 Hole Locking, 1.1mm, TiA
P53-005-3C07	Baby Gorilla, Plate, T3, 07 Hole Compression, 1.1mm, TiA
P53-005-5010	Baby Gorilla, Plate, T5, 10 Hole Locking, 1.1mm, TiA
P53-005-5016	Baby Gorilla, Plate, T5, 16 Hole Locking, 1.4mm, TiA

JUMP TO BABY GORILLA PLATES
STERILE PACKAGED PRODUCT

Not all products available for sale in all markets. To determine availability in your marketplace, please contact your local Paragon 28 representative or email info@paragon28.com.

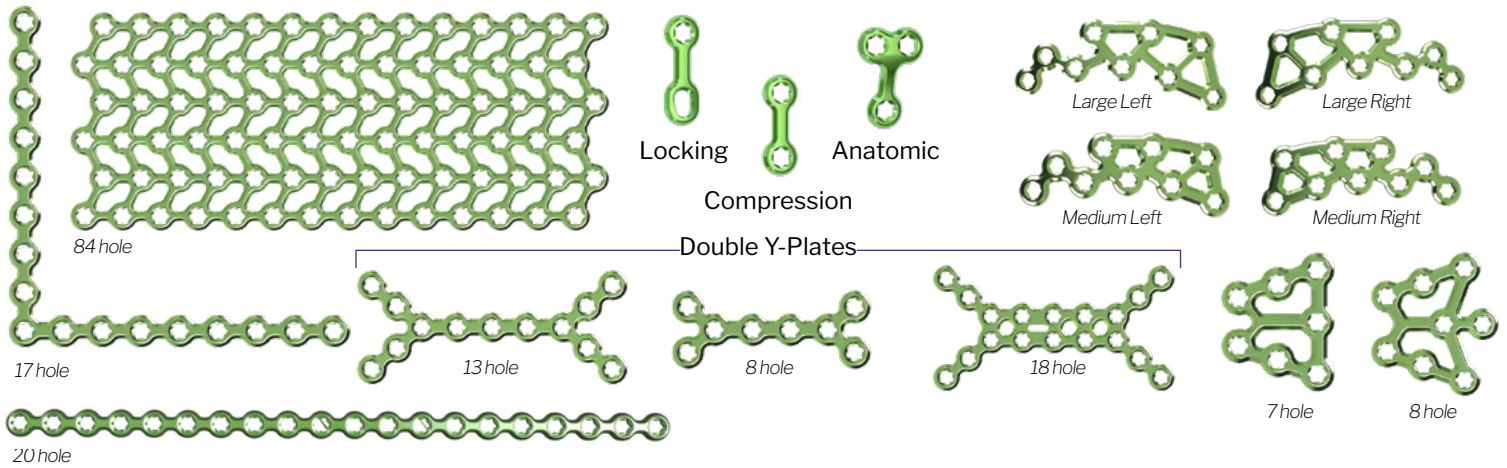

BABY GORILLA® SPECIALTY PLATES

PART NUMBER	DESCRIPTION
P50-900-3008-1	Baby Gorilla, Caddy Base, Small, Specialty Procedure
P50-900-SMCL	Baby Gorilla, Lid, Small Plate Caddy
P53-001-4020	Baby Gorilla, Plate, Straight, 20 Hole Locking, 1.4mm, TiA
P53-001-1010	Baby Gorilla, Plate, Akin, 10mm Locking, 1.1mm, TiA
P53-001-1C10	Baby Gorilla, Plate, Akin, 10mm Compression, 1.1mm, TiA
P53-001-2010	Baby Gorilla, Plate, Anatomical Medial Akin, 10mm Locking, 1.1mm, TiA
P53-003-0099	Baby Gorilla, Plate, L-UNIV, 17 Hole Locking, 1.4mm, TiA
P53-006-0323	Baby Gorilla, Plate, Dub-Y 3-2-3, 8 Hole Locking, 1.1mm, TiA
P53-006-0535	Baby Gorilla, Plate, Dub-Y 5-3-5, 13 Hole Locking, 1.4mm, TiA
P53-006-2666	Baby Gorilla, Plate, Dub-Y 6-6-6, 18 Hole Locking, 1.4mm, TiA
P53-009-L001	Baby Gorilla, Plate, Navicular, 9 Hole Locking, Left, Medium, 1.1mm, TiA
P53-009-L002	Baby Gorilla, Plate, Navicular, 9 Hole Locking, Left, Large, 1.1mm, TiA
P53-009-R001	Baby Gorilla, Plate, Navicular, 9 Hole Locking, Right, Medium, 1.1mm, TiA
P53-009-R002	Baby Gorilla, Plate, Navicular, 9 Hole Locking, Right, Large, 1.1mm, TiA
P53-010-0001	Baby Gorilla, Plate, Cuboid, 07 Locking, Medium, 1.1mm, TiA
P53-010-0002	Baby Gorilla, Plate, Cuboid, 08 Locking, Large, 1.1mm, TiA
P53-012-0614	Baby Gorilla, Plate, Mesh, 6x14 (84) Hole Locking, 1.1mm, TiA

JUMP TO BABY GORILLA PLATES
STERILE PACKAGED PRODUCT

Not all products available for sale in all markets. To determine availability in your marketplace, please contact your local Paragon 28 representative or email info@paragon28.com.



Lateral Talar Neck Plate

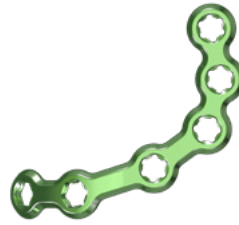

Medial Talar Neck Plate

BABY GORILLA® TALAR NECK FRACTURE PLATES

PART NUMBER	DESCRIPTION
P53-011-L001	Baby Gorilla, Plate, Talar Neck, Lateral, Left, Small, 4-Hole, Locking, 1.4mm Thk, TiA
P53-011-L002	Baby Gorilla, Plate, Talar Neck, Lateral, Left, Medium, 4-Hole, Locking, 1.4mm Thk, TiA
P53-011-R001	Baby Gorilla, Plate, Talar Neck, Lateral, Right, Small, 4-Hole, Locking, 1.4mm Thk, TiA
P53-011-R002	Baby Gorilla, Plate, Talar Neck, Lateral, Right, Medium, 4-Hole, Locking, 1.4mm Thk, TiA
P51-925-0001	Baby Gorilla, Threaded Drill Guide, Long
P51-900-3012-1	Baby Gorilla, Talar Neck Fracture, Caddy Base
P51-900-MNCL	Baby Gorilla, Implant Caddy Lid, Mini

**JUMP TO BABY GORILLA PLATES
STERILE PACKAGED PRODUCT**



Zig-Zag Locking Plate



Span Zig-Zag Locking Plate

BABY GORILLA® ZIG-ZAG PLATES

PART NUMBER	DESCRIPTION
P50-900-3011-1	Baby Gorilla, Plate Caddy, Zig-Zig/Span Implants
P50-900-MNCL	Baby Gorilla, Plate Caddy Lid, Mini
P53-051-0005	Plate, Baby Gorilla, Zig-Zag, 05-Hole, Locking, 1.1mm Thk., TiA
P53-051-0007	Plate, Baby Gorilla, Zig-Zag, 07-Hole, Locking, 1.1mm Thk., TiA
P53-051-0011	Plate, Baby Gorilla, Zig-Zag, 11-Hole, Locking, 1.1mm Thk., TiA
P53-051-0019	Plate, Baby Gorilla, Zig-Zag, 19-Hole, Locking, 1.1mm Thk., TiA
P53-051-1013	Plate, Baby Gorilla, Zig-Zag, Span, 08-Hole, Locking, SM, 1.4mm Thk., TiA
P53-051-1015	Plate, Baby Gorilla, Zig-Zag, Span, 08-Hole, Locking, MD, 1.4mm Thk., TiA
P53-051-1017	Plate, Baby Gorilla, Zig-Zag, Span, 08-Hole, Locking, LG, 1.4mm Thk., TiA

**JUMP TO BABY GORILLA PLATES
STERILE PACKAGED PRODUCT**

Not all products available for sale in all markets. To determine availability in your marketplace, please contact your local Paragon 28 representative or email info@paragon28.com.



BABY GORILLA® SCREWS

PART NUMBER	DESCRIPTION
P50-900-3010-1	Baby Gorilla, Caddy Base, Screw
P50-900-SCCL	Baby Gorilla, Lid, Screw
P50-053-2008	Baby Gorilla, Screw, Ø2.0 x 08mm, Locking, TiA
P50-053-2009	Baby Gorilla, Screw, Ø2.0 x 09mm, Locking, TiA
P50-053-2010	Baby Gorilla, Screw, Ø2.0 x 10mm, Locking, TiA
P50-053-2011	Baby Gorilla, Screw, Ø2.0 x 11mm, Locking, TiA
P50-053-2012	Baby Gorilla, Screw, Ø2.0 x 12mm, Locking, TiA
P50-053-2013	Baby Gorilla, Screw, Ø2.0 x 13mm, Locking, TiA
P50-053-2014	Baby Gorilla, Screw, Ø2.0 x 14mm, Locking, TiA
P50-053-2015	Baby Gorilla, Screw, Ø2.0 x 15mm, Locking, TiA
P50-053-2016	Baby Gorilla, Screw, Ø2.0 x 16mm, Locking, TiA
P50-053-2017	Baby Gorilla, Screw, Ø2.0 x 17mm, Locking, TiA
P50-053-2018	Baby Gorilla, Screw, Ø2.0 x 18mm, Locking, TiA
P50-053-2019	Baby Gorilla, Screw, Ø2.0 x 19mm, Locking, TiA
P50-053-2020	Baby Gorilla, Screw, Ø2.0 x 20mm, Locking, TiA
P50-053-2022	Baby Gorilla, Screw, Ø2.0 x 22mm, Locking, TiA
P50-053-2024	Baby Gorilla, Screw, Ø2.0 x 24mm, Locking, TiA
P50-053-2026	Baby Gorilla, Screw, Ø2.0 x 26mm, Locking, TiA
P50-053-2028	Baby Gorilla, Screw, Ø2.0 x 28mm, Locking, TiA
P50-053-2030	Baby Gorilla, Screw, Ø2.0 x 30mm, Locking, TiA
P50-053-2032	Baby Gorilla, Screw, Ø2.0 x 32mm, Locking, TiA
P50-053-2034	Baby Gorilla, Screw, Ø2.0 x 34mm, Locking, TiA
P50-053-2036	Baby Gorilla, Screw, Ø2.0 x 36mm, Locking, TiA
P50-053-2038	Baby Gorilla, Screw, Ø2.0 x 38mm, Locking, TiA
P50-053-2040	Baby Gorilla, Screw, Ø2.0 x 40mm, Locking, TiA
P50-053-2508	Baby Gorilla, Screw, Ø2.5 x 08mm, Locking, TiA
P50-053-2509	Baby Gorilla, Screw, Ø2.5 x 09mm, Locking, TiA
P50-053-2510	Baby Gorilla, Screw, Ø2.5 x 10mm, Locking, TiA
P50-053-2511	Baby Gorilla, Screw, Ø2.5 x 11mm, Locking, TiA
P50-053-2512	Baby Gorilla, Screw, Ø2.5 x 12mm, Locking, TiA

Not all products available for sale in all markets. To determine availability in your marketplace, please contact your local Paragon 28 representative or email info@paragon28.com.

BABY GORILLA® SCREWS

PART NUMBER	DESCRIPTION
P50-053-2513	Baby Gorilla, Screw, Ø2.5 x 13mm, Locking, TiA
P50-053-2514	Baby Gorilla, Screw, Ø2.5 x 14mm, Locking, TiA
P50-053-2515	Baby Gorilla, Screw, Ø2.5 x 15mm, Locking, TiA
P50-053-2516	Baby Gorilla, Screw, Ø2.5 x 16mm, Locking, TiA
P50-053-2517	Baby Gorilla, Screw, Ø2.5 x 17mm, Locking, TiA
P50-053-2518	Baby Gorilla, Screw, Ø2.5 x 18mm, Locking, TiA
P50-053-2519	Baby Gorilla, Screw, Ø2.5 x 19mm, Locking, TiA
P50-053-2520	Baby Gorilla, Screw, Ø2.5 x 20mm, Locking, TiA
P50-053-2522	Baby Gorilla, Screw, Ø2.5 x 22mm, Locking, TiA
P50-053-2524	Baby Gorilla, Screw, Ø2.5 x 24mm, Locking, TiA
P50-053-2526	Baby Gorilla, Screw, Ø2.5 x 26mm, Locking, TiA
P50-053-2528	Baby Gorilla, Screw, Ø2.5 x 28mm, Locking, TiA
P50-053-2530	Baby Gorilla, Screw, Ø2.5 x 30mm, Locking, TiA
P50-053-2532	Baby Gorilla, Screw, Ø2.5 x 32mm, Locking, TiA
P50-053-2534	Baby Gorilla, Screw, Ø2.5 x 34mm, Locking, TiA
P50-053-2536	Baby Gorilla, Screw, Ø2.5 x 36mm, Locking, TiA
P50-053-2538	Baby Gorilla, Screw, Ø2.5 x 38mm, Locking, TiA
P50-053-2540	Baby Gorilla, Screw, Ø2.5 x 40mm, Locking, TiA
P50-053-2545	Baby Gorilla, Screw, Ø2.5 x 45mm, Locking, TiA
P50-053-2550	Baby Gorilla, Screw, Ø2.5 x 50mm, Locking, TiA
P50-153-2008	Baby Gorilla, Screw, Ø2.0 x 08mm, Non-Locking, TiA
P50-153-2009	Baby Gorilla, Screw, Ø2.0 x 09mm, Non-Locking, TiA
P50-153-2010	Baby Gorilla, Screw, Ø2.0 x 10mm, Non-Locking, TiA
P50-153-2011	Baby Gorilla, Screw, Ø2.0 x 11mm, Non-Locking, TiA
P50-153-2012	Baby Gorilla, Screw, Ø2.0 x 12mm, Non-Locking, TiA
P50-153-2013	Baby Gorilla, Screw, Ø2.0 x 13mm, Non-Locking, TiA
P50-153-2014	Baby Gorilla, Screw, Ø2.0 x 14mm, Non-Locking, TiA
P50-153-2015	Baby Gorilla, Screw, Ø2.0 x 15mm, Non-Locking, TiA
P50-153-2016	Baby Gorilla, Screw, Ø2.0 x 16mm, Non-Locking, TiA
P50-153-2017	Baby Gorilla, Screw, Ø2.0 x 17mm, Non-Locking, TiA
P50-153-2018	Baby Gorilla, Screw, Ø2.0 x 18mm, Non-Locking, TiA
P50-153-2019	Baby Gorilla, Screw, Ø2.0 x 19mm, Non-Locking, TiA
P50-153-2020	Baby Gorilla, Screw, Ø2.0 x 20mm, Non-Locking, TiA
P50-153-2022	Baby Gorilla, Screw, Ø2.0 x 22mm, Non-Locking, TiA
P50-153-2024	Baby Gorilla, Screw, Ø2.0 x 24mm, Non-Locking, TiA
P50-153-2026	Baby Gorilla, Screw, Ø2.0 x 26mm, Non-Locking, TiA
P50-153-2028	Baby Gorilla, Screw, Ø2.0 x 28mm, Non-Locking, TiA
P50-153-2030	Baby Gorilla, Screw, Ø2.0 x 30mm, Non-Locking, TiA
P50-153-2032	Baby Gorilla, Screw, Ø2.0 x 32mm, Non-Locking, TiA
P50-153-2034	Baby Gorilla, Screw, Ø2.0 x 34mm, Non-Locking, TiA

Not all products available for sale in all markets. To determine availability in your marketplace, please contact your local Paragon 28 representative or email info@paragon28.com.

BABY GORILLA® SCREWS

PART NUMBER	DESCRIPTION
P50-153-2036	Baby Gorilla, Screw, Ø2.0 x 36mm, Non-Locking, TiA
P50-153-2038	Baby Gorilla, Screw, Ø2.0 x 38mm, Non-Locking, TiA
P50-153-2040	Baby Gorilla, Screw, Ø2.0 x 40mm, Non-Locking, TiA
P50-153-2508	Baby Gorilla, Screw, Ø2.5 x 08mm, Non-Locking, TiA
P50-153-2509	Baby Gorilla, Screw, Ø2.5 x 09mm, Non-Locking, TiA
P50-153-2510	Baby Gorilla, Screw, Ø2.5 x 10mm, Non-Locking, TiA
P50-153-2511	Baby Gorilla, Screw, Ø2.5 x 11mm, Non-Locking, TiA
P50-153-2512	Baby Gorilla, Screw, Ø2.5 x 12mm, Non-Locking, TiA
P50-153-2513	Baby Gorilla, Screw, Ø2.5 x 13mm, Non-Locking, TiA
P50-153-2514	Baby Gorilla, Screw, Ø2.5 x 14mm, Non-Locking, TiA
P50-153-2515	Baby Gorilla, Screw, Ø2.5 x 15mm, Non-Locking, TiA
P50-153-2516	Baby Gorilla, Screw, Ø2.5 x 16mm, Non-Locking, TiA
P50-153-2517	Baby Gorilla, Screw, Ø2.5 x 17mm, Non-Locking, TiA
P50-153-2518	Baby Gorilla, Screw, Ø2.5 x 18mm, Non-Locking, TiA
P50-153-2519	Baby Gorilla, Screw, Ø2.5 x 19mm, Non-Locking, TiA
P50-153-2520	Baby Gorilla, Screw, Ø2.5 x 20mm, Non-Locking, TiA
P50-153-2522	Baby Gorilla, Screw, Ø2.5 x 22mm, Non-Locking, TiA
P50-153-2524	Baby Gorilla, Screw, Ø2.5 x 24mm, Non-Locking, TiA
P50-153-2526	Baby Gorilla, Screw, Ø2.5 x 26mm, Non-Locking, TiA
P50-153-2528	Baby Gorilla, Screw, Ø2.5 x 28mm, Non-Locking, TiA
P50-153-2530	Baby Gorilla, Screw, Ø2.5 x 30mm, Non-Locking, TiA
P50-153-2532	Baby Gorilla, Screw, Ø2.5 x 32mm, Non-Locking, TiA
P50-153-2534	Baby Gorilla, Screw, Ø2.5 x 34mm, Non-Locking, TiA
P50-153-2536	Baby Gorilla, Screw, Ø2.5 x 36mm, Non-Locking, TiA
P50-153-2538	Baby Gorilla, Screw, Ø2.5 x 38mm, Non-Locking, TiA
P50-153-2540	Baby Gorilla, Screw, Ø2.5 x 40mm, Non-Locking, TiA
P50-153-2545	Baby Gorilla, Screw, Ø2.5 x 45mm, Non-Locking, TiA
P50-153-2550	Baby Gorilla, Screw, Ø2.5 x 50mm, Non-Locking, TiA
P50-153-WM00	Baby Gorilla, Washer
P99-191-SL07	P28, Driver Sleeve, T7, Screw Gripper
P99-191-TS07	P28, Driver, T7

Not all products available for sale in all markets. To determine availability in your marketplace, please contact your local Paragon 28 representative or email info@paragon28.com.

BABY GORILLA® INSTRUMENTS

PART NUMBER	DESCRIPTION
P50-900-3005-1	Baby Gorilla, Caddy Base, Plate Instruments
P50-900-LGCL	Baby Gorilla, Caddy Lid, Large
P51-900-0001	Baby Gorilla, Drill Guide, Threaded, Ø2.0 / 2.5, SS
P51-901-0001	Baby Gorilla, Drill Guide, Double Ended, EZ / Cone, SS
P51-902-0001	Baby Gorilla, Drill Guide, Centering, Ø2.0, SS
P51-902-0002	Baby Gorilla, Drill Guide, Centering, Ø2.5, SS
P51-903-0001	Baby Gorilla, Drill Guide, Compression Slot, Ø2.0 / 2.5, SS
P51-905-0001	Baby Gorilla, Drill Guide, Double Ended, Over Drill (Ø2.0 & Ø2.5), SS
P51-910-0001	Baby Gorilla, Plate Bender, Threaded Bar, SS
P99-100-1310	P28, Drill, Ø1.3 x 100mm (Ø2.0), Solid, SS
P99-100-1611	P28, Drill, Ø1.6 x 110mm (Ø2.5), Solid, SS
P99-100-2109	P28, Over drill, Ø2.1 x 90mm (Ø2.0), Solid, SS
P99-100-2510	Over drill, Ø2.5 x 100mm (Ø2.5), Solid, SS
P99-150-0001	P28, Forceps
P99-150-0005	P28, K-Wire Ruler
P99-150-0007	P28, Dental Pick (Bone Hook)
P99-150-0080	Baby Gorilla, Depth Gauge (50mm)
P99-192-1210	P28, K-wire, Ø1.2 x 100mm, Single Trocar, Smooth SS
P99-192-1615	P28, K-wire, Ø1.6 x 150mm, Single Trocar, Smooth SS
P99-200-1306	P28, Olive Wire, Standard (1.3mm tip), Smooth, SS
P99-201-1306	P28, Olive Wire, Standard (1.3mm tip), Threaded, SS
P99-250-1309	P28, Olive Wire, Through Drill Guide (1.3mm tip), Smooth, SS
P99-250-1606	P28, Olive Wire, Standard (1.6mm tip), Smooth, SS



Not all products available for sale in all markets. To determine availability in your marketplace, please contact your local Paragon 28 representative or email info@paragon28.com.

BABY GORILLA® TRAY

PART NUMBER	DESCRIPTION
P50-900-3001	Baby Gorilla, Case Lid (Full DIN)
P50-900-3002	Baby Gorilla, Case Base (Full DIN)
P50-900-3003	Baby Gorilla, Instrument Tray
P50-900-3004	Baby Gorilla, Implant Caddy Tray
P51-910-0003	Baby Gorilla, Plate Bender, Pliers
P99-000-AORC	Ultra-mini AO Ratchet handle, cannulated
P99-000-AOSS	Mini Streamline AO handle
P99-150-0004	P28, San Gio Baby Bennetts
P99-150-0013	P28, Bone Redcution Clamp
P99-150-0016	P28, Plate Cutter, Double Action
P99-150-0017	P28, Lobster Claw
P99-150-0018	P28, Periosteal Elevator
P99-150-0081	P28, Distractor, Wurapa (1.2mm &1.6mm k-wires)
P99-150-0084	P28, Compressor, Wurapa (1.2mm &1.6mm k-wires)
P99-150-0090	P28, Curette, Small, 20°
P99-150-0091	P28, Curette, Large, 20°
P99-150-0110	P28, Rasp
P99-150-0240	P28, Osteotome, Straight w/Handle, 6mm
P99-150-0241	P28, Osteotome, Straight w/Handle, 9mm
P99-150-0242	P28, Osteotome, Straight w/Handle, 12mm
P99-150-0340	P28, Osteotome, Curved w/Handle, 6mm
P99-150-0341	P28, Osteotome, Curved w/Handle, 9mm
P99-150-0342	P28, Osteotome, Curved w/Handle, 12mm
P99-900-1005	P28, Plantigrade Foot Plate

Section 3:
**SILVERBACK™ ANKLE
FUSION PLATING SYSTEM**

Not all products available for sale in all markets. To determine availability in your marketplace, please contact your local Paragon 28 representative or email info@paragon28.com.

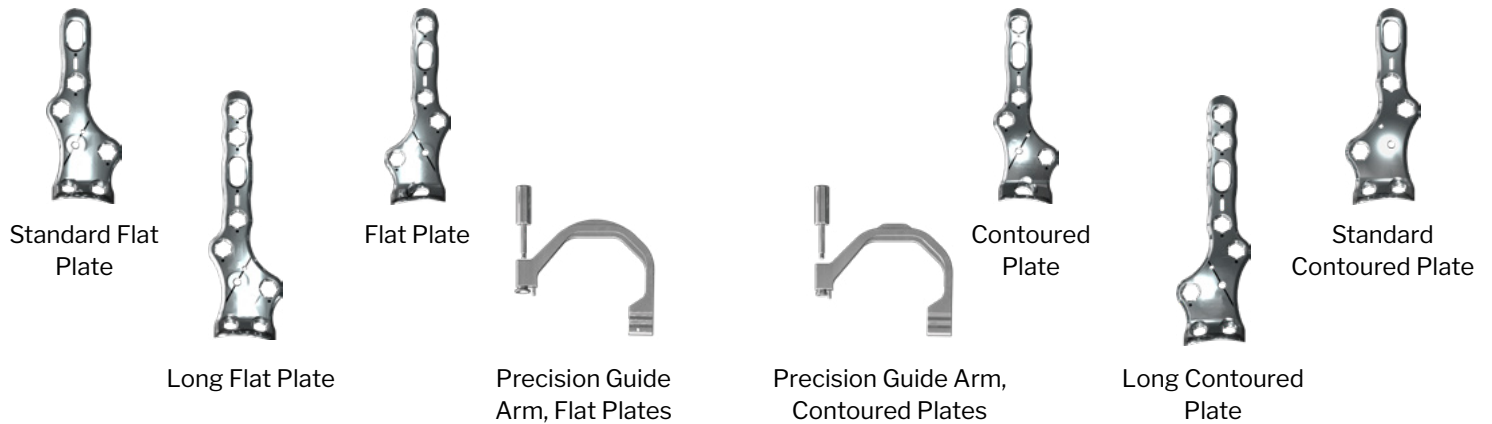

SILVERBACK™ ANKLE FUSION ANTERIOR TT/TTC

PART NUMBER	DESCRIPTION
P51-980-5005	Anterior Plates, Ball Tip Wire Guide
P53-401-L102	Anterior TT Plate, Long, Contoured, Left
P53-401-L202	Anterior TT Plate, Long, Flat, Left
P53-401-R202	Anterior TT Plate, Long, Flat, Right
P53-401-R102	Anterior TT Plate, Long, Right
P53-401-L101	Anterior TT Plate, Standard, Contoured, Left
P53-401-L201	Anterior TT Plate, Standard, Flat, Left
P53-401-R201	Anterior TT Plate, Standard, Flat, Right
P53-401-R101	Anterior TT Plate, Standard, Right
P53-401-L111	Anterior TTC Plate, Contoured, Left
P53-401-R111	Anterior TTC Plate, Contoured, Right
P53-401-L211	Anterior TTC Plate, Flat, Left
P53-401-R211	Anterior TTC Plate, Flat, Right
P51-980-5003	Precision® Guide Set Screw, Silverback
P50-900-SBANT	SILVERBACK™ Anterior Caddy Base
P50-900-SB99	SILVERBACK™ Caddy Base Lid 9 X 9 Caddy
P51-980-5001	Precision® Guide Arm
P51-980-5101	Precision® Guide Arm, Flat Plates
P51-980-5010-16	Precision® Guide K-Wire Sleeve, 1.6mm
P51-980-5010-23	Precision® Guide K-Wire Sleeve, 2.3mm

Not all products available for sale in all markets. To determine availability in your marketplace, please contact your local Paragon 28 representative or email info@paragon28.com.

Lateral TT Plates



Standard Plate

Lateral TTC Plates



Standard Plate



Long Plate



Precision Guide Arm, Flat Plates



Precision Guide Arm, Contoured Plates

SILVERBACK™ ANKLE FUSION LATERAL TT/TTC PLATES

PART NUMBER	DESCRIPTION
P53-402-L001	Lateral TT Plate, Standard, Left
P53-402-R001	Lateral TT Plate, Standard, Right
P53-402-L101	Lateral TTC Plate, Standard, Left
P53-402-R101	Lateral TTC Plate, Standard, Right
P53-402-L102	Lateral TTC Plate, Long, Left
P53-402-R102	Lateral TTC Plate, Long, Right
P51-981-5001	Precision Guide, Tibiotalar Joint, Guide Arm
P51-981-510R	Precision Guide, Subtalar Joint, Guide Arm, Right
P51-981-510L	Precision Guide, Subtalar Joint, Guide Arm, Left
P51-980-5003	Precision Guide Set Screw, M3, Threaded
P51-980-5010-16	Precision Guide K-Wire Tube, 1.6mm
P51-980-5010-23	Precision Guide K-Wire Tube, 2.3mm
P50-900-SBLAT	Silverback Gorilla, Caddy Base, Lateral Plates
P50-900-SB99	Silverback Gorilla, Caddy Lid, 9x9

Not all products available for sale in all markets. To determine availability in your marketplace, please contact your local Paragon 28 representative or email info@paragon28.com.

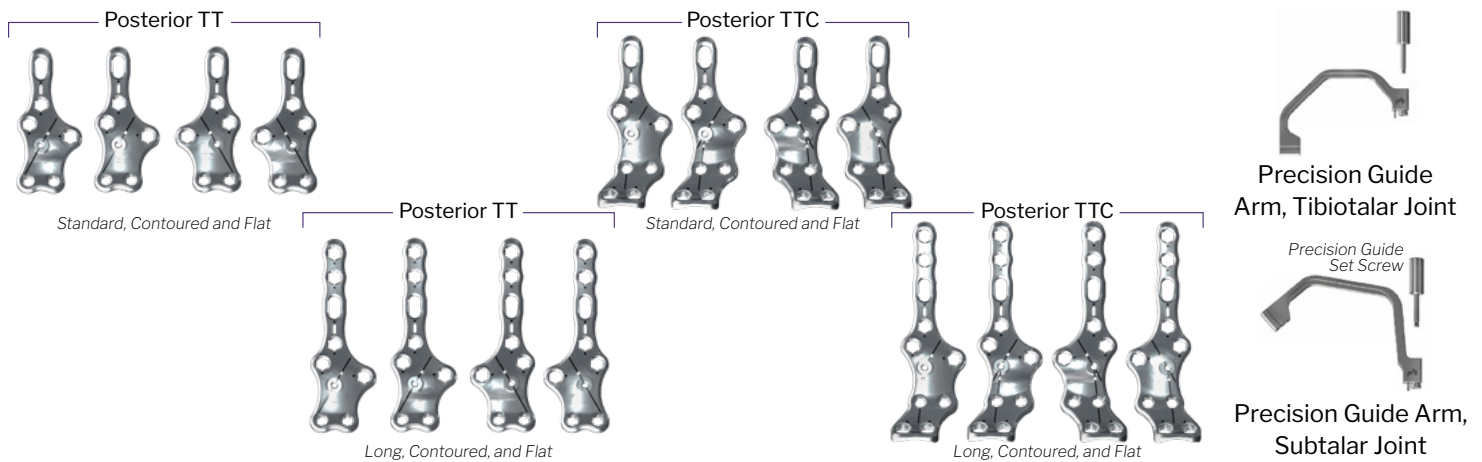

SILVERBACK™ ANKLE FUSION POSTERIOR TT & TTC PLATES

PART NUMBER	DESCRIPTION
P53-403-L101	Posterior TT Plate, Standard, Contoured, Left, 06-Hole, TiA
P53-403-L102	Posterior TT Plate, Long, Contoured, Left, 08-Hole, TiA
P53-403-R101	Posterior TT Plate, Standard, Contoured, Right, 06-Hole, TiA
P53-403-R102	Posterior TT Plate, Long, Contoured, Right, 08-Hole, TiA
P53-403-L201	Posterior TT Plate, Standard, Flat, Left, 06-Hole, TiA
P53-403-L202	Posterior TT Plate, Long, Flat, Left, 08-Hole, TiA
P53-403-R201	Posterior TT Plate, Standard, Flat, Right, 06-Hole, TiA
P53-403-R202	Posterior TT Plate, Long, Flat, Right, 08-Hole, TiA
P53-403-L111	Posterior TTC Plate, Standard, Contoured, Left, 08-Hole, TiA
P53-403-L112	Posterior TTC Plate, Long, Contoured, Left, 10-Hole, TiA
P53-403-R111	Posterior TTC Plate, Standard, Contoured, Right, 08-Hole, TiA
P53-403-R112	Posterior TTC Plate, Long, Contoured, Right, 10-Hole, TiA
P53-403-L211	Posterior TTC Plate, Standard, Flat, Left, 08-Hole, TiA
P53-403-L212	Posterior TTC Plate, Long, Flat, Left, 10-Hole, TiA
P53-403-R211	Posterior TTC Plate, Standard, Flat, Right, 08-Hole, TiA
P53-403-R212	Posterior TTC Plate, Long, Flat, Right, 10-Hole, TiA
P51-982-5001	Precision Guide, Tibiotalar Joint, Guide Arm
P51-982-5101	Precision Guide, Subtalar Joint, Guide Arm
P51-980-5003	Precision Guide Set Screw, M3, Threaded
P51-980-5010-16	Precision Guide K-Wire Tube, 1.6mm
P51-980-5010-23	Precision Guide K-Wire Tube, 2.3mm
P50-900-SBPOS	Silverback Gorilla, Caddy Base, Posterior Plates
P50-900-SB99	Silverback Gorilla, Caddy Lid, 9x9

Not all products available for sale in all markets. To determine availability in your marketplace, please contact your local Paragon 28 representative or email info@paragon28.com.



ø3.5mm Locking
and Nonlocking
R3CON Screws

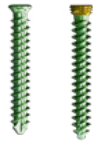

ø4.2mm Locking
and Nonlocking
R3CON Screws

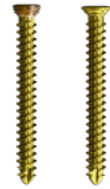

ø4.5mm Locking
and Nonlocking
SILVERBACK Screws



ø5.2mm Locking
and Nonlocking
SILVERBACK
Screws

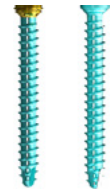

ø4.7mm Locking
and Nonlocking
SILVERBACK
Compact Screws

SILVERBACK™ ANKLE FUSION SCREWS

PART NUMBER	DESCRIPTION
P50-900-1004-1	Silverback, Ankle Fusion, Screw Caddy, Base
P50-900-1004-2	Silverback, Ankle Fusion, Screw Caddy, Lid
P50-153-WS00	Screw Flat/Dome Washer, 2.7, 3.5 & 4.2mm
P50-153-WB00	Screw Flat/Dome Washer, 4.5, & 5.2mm
P50-353-3514	R3CON™ Locking Plate Screw, 3.5 x 14mm
P50-353-3516	R3CON™ Locking Plate Screw, 3.5 x 16mm
P50-353-3518	R3CON™ Locking Plate Screw, 3.5 x 18mm
P50-353-3520	R3CON™ Locking Plate Screw, 3.5 x 20mm
P50-353-3522	R3CON™ Locking Plate Screw, 3.5 x 22mm
P50-353-3524	R3CON™ Locking Plate Screw, 3.5 x 24mm
P50-353-3526	R3CON™ Locking Plate Screw, 3.5 x 26mm
P50-353-3528	R3CON™ Locking Plate Screw, 3.5 x 28mm
P50-353-3530	R3CON™ Locking Plate Screw, 3.5 x 30mm
P50-453-3514	R3CON™ Non-Locking Plate Screw, 3.5 x 14mm
P50-453-3516	R3CON™ Non-Locking Plate Screw, 3.5 x 16mm
P50-453-3518	R3CON™ Non-Locking Plate Screw, 3.5 x 18mm
P50-453-3520	R3CON™ Non-Locking Plate Screw, 3.5 x 20mm
P50-453-3522	R3CON™ Non-Locking Plate Screw, 3.5 x 22mm
P50-453-3524	R3CON™ Non-Locking Plate Screw, 3.5 x 24mm
P50-453-3526	R3CON™ Non-Locking Plate Screw, 3.5 x 26mm
P50-453-3528	R3CON™ Non-Locking Plate Screw, 3.5 x 28mm
P50-453-3530	R3CON™ Non-Locking Plate Screw, 3.5 x 30mm
P50-353-4214	R3CON™ Locking Plate Screw, 4.2 x 14mm
P50-353-4216	R3CON™ Locking Plate Screw, 4.2 x 16mm
P50-353-4218	R3CON™ Locking Plate Screw, 4.2 x 18mm
P50-353-4220	R3CON™ Locking Plate Screw, 4.2 x 20mm
P50-353-4222	R3CON™ Locking Plate Screw, 4.2 x 22mm
P50-353-4224	R3CON™ Locking Plate Screw, 4.2 x 24mm
P50-353-4226	R3CON™ Locking Plate Screw, 4.2 x 26mm
P50-353-4228	R3CON™ Locking Plate Screw, 4.2 x 28mm

Not all products available for sale in all markets. To determine availability in your marketplace, please contact your local Paragon 28 representative or email info@paragon28.com.

SILVERBACK™ ANKLE FUSION SCREWS

PART NUMBER	DESCRIPTION
P50-353-4230	R3CON™ Locking Plate Screw, 4.2 x 30mm
P50-353-4232	R3CON™ Locking Plate Screw, 4.2 x 32mm
P50-353-4234	R3CON™ Locking Plate Screw, 4.2 x 34mm
P50-353-4236	R3CON™ Locking Plate Screw, 4.2 x 36mm
P50-353-4238	R3CON™ Locking Plate Screw, 4.2 x 38mm
P50-353-4240	R3CON™ Locking Plate Screw, 4.2 x 40mm
P50-353-4242	R3CON™ Locking Plate Screw, 4.2 x 42mm
P50-353-4244	R3CON™ Locking Plate Screw, 4.2 x 44mm
P50-353-4246	R3CON™ Locking Plate Screw, 4.2 x 46mm
P50-353-4248	R3CON™ Locking Plate Screw, 4.2 x 48mm
P50-353-4250	R3CON™ Locking Plate Screw, 4.2 x 50mm
P50-353-4255	R3CON™ Locking Plate Screw, 4.2 x 55mm
P50-353-4260	R3CON™ Locking Plate Screw, 4.2 x 60mm
P50-453-4214	R3CON™ Non-Locking Plate Screw, 4.2 x 14mm
P50-453-4216	R3CON™ Non-Locking Plate Screw, 4.2 x 16mm
P50-453-4218	R3CON™ Non-Locking Plate Screw, 4.2 x 18mm
P50-453-4220	R3CON™ Non-Locking Plate Screw, 4.2 x 20mm
P50-453-4222	R3CON™ Non-Locking Plate Screw, 4.2 x 22mm
P50-453-4224	R3CON™ Non-Locking Plate Screw, 4.2 x 24mm
P50-453-4226	R3CON™ Non-Locking Plate Screw, 4.2 x 26mm
P50-453-4228	R3CON™ Non-Locking Plate Screw, 4.2 x 28mm
P50-453-4230	R3CON™ Non-Locking Plate Screw, 4.2 x 30mm
P50-453-4232	R3CON™ Non-Locking Plate Screw, 4.2 x 32mm
P50-453-4234	R3CON™ Non-Locking Plate Screw, 4.2 x 34mm
P50-453-4236	R3CON™ Non-Locking Plate Screw, 4.2 x 36mm
P50-453-4238	R3CON™ Non-Locking Plate Screw, 4.2 x 38mm
P50-453-4240	R3CON™ Non-Locking Plate Screw, 4.2 x 40mm
P50-453-4242	R3CON™ Non-Locking Plate Screw, 4.2 x 42mm
P50-453-4244	R3CON™ Non-Locking Plate Screw, 4.2 x 44mm
P50-453-4246	R3CON™ Non-Locking Plate Screw, 4.2 x 46mm
P50-453-4248	R3CON™ Non-Locking Plate Screw, 4.2 x 48mm
P50-453-4250	R3CON™ Non-Locking Plate Screw, 4.2 x 50mm
P50-453-4255	R3CON™ Non-Locking Plate Screw, 4.2 x 55mm
P50-453-4260	R3CON™ Non-Locking Plate Screw, 4.2 x 60mm
P50-553-4514	SILVERBACK™ Locking Plate Screw, 4.5 x 14mm
P50-553-4516	SILVERBACK™ Locking Plate Screw, 4.5 x 16mm
P50-553-4518	SILVERBACK™ Locking Plate Screw, 4.5 x 18mm
P50-553-4520	SILVERBACK™ Locking Plate Screw, 4.5 x 20mm
P50-553-4522	SILVERBACK™ Locking Plate Screw, 4.5 x 22mm
P50-553-4524	SILVERBACK™ Locking Plate Screw, 4.5 x 24mm

Not all products available for sale in all markets. To determine availability in your marketplace, please contact your local Paragon 28 representative or email info@paragon28.com.

SILVERBACK™ ANKLE FUSION SCREWS

PART NUMBER	DESCRIPTION
P50-553-4526	SILVERBACK™ Locking Plate Screw, 4.5 x 26mm
P50-553-4528	SILVERBACK™ Locking Plate Screw, 4.5 x 28mm
P50-553-4530	SILVERBACK™ Locking Plate Screw, 4.5 x 30mm
P50-553-4532	SILVERBACK™ Locking Plate Screw, 4.5 x 32mm
P50-553-4534	SILVERBACK™ Locking Plate Screw, 4.5 x 34mm
P50-553-4536	SILVERBACK™ Locking Plate Screw, 4.5 x 36mm
P50-553-4538	SILVERBACK™ Locking Plate Screw, 4.5 x 38mm
P50-553-4540	SILVERBACK™ Locking Plate Screw, 4.5 x 40mm
P50-553-4542	SILVERBACK™ Locking Plate Screw, 4.5 x 42mm
P50-553-4544	SILVERBACK™ Locking Plate Screw, 4.5 x 44mm
P50-553-4546	SILVERBACK™ Locking Plate Screw, 4.5 x 46mm
P50-553-4548	SILVERBACK™ Locking Plate Screw, 4.5 x 48mm
P50-553-4550	SILVERBACK™ Locking Plate Screw, 4.5 x 50mm
P50-553-4555	SILVERBACK™ Locking Plate Screw, 4.5 x 55mm
P50-553-4560	SILVERBACK™ Locking Plate Screw, 4.5 x 60mm
P50-653-4514	SILVERBACK™ Non-Locking Plate Screw, 4.5 x 14mm
P50-653-4516	SILVERBACK™ Non-Locking Plate Screw, 4.5 x 16mm
P50-653-4518	SILVERBACK™ Non-Locking Plate Screw, 4.5 x 18mm
P50-653-4520	SILVERBACK™ Non-Locking Plate Screw, 4.5 x 20mm
P50-653-4522	SILVERBACK™ Non-Locking Plate Screw, 4.5 x 22mm
P50-653-4524	SILVERBACK™ Non-Locking Plate Screw, 4.5 x 24mm
P50-653-4526	SILVERBACK™ Non-Locking Plate Screw, 4.5 x 26mm
P50-653-4528	SILVERBACK™ Non-Locking Plate Screw, 4.5 x 28mm
P50-653-4530	SILVERBACK™ Non-Locking Plate Screw, 4.5 x 30mm
P50-653-4532	SILVERBACK™ Non-Locking Plate Screw, 4.5 x 32mm
P50-653-4534	SILVERBACK™ Non-Locking Plate Screw, 4.5 x 34mm
P50-653-4536	SILVERBACK™ Non-Locking Plate Screw, 4.5 x 36mm
P50-653-4538	SILVERBACK™ Non-Locking Plate Screw, 4.5 x 38mm
P50-653-4540	SILVERBACK™ Non-Locking Plate Screw, 4.5 x 40mm
P50-653-4542	SILVERBACK™ Non-Locking Plate Screw, 4.5 x 42mm
P50-653-4544	SILVERBACK™ Non-Locking Plate Screw, 4.5 x 44mm
P50-653-4546	SILVERBACK™ Non-Locking Plate Screw, 4.5 x 46mm
P50-653-4548	SILVERBACK™ Non-Locking Plate Screw, 4.5 x 48mm
P50-653-4550	SILVERBACK™ Non-Locking Plate Screw, 4.5 x 50mm
P50-653-4555	SILVERBACK™ Non-Locking Plate Screw, 4.5 x 55mm
P50-653-4560	SILVERBACK™ Non-Locking Plate Screw, 4.5 x 60mm
P50-553-5214	SILVERBACK™ Locking Plate Screw, 5.2 x 14mm
P50-553-5216	SILVERBACK™ Locking Plate Screw, 5.2 x 16mm
P50-553-5218	SILVERBACK™ Locking Plate Screw, 5.2 x 18mm
P50-553-5220	SILVERBACK™ Locking Plate Screw, 5.2 x 20mm

Not all products available for sale in all markets. To determine availability in your marketplace, please contact your local Paragon 28 representative or email info@paragon28.com.

SILVERBACK™ ANKLE FUSION SCREWS

PART NUMBER	DESCRIPTION
P50-553-5222	SILVERBACK™ Locking Plate Screw, 5.2 x 22mm
P50-553-5224	SILVERBACK™ Locking Plate Screw, 5.2 x 24mm
P50-553-5226	SILVERBACK™ Locking Plate Screw, 5.2 x 26mm
P50-553-5228	SILVERBACK™ Locking Plate Screw, 5.2 x 28mm
P50-553-5230	SILVERBACK™ Locking Plate Screw, 5.2 x 30mm
P50-553-5232	SILVERBACK™ Locking Plate Screw, 5.2 x 32mm
P50-553-5234	SILVERBACK™ Locking Plate Screw, 5.2 x 34mm
P50-553-5236	SILVERBACK™ Locking Plate Screw, 5.2 x 36mm
P50-553-5238	SILVERBACK™ Locking Plate Screw, 5.2 x 38mm
P50-553-5240	SILVERBACK™ Locking Plate Screw, 5.2 x 40mm
P50-553-5242	SILVERBACK™ Locking Plate Screw, 5.2 x 42mm
P50-553-5244	SILVERBACK™ Locking Plate Screw, 5.2 x 44mm
P50-553-5246	SILVERBACK™ Locking Plate Screw, 5.2 x 46mm
P50-553-5248	SILVERBACK™ Locking Plate Screw, 5.2 x 48mm
P50-553-5250	SILVERBACK™ Locking Plate Screw, 5.2 x 50mm
P50-553-5255	SILVERBACK™ Locking Plate Screw, 5.2 x 55mm
P50-553-5260	SILVERBACK™ Locking Plate Screw, 5.2 x 60mm
P50-653-5214	SILVERBACK™ Non-Locking Plate Screw, 5.2 x 14mm
P50-653-5216	SILVERBACK™ Non-Locking Plate Screw, 5.2 x 16mm
P50-653-5218	SILVERBACK™ Non-Locking Plate Screw, 5.2 x 18mm
P50-653-5220	SILVERBACK™ Non-Locking Plate Screw, 5.2 x 20mm
P50-653-5222	SILVERBACK™ Non-Locking Plate Screw, 5.2 x 22mm
P50-653-5224	SILVERBACK™ Non-Locking Plate Screw, 5.2 x 24mm
P50-653-5226	SILVERBACK™ Non-Locking Plate Screw, 5.2 x 26mm
P50-653-5228	SILVERBACK™ Non-Locking Plate Screw, 5.2 x 28mm
P50-653-5230	SILVERBACK™ Non-Locking Plate Screw, 5.2 x 30mm
P50-653-5232	SILVERBACK™ Non-Locking Plate Screw, 5.2 x 32mm
P50-653-5234	SILVERBACK™ Non-Locking Plate Screw, 5.2 x 34mm
P50-653-5236	SILVERBACK™ Non-Locking Plate Screw, 5.2 x 36mm
P50-653-5238	SILVERBACK™ Non-Locking Plate Screw, 5.2 x 38mm
P50-653-5240	SILVERBACK™ Non-Locking Plate Screw, 5.2 x 40mm
P50-653-5242	SILVERBACK™ Non-Locking Plate Screw, 5.2 x 42mm
P50-653-5244	SILVERBACK™ Non-Locking Plate Screw, 5.2 x 44mm
P50-653-5246	SILVERBACK™ Non-Locking Plate Screw, 5.2 x 46mm
P50-653-5248	SILVERBACK™ Non-Locking Plate Screw, 5.2 x 48mm
P50-653-5250	SILVERBACK™ Non-Locking Plate Screw, 5.2 x 50mm
P50-653-5255	SILVERBACK™ Non-Locking Plate Screw, 5.2 x 55mm
P50-653-5260	SILVERBACK™ Non-Locking Plate Screw, 5.2 x 60mm
P50-753-4720	SILVERBACK™ Locking Plate Screw, 4.7 x 20mm
P50-753-4722	SILVERBACK™ Locking Plate Screw, 4.7 x 22mm

Not all products available for sale in all markets. To determine availability in your marketplace, please contact your local Paragon 28 representative or email info@paragon28.com.

SILVERBACK™ ANKLE FUSION SCREWS

PART NUMBER	DESCRIPTION
P50-753-4724	SILVERBACK™ Locking Plate Screw, 4.7 x 24mm
P50-753-4726	SILVERBACK™ Locking Plate Screw, 4.7 x 26mm
P50-753-4728	SILVERBACK™ Locking Plate Screw, 4.7 x 28mm
P50-753-4730	SILVERBACK™ Locking Plate Screw, 4.7 x 30mm
P50-753-4732	SILVERBACK™ Locking Plate Screw, 4.7 x 32mm
P50-753-4734	SILVERBACK™ Locking Plate Screw, 4.7 x 34mm
P50-753-4736	SILVERBACK™ Locking Plate Screw, 4.7 x 36mm
P50-753-4738	SILVERBACK™ Locking Plate Screw, 4.7 x 38mm
P50-753-4740	SILVERBACK™ Locking Plate Screw, 4.7 x 40mm
P50-853-4720	SILVERBACK™ Non-Locking Plate Screw, 4.7 x 20mm
P50-853-4722	SILVERBACK™ Non-Locking Plate Screw, 4.7 x 22mm
P50-853-4724	SILVERBACK™ Non-Locking Plate Screw, 4.7 x 24mm
P50-853-4726	SILVERBACK™ Non-Locking Plate Screw, 4.7 x 26mm
P50-853-4728	SILVERBACK™ Non-Locking Plate Screw, 4.7 x 28mm
P50-853-4730	SILVERBACK™ Non-Locking Plate Screw, 4.7 x 30mm
P50-853-4732	SILVERBACK™ Non-Locking Plate Screw, 4.7 x 32mm
P50-853-4734	SILVERBACK™ Non-Locking Plate Screw, 4.7 x 34mm
P50-853-4736	SILVERBACK™ Non-Locking Plate Screw, 4.7 x 36mm
P50-853-4738	SILVERBACK™ Non-Locking Plate Screw, 4.7 x 38mm
P50-853-4740	SILVERBACK™ Non-Locking Plate Screw, 4.7 x 40mm



Not all products available for sale in all markets. To determine availability in your marketplace, please contact your local Paragon 28 representative or email info@paragon28.com.

SILVERBACK™ K-WIRES & OLIVE WIRES

PART NUMBER	DESCRIPTION
P99-193-2515	K-Wire, Single Ended Trocar Tip, Threaded, 2.5 x 150mm
P99-204-1608	Half Olive Wire, Large Olive (7mm), 1.6 x 80mm, Smooth
P99-205-1608	Half Olive Wire, Large Olive (7mm), 1.6 x 80mm, Threaded
P99-204-1609	Half Olive Wire, Large Olive (7mm), 1.6 x 92mm, Smooth
P99-205-1609	Half Olive Wire, Large Olive (7mm), 1.6 x 92mm, Threaded
P50-900-KWCB	SILVERBACK, K-Wire Caddy, Base
P50-900-KWCL	SILVERBACK, K-Wire Caddy, Lid
P99-150-0005	K-Wire Hole Gauge & Ruler
P99-192-2020	K-Wire, Single Ended Trocar Tip, SMOOTH, 2.0 x 200mm
P99-192-2515	K-Wire, Single Ended Trocar Tip, SMOOTH, 2.5 x 150mm
P99-193-2020	K-Wire, Single Ended Trocar Tip, THREADED, 2.0 x 200mm

Not all products available for sale in all markets. To determine availability in your marketplace, please contact your local Paragon 28 representative or email info@paragon28.com.

SILVERBACK™ INSTRUMENTS

PART NUMBER	DESCRIPTION
P51-911-4700	Tap, Single Lead, ø4.7mm
P99-150-0001	Screw Forceps
P99-191-LR10	Screw Driver Attachment, Solid, Long, AO, HX-10, Short Taper, R3CON™
P99-191-SB15	Screw Driver Attachment, Solid, Long, AO, HX-15, Short Taper, SILVERBACK™
P51-900-1005	3.5 Locking Drill Guide, Long, R3CON™
P51-900-1006	4.2 Locking Drill Guide, Long, R3CON™
P51-900-5005	4.5 Locking Drill Guide, Long, Silverback
P51-903-5005	4.5mm Compression Slot Drill Guide, Silverback
P51-900-5006	5.2 Locking Drill Guide, Long, Silverback
P51-903-5006	5.2mm Compression Slot Drill Guide, Silverback
P99-150-0010	Hindfoot Distractor, 2.5 & 3.0 K-Wire
P99-000-AOLG	Mini-AO, Ratcheting Handle Streamline, Cannulated, Large
P99-000-AOMN	Mini-AO, Ratcheting Handle Streamline, Cannulated, Medium
P99-150-1343	Osteotome, Curved, Handled, 12mm
P99-150-1340	Osteotome, Curved, Handled, 3mm
P99-150-1341	Osteotome, Curved, Handled, 6mm
P99-150-1243	Osteotome, Straight, Handled, 12mm
P99-150-1241	Osteotome, Straight, Handled, 6mm
P51-905-5001	Over Drill Guide, Double Ended (3.5/4.2 & 4.5/5.2mm)
P99-100-3511	Over Drill, 3.5 x 110mm, Solid, AO
P99-100-4212	Over Drill, 4.2 x 120mm, Solid, AO
P99-100-4512	Over Drill, 4.5 x 120mm, Solid, AO
P99-100-5212	Over Drill, 5.2 x 120mm, Solid, AO
P50-900-1001	SILVERBACK™ Ankle Fusion, Case Base
P50-900-1002	SILVERBACK™ Ankle Fusion, Instrument Tray
P50-900-1006	SILVERBACK™ Upper Implant Tray
P99-000-316T	T-Handle, 3/16" Sq. Adaptor, Cannulated, Ratcheting
P51-911-4500	Tap, Double Lead, 4.5mm
P51-911-5200	Tap, Double Lead, 5.2mm
P51-910-5001	Threaded Bending Bar, Double Ended, Silverback
P50-900-3001	BABY GORILLA® Case Lid, Full Din
P99-150-0035	Bone Fenestration Chisel
P99-150-0135	Bone Fenestration Chisel, Curved
P99-100-2010	Bone Fenestration Perforator
P99-150-0055	Cartilage Removal Tool, Large
P51-902-1005	Centering Drill Guide, Long, 3.5mm, R3CON™
P51-902-1006	Centering Drill Guide, Long, 4.2mm, R3CON™
P51-902-5005	Centering Drill Guide, Long, 4.5mm, Silverback
P51-902-5006	Centering Drill Guide, Long, 5.2mm, Silverback
P99-150-0094	Curette, 20° Angled, 7mm

Not all products available for sale in all markets. To determine availability in your marketplace, please contact your local Paragon 28 representative or email info@paragon28.com.

SILVERBACK™ INSTRUMENTS

PART NUMBER	DESCRIPTION
P99-150-0096	Curette, Curved, 7mm
P99-150-0097	Curette, Ring, 20° Angled, 7mm
P99-150-0095	Curette, Ring, Straight, 7mm
P99-150-0136	Depth Gauge Plate Screw, 85mm Screw
P99-100-2416	Drill, 2.4 x 160mm, Solid, Measuring, Long, AO
P99-100-2816	Drill, 2.8 x 160mm, Solid, Measuring, Long, AO
P99-100-3116	Drill, 3.1 x 160mm, Solid, Measuring, Long, AO
P99-100-3616	Drill, 3.6 x 160mm, Solid, Measuring, Long, AO
P51-901-5135	Easy Guide, Long, Double-sided, Cone/Straight, 3.5mm
P51-901-5142	Easy Guide, Long, Double-sided, Cone/Straight, 4.2mm
P51-901-5145	Easy Guide, Long, Double-sided, Cone/Straight, 4.5mm
P51-901-5152	Easy Guide, Long, Double-sided, Cone/Straight, 5.2mm
P51-910-1002	Flat Plate Bender
P99-900-1005	Foot Plate, Plantigrade Guide, Radiolucent

Section 4:
**PHANTOM[®] SMALL BONE
INTRAMEDULLARY NAIL
SYSTEM**

Not all products available for sale in all markets. To determine availability in your marketplace, please contact your local Paragon 28 representative or email info@paragon28.com.



Phantom 3-Hole Nails

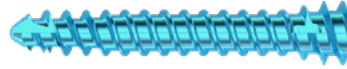

Lapidus Intermedullary Nail
Threaded Peg

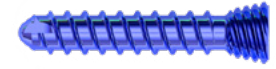

Lapidus Intramedullary Nail
Locking Screw

Phantom® 3-Hole Nails

PART NUMBER	DESCRIPTION
P30-R2-5538	Lapidus Nail, Ø5.5mm x 38mm, Right, 3 Hole
P30-R2-5540	Lapidus Nail, Ø5.5mm x 40mm, Right, 3 Hole
P30-R2-5542	Lapidus Nail, Ø5.5mm x 42mm, Right, 3 Hole
P30-R2-5544	Lapidus Nail, Ø5.5mm x 44mm, Right, 3 Hole
P30-R2-5546	Lapidus Nail, Ø5.5mm x 46mm, Right, 3 Hole
P30-R2-5548	Lapidus Nail, Ø5.5mm x 48mm, Right, 3 Hole
P30-R2-5550	Lapidus Nail, Ø5.5mm x 50mm, Right, 3 Hole
P30-R2-5552	Lapidus Nail, Ø5.5mm x 52mm, Right, 3 Hole
P30-R2-5554	Lapidus Nail, Ø5.5mm x 54mm, Right, 3 Hole
P30-R2-5556	Lapidus Nail, Ø5.5mm x 56mm, Right, 3 Hole
P30-R2-5558	Lapidus Nail, Ø5.5mm x 58mm, Right, 3 Hole
P30-R2-5560	Lapidus Nail, Ø5.5mm x 60mm, Right, 3 Hole
P30-L2-5538	Lapidus Nail, Ø5.5mm x 38mm, Left, 3 Hole
P30-L2-5540	Lapidus Nail, Ø5.5mm x 40mm, Left, 3 Hole
P30-L2-5542	Lapidus Nail, Ø5.5mm x 42mm, Left, 3 Hole
P30-L2-5544	Lapidus Nail, Ø5.5mm x 44mm, Left, 3 Hole
P30-L2-5546	Lapidus Nail, Ø5.5mm x 46mm, Left, 3 Hole
P30-L2-5548	Lapidus Nail, Ø5.5mm x 48mm, Left, 3 Hole
P30-L2-5550	Lapidus Nail, Ø5.5mm x 50mm, Left, 3 Hole
P30-L2-5552	Lapidus Nail, Ø5.5mm x 52mm, Left, 3 Hole
P30-L2-5554	Lapidus Nail, Ø5.5mm x 54mm, Left, 3 Hole
P30-L2-5556	Lapidus Nail, Ø5.5mm x 56mm, Left, 3 Hole
P30-L2-5558	Lapidus Nail, Ø5.5mm x 58mm, Left, 3 Hole
P30-L2-5560	Lapidus Nail, Ø5.5mm x 60mm, Left, 3 Hole

Not all products available for sale in all markets. To determine availability in your marketplace, please contact your local Paragon 28 representative or email info@paragon28.com.



Phantom 4-Hole Nails

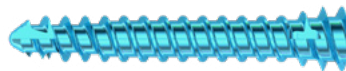

Lapidus Intermedullary Nail
Threaded Peg

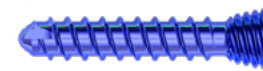

Lapidus Intramedullary Nail
Locking Screw

Phantom® 4-Hole Nails

PART NUMBER	DESCRIPTION
P30-R1-5538	Lapidus Nail, Ø5.5mm x 38mm, Right
P30-R1-5540	Lapidus Nail, Ø5.5mm x 40mm, Right
P30-R1-5542	Lapidus Nail, Ø5.5mm x 42mm, Right
P30-R1-5544	Lapidus Nail, Ø5.5mm x 44mm, Right
P30-R1-5546	Lapidus Nail, Ø5.5mm x 46mm, Right
P30-R1-5548	Lapidus Nail, Ø5.5mm x 48mm, Right
P30-R1-5550	Lapidus Nail, Ø5.5mm x 50mm, Right
P30-R1-5552	Lapidus Nail, Ø5.5mm x 52mm, Right
P30-R1-5554	Lapidus Nail, Ø5.5mm x 54mm, Right
P30-R1-5556	Lapidus Nail, Ø5.5mm x 56mm, Right
P30-R1-5558	Lapidus Nail, Ø5.5mm x 58mm, Right
P30-R1-5560	Lapidus Nail, Ø5.5mm x 60mm, Right
P30-L1-5538	Lapidus Nail, Ø5.5mm x 38mm, Left
P30-L1-5540	Lapidus Nail, Ø5.5mm x 40mm, Left
P30-L1-5542	Lapidus Nail, Ø5.5mm x 42mm, Left
P30-L1-5544	Lapidus Nail, Ø5.5mm x 44mm, Left
P30-L1-5546	Lapidus Nail, Ø5.5mm x 46mm, Left
P30-L1-5548	Lapidus Nail, Ø5.5mm x 48mm, Left
P30-L1-5550	Lapidus Nail, Ø5.5mm x 50mm, Left
P30-L1-5552	Lapidus Nail, Ø5.5mm x 52mm, Left
P30-L1-5554	Lapidus Nail, Ø5.5mm x 54mm, Left
P30-L1-5556	Lapidus Nail, Ø5.5mm x 56mm, Left
P30-L1-5558	Lapidus Nail, Ø5.5mm x 58mm, Left
P30-L1-5560	Lapidus Nail, Ø5.5mm x 60mm, Left

Not all products available for sale in all markets. To determine availability in your marketplace, please contact your local Paragon 28 representative or email info@paragon28.com.

Phantom® Instruments

PART NUMBER	DESCRIPTION
P30-000-CASE	Lapidus Nail, Case Base
P30-000-CASL	Lapidus Nail, Case Lid
P30-000-INST	Lapidus Nail, Instrument Tray
P30-000-LNCL	Lapidus Nail, Nail Caddy, Lid
P30-000-LNCB	Lapidus Nail, Nail Caddy, Base
P30-000-LSCL	Lapidus Nail, Screw Caddy, Lid
P30-000-LSCB	Lapidus Nail, Screw Caddy, Base
P30-000-KWT1	Lapidus Nail, 1.6mm K-wire Tube
P30-000-KWT2	Lapidus Nail, 2.0mm K-wire Tube
P30-000-KWT3	Lapidus Nail, 2.3mm K-wire Tube
P30-000-KWT4	Lapidus Nail, Sphere Wire Tube
P30-000-KWC1	Lapidus Nail, Tube Cap, Standard
P30-000-KWC2	Lapidus Nail, Tube Cap, Sphere Wire
P30-P1-3510	Lapidus Nail, Threaded Peg, Ø3.5mm x 10mm
P30-P1-3512	Lapidus Nail, Threaded Peg, Ø3.5mm x 12mm
P30-P1-3514	Lapidus Nail, Threaded Peg, Ø3.5mm x 14mm
P30-P1-3516	Lapidus Nail, Threaded Peg, Ø3.5mm x 16mm
P30-P1-3518	Lapidus Nail, Threaded Peg, Ø3.5mm x 18mm
P30-P1-3520	Lapidus Nail, Threaded Peg, Ø3.5mm x 20mm
P30-P1-3522	Lapidus Nail, Threaded Peg, Ø3.5mm x 22mm
P30-P1-3524	Lapidus Nail, Threaded Peg, Ø3.5mm x 24mm
P30-P1-3526	Lapidus Nail, Threaded Peg, Ø3.5mm x 26mm
P30-P1-3528	Lapidus Nail, Threaded Peg, Ø3.5mm x 28mm
P30-P1-3530	Lapidus Nail, Threaded Peg, Ø3.5mm x 30mm
P30-P1-3532	Lapidus Nail, Threaded Peg, Ø3.5mm x 32mm
P30-P1-3534	Lapidus Nail, Threaded Peg, Ø3.5mm x 34mm
P30-P1-3536	Lapidus Nail, Threaded Peg, Ø3.5mm x 36mm
P30-P1-3538	Lapidus Nail, Threaded Peg, Ø3.5mm x 38mm
P30-P1-3540	Lapidus Nail, Threaded Peg, Ø3.5mm x 40mm
P30-P1-3542	Lapidus Nail, Threaded Peg, Ø3.5mm x 42mm
P30-P1-3544	Lapidus Nail, Threaded Peg, Ø3.5mm x 44mm
P30-P1-3546	Lapidus Nail, Threaded Peg, Ø3.5mm x 46mm
P30-S1-3510	Lapidus Nail, Locking Screw, Ø3.5mm x 10mm
P30-S1-3512	Lapidus Nail, Locking Screw, Ø3.5mm x 12mm
P30-S1-3514	Lapidus Nail, Locking Screw, Ø3.5mm x 14mm
P30-S1-3516	Lapidus Nail, Locking Screw, Ø3.5mm x 16mm
P30-S1-3518	Lapidus Nail, Locking Screw, Ø3.5mm x 18mm
P30-S1-3520	Lapidus Nail, Locking Screw, Ø3.5mm x 20mm
P30-S1-3522	Lapidus Nail, Locking Screw, Ø3.5mm x 22mm
P30-S1-3524	Lapidus Nail, Locking Screw, Ø3.5mm x 24mm
P30-S1-3526	Lapidus Nail, Locking Screw, Ø3.5mm x 26mm

Not all products available for sale in all markets. To determine availability in your marketplace, please contact your local Paragon 28 representative or email info@paragon28.com.

Phantom® Instruments

PART NUMBER	DESCRIPTION
P99-192-1615	Ø1.60mm x 15cm Kirschner Wire, 316 LVM
P99-192-2015	Ø2.00mm x 15cm Kirschner Wire, 316 LVM
P99-000-AOMN	Mini Axial Ratchet Handle, AO Pull Adapter, Cannulated
P30-100-TORQ	Torque Indicating Driver, T10
P99-150-0019	Lapidus Nipper
P99-100-2009	Refresh Drill, Ø2.0mm x 85mm
P99-150-0035	Bone Fenestration Chisel
P99-150-0015	Medium Hintermann Distractor
P30-900-100R	Lapidus Nail, Outrigger, Assembly, Right
P30-900-100L	Lapidus Nail, Outrigger, Assembly, Left
P30-900-027R	Lapidus Nail, Outrigger Slider, Right, 38mm/40mm
P30-900-031R	Lapidus Nail, Outrigger Slider, Right, 42mm/44mm
P30-900-035R	Lapidus Nail, Outrigger Slider, Right, 46mm/48mm
P30-900-040R	Lapidus Nail, Outrigger Slider, Right, 50mm/52mm
P30-900-043R	Lapidus Nail, Outrigger Slider, Right, 54mm/56mm
P30-900-047R	Lapidus Nail, Outrigger Slider, Right, 58mm/60mm
P30-900-027L	Lapidus Nail, Outrigger Slider, Left, 38mm/40mm
P30-900-031L	Lapidus Nail, Outrigger Slider, Left, 42mm/44mm
P30-900-035L	Lapidus Nail, Outrigger Slider, Left, 46mm/48mm
P30-900-040L	Lapidus Nail, Outrigger Slider, Left, 50mm/52mm
P30-900-043L	Lapidus Nail, Outrigger Slider, Left, 54mm/56mm
P30-900-047L	Lapidus Nail, Outrigger Slider, Left, 58mm/60mm
P30-900-5002	Lapidus Nail, Thumbscrew, Assembly
P30-900-5001	Lapidus Nail, Slaphammer, Assembly
P30-901-5175	Lapidus Nail, Screw Guide
P30-902-2987	Lapidus Nail, Drill/Pin Guide
P30-903-2812	Lapidus Nail, Obturator
P30-905-2300	Lapidus Nail, Nail Positioning Guide
P30-906-2989	Lapidus Nail, Locking Guide
P30-100-5309	Lapidus Nail, Tissue Protector
P30-100-6810	Lapidus Nail, Claw Guide, Assembly
P30-100-5493	Lapidus Nail, Claw Guide Sleeve Insert
P30-196-2323	Lapidus Nail, K-wire, Long Trocar Tip, Ø2.3mm x 230mm
P30-196-2720	Lapidus Nail, K-Wire, Ø2.75mm x 200mm
P30-110-5517	Lapidus Nail, Cannulated Drill, Ø5.5mm x 170mm
P30-952-2720	Lapidus Nail, Ø2.75mm K-Wire Depth Gauge
P30-952-3000	Lapidus Nail, Nail Depth Gauge
P99-150-0086	Depth Gauge, 60mm
P99-251-1607	K-wire, Olive, Threaded, Ø1.8mm x 72mm
P99-191-LT10	HX10 x 138mm Solid Driver

Section 5:
**LAPIDUS CUT GUIDE
AND MINIMALLY
INVASIVE SYSTEMS**

Not all products available for sale in all markets. To determine availability in your marketplace, please contact your local Paragon 28 representative or email info@paragon28.com.



LAPIDUS CUT GUIDES

PART NUMBER	DESCRIPTION
P30-CAD-BASE	Caddy PolyPro Base
P50-900-49GL	Paragon 28 Caddy Lid 4x9
P30-942-G101	Metatarsal Alignment Guide
P30-940-C101	Cleanup Guide
P30-940-R104	Metatarsal Cut Guide, Right, 4°
P30-940-L104	Metatarsal Cut Guide, Left, 4°
P30-943-R100	Met-Cuneiform Guide, Right, 0°
P30-943-L100	Met-Cuneiform Guide, Left, 0°
P30-942-R108	Met-Cuneiform Guide, Right, 8°
P30-942-L108	Met-Cuneiform Guide, Left, 8°
P30-942-R110	Met-Cuneiform Guide, Right, 10°
P30-942-L110	Met-Cuneiform Guide, Left, 10°
P30-942-R112	Met-Cuneiform Guide, Right, 12°
P30-942-L112	Met-Cuneiform Guide, Left, 12°
P30-942-R114	Met-Cuneiform Guide, Right, 14°
P30-942-L114	Met-Cuneiform Guide, Left, 14°
P30-942-R116	Met-Cuneiform Guide, Right, 16°
P30-942-L116	Met-Cuneiform Guide, Left, 16°
P30-942-R118	Met-Cuneiform Guide, Right, 18°
P30-942-L118	Met-Cuneiform Guide, Left, 18°
P30-942-R120	Met-Cuneiform Guide, Right, 20°
P30-942-L120	Met-Cuneiform Guide, Left, 20°
P99-192-1610	K-Wire, Single Ended Trocar Tip, Smooth 1.6 X 100mm
P30-192-1615	1.6, Double-Blunt K-wire, 150 mm
P99-151-P30M	Sawblade 9x31x.051mm MicroAire Con.
P99-151-P30S	Sawblade 9x31x.051mm Stryker Con.

Not all products available for sale in all markets. To determine availability in your marketplace, please contact your local Paragon 28 representative or email info@paragon28.com.



3.0 mm Shannon-
Style Bone Burr



MIS Burr Guide

LAPIDUS MINIMALLY INVASIVE GUIDES

PART NUMBER	DESCRIPTION
P30-000-MISB	MIS Lapidus, Caddy Base
P30-MIS-2819	MIS Lapidus, Burr Guide
P30-MIS-3050	MIS Lapidus, Burr Guide, Paddle
P30-MIS-6815	MIS Lapidus, Flute Cleaner
P50-900-49GL	Caddy Lid (Half Module)
P99-105-3090	Shannon-Style Bone Burr, 3.0mm
P99-150-0091	Mini Curette, Large, 20°
P99-150-0340	Osteotome, Curved w/ Handle, 6mm
P99-192-1610	K-Wire, Single Ended Trocar Tip, SMOOTH, 1.6 x 100mm
P99-250-1608	Olive Wire, SMOOTH, 1.6 x 80mm, Tower Wire, Standard

Section 6:

PHANTOM[®] TTC/TC NAIL AND ACTIVCORE[™]

Not all products available for sale in all markets. To determine availability in your marketplace, please contact your local Paragon 28 representative or email info@paragon28.com.



Ø5.0 mm
Threaded Peg



Ø7.2 mm
Threaded Peg

Phantom ActivCore Nails
(175, 200, 250, and 300 mm)

PHANTOM® ACTIVCORE™ IMPLANTS

PART NUMBER	DESCRIPTION
P31-955-1800-S	Phantom Hindfoot Ball Tipped Guide Rod, 3.0 x 800mm
P99-106-6005-S	Barrel Burr, 6.0 x 55mm OAL, J-Notch
P99-107-6005-S	Oval Burr, 6.0 x 55mm OAL, J-Notch
P31-102-1750-S	Phantom ActivCore Nail, 10.0 X 175mm
P31-102-2000-S	Phantom ActivCore Nail, 10.0 X 200mm
P31-102-2500-S	Phantom ActivCore Nail, 10.0 X 250mm
P31-102-3000-S	Phantom ActivCore Nail, 10.0 X 300mm
P31-115-1750-S	Phantom ActivCore Nail, 11.5 X 175mm
P31-115-2000-S	Phantom ActivCore Nail, 11.5 X 200mm
P31-115-2500-S	Phantom ActivCore Nail, 11.5 X 250mm
P31-115-3000-S	Phantom ActivCore Nail, 11.5 X 300mm
P31-130-1750-S	Phantom ActivCore Nail, 13.0 X 175mm
P31-130-2000-S	Phantom ActivCore Nail, 13.0 X 200mm
P31-130-2500-S	Phantom ActivCore Nail, 13.0 X 250mm

Not all products available for sale in all markets. To determine availability in your marketplace, please contact your local Paragon 28 representative or email info@paragon28.com.

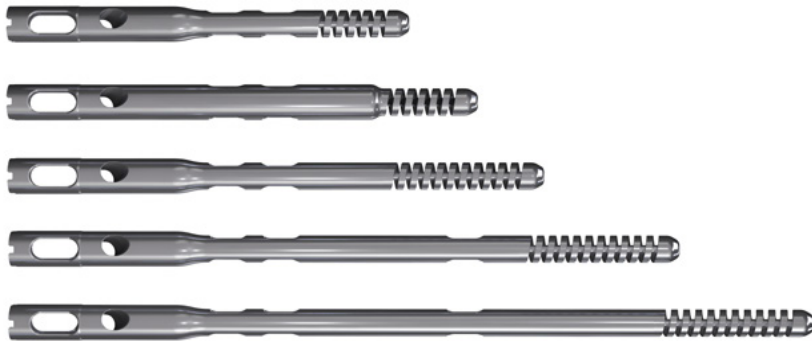

Phantom TTC/TC Nails
(150, 175, 200, 250, and 300 mm)



Ø5.0 mm
Threaded Peg



Ø7.2 mm
Threaded Peg

PHANTOM® TTC/TC NAIL IMPLANTS

PART NUMBER	DESCRIPTION
P31-955-1800-S	Phantom Hindfoot Ball Tipped Guide Rod, 3.0 x 800mm
P99-106-6005-S	Barrel Burr, Ø6.0, 55mm OAL, J-Notch
P99-107-6005-S	Oval Burr, Ø6.0, 55mm OAL, J-Notch
P31-400-1500-S	Phantom TC Nail, 10.0 X 150mm
P31-400-2000-S	Phantom TC Nail, 10.0 X 200mm
P31-400-2500-S	Phantom TC Nail, 10.0 X 250mm
P31-400-3000-S	Phantom TC Nail, 10.0 X 300mm
P31-415-1500-S	Phantom TC Nail, 11.5 X 150mm
P31-415-2000-S	Phantom TC Nail, 11.5 X 200mm
P31-415-2500-S	Phantom TC Nail, 11.5 X 250mm
P31-415-3000-S	Phantom TC Nail, 11.5 X 300mm
P31-430-1500-S	Phantom TC Nail, 13.0 X 150mm
P31-430-1750-S	Phantom TC Nail, 13.0 X 175mm
P31-430-2000-S	Phantom TC Nail, 13.0 X 200mm
P31-430-2500-S	Phantom TC Nail, 13.0 X 250mm

Not all products available for sale in all markets. To determine availability in your marketplace, please contact your local Paragon 28 representative or email info@paragon28.com.

PHANTOM® INSTRUMENTS

PART NUMBER	DESCRIPTION
P99-150-0035	Bone Fenestration Chisel
P99-150-0135	Bone Fenestration Chisel, Curved
P99-100-2010	Bone Fenestration Perforator
P99-150-0055	Cartilage Removal Tool, Large
P99-150-0094	Curette, 20° Angled, 7mm
P99-150-0096	Curette, Curved, 7mm
P99-150-0097	Curette, Ring, 20° Angled, 7mm
P99-150-0095	Curette, Ring, Straight, 7mm
P99-150-1343	Osteotome, Curved, Handled, 12mm
P99-150-1340	Osteotome, Curved, Handled, 3mm
P99-150-1341	Osteotome, Curved, Handled, 6mm
P99-150-1243	Osteotome, Straight, Handled, 12mm
P99-150-1241	Osteotome, Straight, Handled, 6mm
P31-940-0002	Implant Sizer
P99-150-0001	Screw Forceps
P99-192-2020	K-Wire, Single Ended Trocar Tip, SMOOTH, 2.0 x 200mm
P99-192-2330	K-Wire, Single Ended Trocar Tip, SMOOTH, 2.3 x 300mm
P31-941-0200	Wire Tube, 2.0 x 200mm
P31-941-0320	Wire Tube, 2.3 x 300mm
P31-941-0340	Wire Tube, 3.0 x 320mm
P31-941-0000	Wire Tube, Cap
P31-951-3032	PRECISION® Guide Drill Pin, 3.0 X 320mm
P31-951-0199	PRECISION® Guide Sphere Wire
P31-951-0101	PRECISION® Guide Arm
P31-951-0102	PRECISION® Guide Tube
P31-951-0103	PRECISION® Guide Alignment Fin
P31-951-1000	PRECISION® Parallel Offset Guide
P20-930-7000	Tissue Protector
P99-110-7019	7.0 x 20cm Drill
P31-956-0001	Tissue Protector
P99-110-0813	Stepped Reamer
P31-901-LID	Phantom Hindfoot TTC/TC Nail, Case Lid
P31-901-BASE	Phantom Hindfoot TTC/TC Nail, Case Base, Case 1 of 3
P31-901-TRY1	Phantom Hindfoot TTC/TC Nail, Tray 1, Case 1 of 3
P31-901-TRY2	Phantom Hindfoot TTC/TC Nail, Tray 2, Case 1 of 3
P31-955-1550	Phantom Hindfoot Ball Tipped Guide Rod, 3.0 x 550mm
P31-955-0080	Phantom Hindfoot Reamer, 8.0mm
P31-955-0085	Phantom Hindfoot Reamer, 8.5mm
P31-955-0090	Phantom Hindfoot Reamer, 9.0mm
P31-955-0095	Phantom Hindfoot Reamer, 9.5mm

Not all products available for sale in all markets. To determine availability in your marketplace, please contact your local Paragon 28 representative or email info@paragon28.com.

PHANTOM® INSTRUMENTS

PART NUMBER	DESCRIPTION
P31-955-0100	Phantom Hindfoot Reamer, 10.0mm
P31-955-0105	Phantom Hindfoot Reamer, 10.5mm
P31-955-0110	Phantom Hindfoot Reamer, 11.0mm
P31-955-0115	Phantom Hindfoot Reamer, 11.5mm
P31-955-0120	Phantom Hindfoot Reamer, 12.0mm
P31-955-0125	Phantom Hindfoot Reamer, 12.5mm
P31-955-0130	Phantom Hindfoot Reamer, 13.0mm
P31-955-0135	Phantom Hindfoot Reamer, 13.5mm
P31-955-0140	Phantom Hindfoot Reamer, 14.0mm
P31-954-0345	Phantom Hindfoot Flexible Reamer Shaft, 345mm
P31-954-0417	Phantom Hindfoot Flexible Reamer Shaft, 417mm
P99-150-0010	Hindfoot Distractor, 2.5 & 3.0 K-Wire
P31-950-0000	Ghost Outrigger Base
P31-950-0002	Ghost Outrigger Mounting Bolt
P31-950-0003	Ghost Outrigger Tibial Drill Guide, 5mm
P31-950-0004	Ghost Outrigger Calc Drill Guide, 7.2mm
P31-950-0005	Ghost Outrigger Tibial Screw Guide, 5mm
P31-950-0006	Ghost Outrigger Calc K-Wire Guide, 7.2mm
P31-950-0007	Ghost Outrigger Calc Screw Guide, 7.2mm, Active
P31-950-0008	Ghost Outrigger Subtalar Drill Guide, 7.2mm
P31-950-0009	Ghost Outrigger Subtalar Screw Guide, 7.2mm
P31-950-0057	Ghost Outrigger Calc Screw Guide, 7.2mm
P31-950-0033	Ghost Outrigger Guide, Proximal Arm
P31-950-0050	Ghost Outrigger Guide, Subtalar Arm
P31-950-1000	Ghost Outrigger Guide, Homerun Screw Arm
P31-950-1001-14	Ghost Outrigger Homerun Guidewire Sleeve, 4.5mm
P31-950-1001-16	Ghost Outrigger Homerun Guidewire Sleeve, 5.5mm
P31-950-1001-23	Ghost Outrigger Homerun Guidewire Sleeve, 7.0mm
P31-901-LID	Phantom Hindfoot TTC/TC Nail, Case Lid
P31-902-BASE	Phantom Hindfoot TTC/TC Nail, Case Base, Case 2 of 3
P31-902-TRY1	Phantom Hindfoot TTC/TC Nail, Tray 1, Case 2 of 3
P31-902-TRY2	Phantom Hindfoot TTC/TC Nail, Tray 2, Case 2 of 3
P31-902-RMCD	Phantom Hindfoot TTC/TC Nail, Reamer Caddy, Case 2 of 3
P31-950-9000	Bolt Driver Attachment, 8mm Hex, Phantom Hindfoot
P99-150-2001	ThorHammer
P99-150-2002	Slap Hammer
P31-958-0001	Explant Attachment, Phantom Hindfoot
P99-110-4630	Drill, 4.6 x 300mm, Cannulated, 3/16" Sq. Connection
P99-100-4630	Drill, 4.6 X 300mm, Solid, Trocar Tip, 3/16" Sq. Connection
P99-100-3825	Drill, 3.8 X 250mm Drill, Solid, Trocar Tip, 3/16" Sq. Connection

Not all products available for sale in all markets. To determine availability in your marketplace, please contact your local Paragon 28 representative or email info@paragon28.com.



Ø5.0 mm
Threaded Peg



Ø7.2 mm
Threaded Peg

PHANTOM® INSTRUMENTS AND PEGS

PART NUMBER	DESCRIPTION
P31-957-0001	Phantom Hindfoot Depth Gauge, Solid
P31-957-0002	Phantom Hindfoot Depth Gauge, Cannulated
P99-191-TX20-16	Screw Driver Attachment, Solid, 3/16" Sq. Connection, TX-20 x 160mm
P99-191-TX20-09	Screw Driver Attachment, Solid, 3/16" Sq. Connection, TX-20 x 90mm
P99-191-TX30-16	Screw Driver Attachment, Solid, 3/16" Sq. Connection, TX-30 x 160mm
P31-190-TX30-09	Phantom Screw Driver Attachment, Cannulated, 3/16" Sq. Connection, TX-30 x 85mm
P99-000-316A	3/16" Sq. Adaptor
P99-000-316M	Axial Ratcheting Handle, MEDIUM, 3/16" Sq. Adaptor
P99-000-316T	T-Handle, 3/16" Sq. Adaptor, Cannulated, Ratcheting
P31-772-045F	Phantom Hindfoot Nail, Threaded Peg, 7.2mm x 45mm
P31-772-050F	Phantom Hindfoot Nail, Threaded Peg, 7.2mm x 50mm
P31-772-055F	Phantom Hindfoot Nail, Threaded Peg, 7.2mm x 55mm
P31-772-060F	Phantom Hindfoot Nail, Threaded Peg, 7.2mm x 60mm
P31-772-065F	Phantom Hindfoot Nail, Threaded Peg, 7.2mm x 65mm
P31-772-070F	Phantom Hindfoot Nail, Threaded Peg, 7.2mm x 70mm
P31-772-075F	Phantom Hindfoot Nail, Threaded Peg, 7.2mm x 75mm
P31-772-080F	Phantom Hindfoot Nail, Threaded Peg, 7.2mm x 80mm
P31-772-085F	Phantom Hindfoot Nail, Threaded Peg, 7.2mm x 85mm
P31-772-090F	Phantom Hindfoot Nail, Threaded Peg, 7.2mm x 90mm
P31-772-095F	Phantom Hindfoot Nail, Threaded Peg, 7.2mm x 95mm
P31-772-100F	Phantom Hindfoot Nail, Threaded Peg, 7.2mm x 100mm
P31-772-105F	Phantom Hindfoot Nail, Threaded Peg, 7.2mm x 105mm
P31-772-110F	Phantom Hindfoot Nail, Threaded Peg, 7.2mm x 110mm
P31-772-115F	Phantom Hindfoot Nail, Threaded Peg, 7.2mm x 115mm
P31-772-120F	Phantom Hindfoot Nail, Threaded Peg, 7.2mm x 120mm
P32-450-020F	Phantom Hindfoot Nail, Threaded Peg, 5.0mm x 20mm
P32-450-022F	Phantom Hindfoot Nail, Threaded Peg, 5.0mm x 22mm
P32-450-024F	Phantom Hindfoot Nail, Threaded Peg, 5.0mm x 24mm
P32-450-026F	Phantom Hindfoot Nail, Threaded Peg, 5.0mm x 26mm
P32-450-028F	Phantom Hindfoot Nail, Threaded Peg, 5.0mm x 28mm

Not all products available for sale in all markets. To determine availability in your marketplace, please contact your local Paragon 28 representative or email info@paragon28.com.

PHANTOM® INSTRUMENTS AND PEGS

PART NUMBER	DESCRIPTION
P32-450-030F	Phantom Hindfoot Nail, Threaded Peg, 5.0mm x 30mm
P32-450-032F	Phantom Hindfoot Nail, Threaded Peg, 5.0mm x 32mm
P32-450-034F	Phantom Hindfoot Nail, Threaded Peg, 5.0mm x 34mm
P32-450-036F	Phantom Hindfoot Nail, Threaded Peg, 5.0mm x 36mm
P32-450-038F	Phantom Hindfoot Nail, Threaded Peg, 5.0mm x 38mm
P32-450-040F	Phantom Hindfoot Nail, Threaded Peg, 5.0mm x 40mm
P32-450-042F	Phantom Hindfoot Nail, Threaded Peg, 5.0mm x 42mm
P32-450-044F	Phantom Hindfoot Nail, Threaded Peg, 5.0mm x 44mm
P32-450-046F	Phantom Hindfoot Nail, Threaded Peg, 5.0mm x 46mm
P32-450-048F	Phantom Hindfoot Nail, Threaded Peg, 5.0mm x 48mm
P32-450-050F	Phantom Hindfoot Nail, Threaded Peg, 5.0mm x 50mm
P32-450-052F	Phantom Hindfoot Nail, Threaded Peg, 5.0mm x 52mm
P32-450-054F	Phantom Hindfoot Nail, Threaded Peg, 5.0mm x 54mm
P32-450-056F	Phantom Hindfoot Nail, Threaded Peg, 5.0mm x 56mm
P32-450-058F	Phantom Hindfoot Nail, Threaded Peg, 5.0mm x 58mm
P32-450-060F	Phantom Hindfoot Nail, Threaded Peg, 5.0mm x 60mm
P32-450-062F	Phantom Hindfoot Nail, Threaded Peg, 5.0mm x 62mm
P32-450-064F	Phantom Hindfoot Nail, Threaded Peg, 5.0mm x 64mm
P32-450-066F	Phantom Hindfoot Nail, Threaded Peg, 5.0mm x 66mm
P32-450-068F	Phantom Hindfoot Nail, Threaded Peg, 5.0mm x 68mm
P32-450-070F	Phantom Hindfoot Nail, Threaded Peg, 5.0mm x 70mm
P31-101-0000-03	Phantom Hindfoot Nail, Internal Compression Screw
P31-102-0001	Phantom Hindfoot Nail, Shouldered End Cap, Short
P31-102-0005	Phantom Hindfoot Nail, Shouldered End Cap, Long
P31-111-0000-03	Phantom Hindfoot Nail, Compression End Cap, Short
P31-111-0000-07	Phantom Hindfoot Nail, Compression End Cap, Long
P31-901-LID	Phantom Hindfoot TTC/TC Nail, Case Lid
P31-903-BASE	Phantom Hindfoot TTC/TC Nail, Case Base, Case 3 of 3
P31-903-TRY1	Phantom Hindfoot TTC/TC Nail, Tray 1, Case 3 of 3
P31-903-TRY2	Phantom Hindfoot TTC/TC Nail, Tray 2, Case 3 of 3
P31-903-C1LD	Phantom Hindfoot TTC/TC Nail, Caddy 1 Lid, Case 3 of 3
P31-903-C1BS	Phantom Hindfoot TTC/TC Nail, Caddy 1 Base, Case 3 of 3
P31-903-CLD2	Phantom Hindfoot TTC/TC Nail, Caddy 2 Lid, Case 3 of 3
P31-903-CBS2	Phantom Hindfoot TTC/TC Nail, Caddy 2 Base, Case 3 of 3

Section 7:
PROMO™

Not all products available for sale in all markets. To determine availability in your marketplace, please contact your local Paragon 28 representative or email info@paragon28.com.

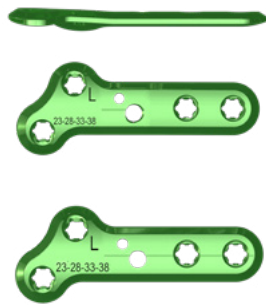

PROMO™ Straight Plates

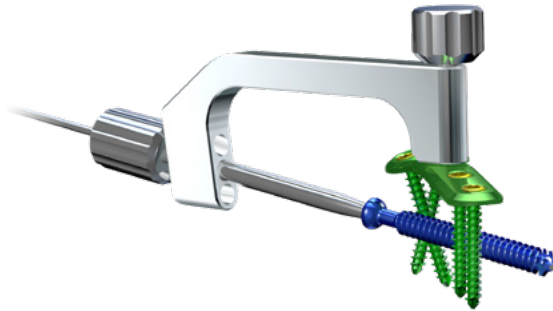

PROMO™ Precision Guide

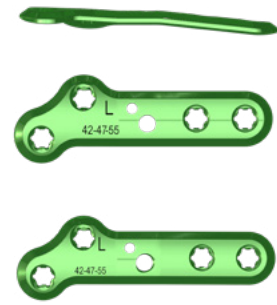

PROMO™ Angled Plates

PROMO™ PLATES

PART NUMBER	DESCRIPTION
P50-900-3109-1	Caddy, PROMO, Plates & Instruments
P50-900-3110-1	Caddy, Lid, PROMO, Plates & Instruments
P51-908-R011	PROMO Positioning Jig Right
P51-908-L011	PROMO Positioning Jig Left
P51-908-0012	PROMO Cut Guide
P51-908-0013	PROMO Rotation Jig
P51-908-0004	Foot Plate K-Wire Guide
P51-908-0010	PROMO Precision Guide, 6 Barrel
P51-908-0007	Foot Plate K-Wire Guide Retainer
P51-950-0001	Precision Guide Set Screw
P51-950-0010	Guidewire Sleeve 1.0 mm
P51-950-0012	Guidewire Sleeve 1.2 mm
P53-014-L002	PROMO Plate Left, Straight, Short
P53-014-L003	PROMO Plate Left, Straight, Long
P53-014-L021	PROMO Plate, Left, Angled, Short
P53-014-L022	PROMO Plate, Left, Angled, Long
P53-014-R002	PROMO Plate Right, Straight, Short
P53-014-R003	PROMO Plate Right, Straight, Long
P53-014-R021	PROMO Plate,Right, Angled, Short
P53-014-R022	PROMO Plate, Right, Angled, Long
P53-001-1010	Akin Plate, Straight, 10 mm
P53-001-1C10	Akin Plate, w/Compression, 10 mm
P53-001-2010	Akin Plate, Medial, Anatomic, 10 mm
P99-200-1307	1.3, smooth olive, 7 cm
P99-201-1307	1.3, threaded olive, 7 cm
P99-250-1608	1.6, smooth olive, 8 cm
P99-192-1615	K-wire, Single Ended Trocar Tip, SMOOTH, 1.6 x 150 mm
P99-192-1610	K-wire, Single Ended Trocar Tip, SMOOTH, 1.6 x 100 mm

JUMP TO PROMO PLATES
STERILE PACKAGED PRODUCT

Not all products available for sale in all markets. To determine availability in your marketplace, please contact your local Paragon 28 representative or email info@paragon28.com.



Locking 2.0 and 2.5 Baby Gorilla Screws

Non-Locking 2.0 and 2.5 Baby Gorilla Screws

15* Variable Axis

PROMO™ SCREWS

PART NUMBER	DESCRIPTION
P50-900-3103-1	Promo™ Mini-Monster® Instrument Caddy Base
P50-900-3107-1	Promo™ Screw Caddy Base
P50-900-3108-1	Promo™ Screw Caddy Lid
P20-910-2000	Countersink, 2.0 Headed
P20-915-2000	Countersink, 2.0 Headless
P20-910-2500	Countersink, 2.5/2.7 Headed
P20-915-2500	Countersink, 2.5 Headless
P20-920-2500	Tap, 2.5/2.7, Cannulated
P20-951-2040	Depth Gauge (2.0 - 4.0 mm)
P99-110-1712	Drill, 1.7 x 120mm, Cannulated, AO
P99-192-0915	K-wire, Single Ended Trocar Tip, SMOOTH, 0.9 x 150 mm
P99-292-0915	K-wire, Double Ended Trocar Tip, SMOOTH, 0.9 x 150 mm
P20-941-2025	Drill Guide, 2.0/2.5
P99-191-TS07	Screw Driver Attachment, Solid, AO, TX-7
P99-191-SL07	Mini-Screw Gripper
P99-190-TX06	Modified Tx 6 Screw Driver Attachment, Cannulated
P99-191-TX06	Screw Driver Attachment, Solid, AO, HX-6
P99-190-SL06	Holding Sleeve, HX-6
P50-153-WM00	Baby Gorilla, Washer
P20-020-DW00	Washer, 2.0 Headed
P20-025-DW00	Washer, 2.5 Headed
P50-053-2008	BG Locking Screw, 2.0 x 08mm
P50-053-2010	BG Locking Screw, 2.0 x 10mm
P50-053-2012	BG Locking Screw, 2.0 x 12mm
P50-053-2014	BG Locking Screw, 2.0 x 14mm
P50-053-2016	BG Locking Screw, 2.0 x 16mm
P50-053-2018	BG Locking Screw, 2.0 x 18mm
P50-053-2020	BG Locking Screw, 2.0 x 20mm
P50-053-2022	BG Locking Screw, 2.0 x 22mm
P50-053-2024	BG Locking Screw, 2.0 x 24mm

Not all products available for sale in all markets. To determine availability in your marketplace, please contact your local Paragon 28 representative or email info@paragon28.com.

PROMO™ SCREWS

PART NUMBER	DESCRIPTION
P50-053-2026	BG Locking Screw, 2.0 x 26mm
P50-053-2028	BG Locking Screw, 2.0 x 28mm
P50-053-2030	BG Locking Screw, 2.0 x 30mm
P50-053-2032	BG Locking Screw, 2.0 x 32mm
P50-053-2034	BG Locking Screw, 2.0 x 34mm
P50-053-2036	BG Locking Screw, 2.0 x 36mm
P50-153-2008	BG Non-Locking Screw 2.0 x 08mm
P50-153-2010	BG Non-Locking Screw 2.0 x 10mm
P50-153-2012	BG Non-Locking Screw 2.0 x 12mm
P50-153-2014	BG Non-Locking Screw 2.0 x 14mm
P50-153-2016	BG Non-Locking Screw 2.0 x 16mm
P50-153-2018	BG Non-Locking Screw 2.0 x 18mm
P50-153-2020	BG Non-Locking Screw 2.0 x 20mm
P50-153-2022	BG Non-Locking Screw 2.0 x 22mm
P50-153-2024	BG Non-Locking Screw 2.0 x 24mm
P50-153-2026	BG Non-Locking Screw 2.0 x 26mm
P50-153-2028	BG Non-Locking Screw 2.0 x 28mm
P50-153-2030	BG Non-Locking Screw 2.0 x 30mm
P50-153-2032	BG Non-Locking Screw 2.0 x 32mm
P50-153-2034	BG Non-Locking Screw 2.0 x 34mm
P50-153-2036	BG Non-Locking Screw 2.0 x 36mm
P50-053-2508	BG Locking Screw, 2.5 x 08mm
P50-053-2510	BG Locking Screw, 2.5 x 10mm
P50-053-2512	BG Locking Screw, 2.5 x 12mm
P50-053-2514	BG Locking Screw, 2.5 x 14mm
P50-053-2516	BG Locking Screw, 2.5 x 16mm
P50-053-2518	BG Locking Screw, 2.5 x 18mm
P50-053-2520	BG Locking Screw, 2.5 x 20mm
P50-053-2522	BG Locking Screw, 2.5 x 22mm
P50-053-2524	BG Locking Screw, 2.5 x 24mm
P50-053-2526	BG Locking Screw, 2.5 x 26mm
P50-053-2528	BG Locking Screw, 2.5 x 28mm
P50-053-2530	BG Locking Screw, 2.5 x 30mm
P50-053-2532	BG Locking Screw, 2.5 x 32mm
P50-053-2534	BG Locking Screw, 2.5 x 34mm
P50-053-2536	BG Locking Screw, 2.5 x 36mm
P50-153-2508	BG Non-Locking Screw 2.5 x 08mm
P50-153-2510	BG Non-Locking Screw 2.5 x 10mm
P50-153-2512	BG Non-Locking Screw 2.5 x 12mm
P50-153-2514	BG Non-Locking Screw 2.5 x 14mm

Not all products available for sale in all markets. To determine availability in your marketplace, please contact your local Paragon 28 representative or email info@paragon28.com.

PROMO™ SCREWS

PART NUMBER	DESCRIPTION
P50-153-2516	BG Non-Locking Screw 2.5 x 16mm
P50-153-2518	BG Non-Locking Screw 2.5 x 18mm
P50-153-2520	BG Non-Locking Screw 2.5 x 20mm
P50-153-2522	BG Non-Locking Screw 2.5 x 22mm
P50-153-2524	BG Non-Locking Screw 2.5 x 24mm
P50-153-2526	BG Non-Locking Screw 2.5 x 26mm
P50-153-2528	BG Non-Locking Screw 2.5 x 28mm
P50-153-2530	BG Non-Locking Screw 2.5 x 30mm
P50-153-2532	BG Non-Locking Screw 2.5 x 32mm
P50-153-2534	BG Non-Locking Screw 2.5 x 34mm
P50-153-2536	BG Non-Locking Screw 2.5 x 36mm
P20-120-010S	Mini-Monster® Cannulated, Short Thread Screw, Headed, 2.0 x 10 mm
P20-120-012S	Mini-Monster® Cannulated, Short Thread Screw, Headed, 2.0 x 12 mm
P20-120-014S	Mini-Monster® Cannulated, Short Thread Screw, Headed, 2.0 x 14 mm
P20-120-016S	Mini-Monster® Cannulated, Short Thread Screw, Headed, 2.0 x 16 mm
P20-120-018S	Mini-Monster® Cannulated, Short Thread Screw, Headed, 2.0 x 18 mm
P20-120-020S	Mini-Monster® Cannulated, Short Thread Screw, Headed, 2.0 x 20 mm
P20-120-022S	Mini-Monster® Cannulated, Short Thread Screw, Headed, 2.0 x 22 mm
P20-120-024S	Mini-Monster® Cannulated, Short Thread Screw, Headed, 2.0 x 24 mm
P20-120-026S	Mini-Monster® Cannulated, Short Thread Screw, Headed, 2.0 x 26 mm
P20-120-028S	Mini-Monster® Cannulated, Short Thread Screw, Headed, 2.0 x 28 mm
P20-120-030S	Mini-Monster® Cannulated, Short Thread Screw, Headed, 2.0 x 30 mm
P20-120-032S	Mini-Monster® Cannulated, Short Thread Screw, Headed, 2.0 x 32 mm
P20-120-034S	Mini-Monster® Cannulated, Short Thread Screw, Headed, 2.0 x 34 mm
P20-120-036S	Mini-Monster® Cannulated, Short Thread Screw, Headed, 2.0 x 36 mm
P20-125-010S	Mini-Monster® Cannulated, Short Thread Screw, Headed, 2.5 x 10 mm
P20-125-012S	Mini-Monster® Cannulated, Short Thread Screw, Headed, 2.5 x 12 mm
P20-125-014S	Mini-Monster® Cannulated, Short Thread Screw, Headed, 2.5 x 14 mm
P20-125-016S	Mini-Monster® Cannulated, Short Thread Screw, Headed, 2.5 x 16 mm
P20-125-018S	Mini-Monster® Cannulated, Short Thread Screw, Headed, 2.5 x 18 mm
P20-125-020S	Mini-Monster® Cannulated, Short Thread Screw, Headed, 2.5 x 20 mm
P20-125-022S	Mini-Monster® Cannulated, Short Thread Screw, Headed, 2.5 x 22 mm
P20-125-024S	Mini-Monster® Cannulated, Short Thread Screw, Headed, 2.5 x 24 mm
P20-125-026S	Mini-Monster® Cannulated, Short Thread Screw, Headed, 2.5 x 26 mm
P20-125-028S	Mini-Monster® Cannulated, Short Thread Screw, Headed, 2.5 x 28 mm
P20-125-030S	Mini-Monster® Cannulated, Short Thread Screw, Headed, 2.5 x 30 mm
P20-125-032S	Mini-Monster® Cannulated, Short Thread Screw, Headed, 2.5 x 32 mm
P20-125-034S	Mini-Monster® Cannulated, Short Thread Screw, Headed, 2.5 x 34 mm
P20-125-036S	Mini-Monster® Cannulated, Short Thread Screw, Headed, 2.5 x 36 mm
P20-520-010S	Mini-Monster® Cannulated, Short Thread Screw, Headless, 2.0 x 10 mm

Not all products available for sale in all markets. To determine availability in your marketplace, please contact your local Paragon 28 representative or email info@paragon28.com.

PROMO™ SCREWS

PART NUMBER	DESCRIPTION
P20-520-012S	Mini-Monster® Cannulated, Short Thread Screw, Headless, 2.0 x 12 mm
P20-520-014S	Mini-Monster® Cannulated, Short Thread Screw, Headless, 2.0 x 14 mm
P20-520-016S	Mini-Monster® Cannulated, Short Thread Screw, Headless, 2.0 x 16 mm
P20-520-018S	Mini-Monster® Cannulated, Short Thread Screw, Headless, 2.0 x 18 mm
P20-520-020S	Mini-Monster® Cannulated, Short Thread Screw, Headless, 2.0 x 20 mm
P20-520-022S	Mini-Monster® Cannulated, Short Thread Screw, Headless, 2.0 x 22 mm
P20-520-024S	Mini-Monster® Cannulated, Short Thread Screw, Headless, 2.0 x 24 mm
P20-520-026S	Mini-Monster® Cannulated, Short Thread Screw, Headless, 2.0 x 26 mm
P20-520-028S	Mini-Monster® Cannulated, Short Thread Screw, Headless, 2.0 x 28 mm
P20-520-030S	Mini-Monster® Cannulated, Short Thread Screw, Headless, 2.0 x 30 mm
P20-520-032S	Mini-Monster® Cannulated, Short Thread Screw, Headless, 2.0 x 32 mm
P20-520-034S	Mini-Monster® Cannulated, Short Thread Screw, Headless, 2.0 x 34 mm
P20-520-036S	Mini-Monster® Cannulated, Short Thread Screw, Headless, 2.0 x 36 mm
P20-525-010S	Mini-Monster® Cannulated, Short Thread Screw, Headless, 2.5 x 10 mm
P20-525-012S	Mini-Monster® Cannulated, Short Thread Screw, Headless, 2.5 x 12 mm
P20-525-014S	Mini-Monster® Cannulated, Short Thread Screw, Headless, 2.5 x 14 mm
P20-525-016S	Mini-Monster® Cannulated, Short Thread Screw, Headless, 2.5 x 16 mm
P20-525-018S	Mini-Monster® Cannulated, Short Thread Screw, Headless, 2.5 x 18 mm
P20-525-020S	Mini-Monster® Cannulated, Short Thread Screw, Headless, 2.5 x 20 mm
P20-525-022S	Mini-Monster® Cannulated, Short Thread Screw, Headless, 2.5 x 22 mm
P20-525-024S	Mini-Monster® Cannulated, Short Thread Screw, Headless, 2.5 x 24 mm
P20-525-026S	Mini-Monster® Cannulated, Short Thread Screw, Headless, 2.5 x 26 mm
P20-525-028S	Mini-Monster® Cannulated, Short Thread Screw, Headless, 2.5 x 28 mm
P20-525-030S	Mini-Monster® Cannulated, Short Thread Screw, Headless, 2.5 x 30 mm
P20-525-032S	Mini-Monster® Cannulated, Short Thread Screw, Headless, 2.5 x 32 mm
P20-525-034S	Mini-Monster® Cannulated, Short Thread Screw, Headless, 2.5 x 34 mm
P20-525-036S	Mini-Monster® Cannulated, Short Thread Screw, Headless, 2.5 x 36 mm

**JUMP TO PROMO LOCKING
STERILE PACKAGED PRODUCT**



**JUMPTOPROMOCANNULATED
STERILE PACKAGED PRODUCT**



PROMO™ INSTRUMENTS AND TRAY

PART NUMBER	DESCRIPTION
P50-900-3001	Baby Gorilla Case Lid
P50-900-3101	Promo, Plate Caddy & Instrument Tray
P50-900-3102	Promo, Case Base
P99-900-1006	Radiolucent Plantigrade foot
P99-000-AORC	Mini-AO Ratcheting Handle Streamline Cannulated
P99-000-AOMN	Mini-AO Ratcheting Handle Streamline, Cannulated, Medium
P99-150-0013	Sharp Tip Bone Reduction Clamp
P99-150-0017	Lobster Claw
P51-910-0003	Baby Gorilla, Plate Bender, Pliers



**BACK TO TABLE
OF CONTENTS**

Section 8:
**HAMMERTUBE™
IMPLANT SYSTEM**

Not all products available for sale in all markets. To determine availability in your marketplace, please contact your local Paragon 28 representative or email info@paragon28.com.



2.75 HammerTube™
Straight



2.75 HammerTube™
Angled



3.50 HammerTube™
Straight



3.50 HammerTube™
Angled

HAMMERTUBE™ IMPLANTS

PART NUMBER	DESCRIPTION
P40-001-0275-S	Ø2.75 Hammertube PEEK Implant, 0°, Sterile Packaged
P40-001-0350-S	Ø3.50 Hammertube PEEK Implant, 0°, Sterile Packaged
P40-002-0275-S	Ø2.75 Hammertube PEEK Implant, 10°, Sterile Packaged
P40-002-0350-S	Ø3.50 Hammertube PEEK Implant, 10°, Sterile Packaged

HAMMERTUBE™ INSTRUMENTS

PART NUMBER	DESCRIPTION
P40-CAD-BASE	Hammertoe, Caddy, Base
P40-CAD-INS1	Hammertoe, Caddy, Insert
P40-CAD-LID1	Hammertoe, Caddy, Lid
P40-293-1103	HammerToe, K-wire, Ø1.1 x 30mm, Double Blunt Tip, Smooth, SS
P40-293-1403	HammerToe, K-wire, Ø1.4 x 30mm, Double Blunt Tip, Smooth, SS
P40-293-1603	HammerToe, K-wire, Ø1.6 x 30mm, Double Blunt Tip, Smooth, SS
P40-900-0801	HammerToe, Planer, Ø8mm, Cannulated Trocar Insert (AO), SS
P40-900-2300	HammerToe, Inserter, Ø2.30mm, Radel
P40-900-2750	HammerToe, Inserter, Ø2.75mm, Radel
P40-900-2800	HammerToe, Inserter, Ø2.80mm, Radel
P40-900-3500	HammerToe, Inserter, Ø3.50mm, Radel
P40-910-0002	HammerToe, Implant Puller, SS
P40-920-2107	HammerToe, Drill, Ø2.15 X 70mm, Cannulated Trocar Insert (AO), SS
P40-920-2607	HammerToe, Drill, Ø2.65 X 70mm, Cannulated Trocar Insert (AO), SS
P40-920-2707	HammerToe, Drill, Ø2.75 X 70mm, Cannulated Trocar Insert (AO), SS
P40-920-3507	HammerToe, Drill, Ø3.50 X 70mm, Cannulated Trocar Insert (AO), SS
P99-195-1107	P28, Trocar Insert, Ø1.10 x 70mm (AO), SS
P99-195-1407	P28, Trocar Insert, Ø1.40 x 70mm (AO), SS
P99-195-1607	P28, Trocar Insert, Ø1.60 x 70mm (AO), SS
P99-292-1115	P28, K-wire, Ø1.1 x 150mm, Double Trocar, Smooth, SS
P99-292-1415	P28, K-wire, Ø1.4 x 150mm, Double Trocar, Smooth, SS
P99-292-1615	P28, K-wire, Ø1.6 x 150mm, Double Trocar, Smooth, SS
P99-150-0005	P28, K-Wire Hole Gauge & Ruler, SS

Not all products available for sale in all markets. To determine availability in your marketplace, please contact your local Paragon 28 representative or email info@paragon28.com.



Implant Extractor

Trepine, Ø2.75

Trepine, Ø3.50

HAMMERTUBE™ REVISION INSTRUMENTS

PART NUMBER	DESCRIPTION
P40-CAD-REVS	HammerToe, Caddy, Revision /Removal, Base
P40-CAD-LID1	HammerToe, Caddy, Lid
P40-910-0001	HammerToe, Implant Extractor, SS
P40-910-0002	HammerToe, Implant Puller, SS
P40-910-2750	HammerToe, Trepine, Ø2.75, Cannulated Trocar Insert (AO), SS
P40-910-3500	HammerToe, Trepine, Ø3.50, Cannulated Trocar Insert, (AO), SS
P99-195-1407	P28, Trocar Insert, Ø1.40 x 70mm (AO), SS
P99-195-1607	P28, Trocar Insert, Ø1.60 x 70mm (AO), SS

Section 9:
**PRECISION JONES™
FRACTURE SCREW
SYSTEM**

Not all products available for sale in all markets. To determine availability in your marketplace, please contact your local Paragon 28 representative or email info@paragon28.com.



4.0 mm
JMF Screw



4.5 mm
JMF Screw



5.5 mm
JMF Screw



6.2 mm
JMF Screw

PRECISION JONES™ FRACTURE SCREWS (CANNULATED)

PART NUMBER	DESCRIPTION
P25-900-SCBC	Precision Jones Screw System Cannulated Screw Caddy Base
P25-900-SCCL	Precision Jones Screw System Screw Caddy Lid
P25-240-034S	Monster, Screw, Ø4.0 x 34mm, Headed, Short Thd, Cannulated, Blunt Tip, TiA
P25-240-036S	Monster, Screw, Ø4.0 x 36mm, Headed, Short Thd, Cannulated, Blunt Tip, TiA
P25-240-038S	Monster, Screw, Ø4.0 x 38mm, Headed, Short Thd, Cannulated, Blunt Tip, TiA
P25-240-040S	Monster, Screw, Ø4.0 x 40mm, Headed, Short Thd, Cannulated, Blunt Tip, TiA
P25-240-042S	Monster, Screw, Ø4.0 x 42mm, Headed, Short Thd, Cannulated, Blunt Tip, TiA
P25-240-044S	Monster, Screw, Ø4.0 x 44mm, Headed, Short Thd, Cannulated, Blunt Tip, TiA
P25-240-046S	Monster, Screw, Ø4.0 x 46mm, Headed, Short Thd, Cannulated, Blunt Tip, TiA
P25-240-048S	Monster, Screw, Ø4.0 x 48mm, Headed, Short Thd, Cannulated, Blunt Tip, TiA
P25-240-050S	Monster, Screw, Ø4.0 x 50mm, Headed, Short Thd, Cannulated, Blunt Tip, TiA
P25-240-052S	Monster, Screw, Ø4.0 x 52mm, Headed, Short Thd, Cannulated, Blunt Tip, TiA
P25-240-054S	Monster, Screw, Ø4.0 x 54mm, Headed, Short Thd, Cannulated, Blunt Tip, TiA
P25-240-056S	Monster, Screw, Ø4.0 x 56mm, Headed, Short Thd, Cannulated, Blunt Tip, TiA
P25-240-058S	Monster, Screw, Ø4.0 x 58mm, Headed, Short Thd, Cannulated, Blunt Tip, TiA
P25-240-060S	Monster, Screw, Ø4.0 x 60mm, Headed, Short Thd, Cannulated, Blunt Tip, TiA
P25-240-065S	Monster, Screw, Ø4.0 x 65mm, Headed, Short Thd, Cannulated, Blunt Tip, TiA
P25-245-034S	Monster, Screw, Ø4.5 x 34mm, Headed, Short Thd, Cannulated, Blunt Tip, TiA
P25-245-036S	Monster, Screw, Ø4.5 x 36mm, Headed, Short Thd, Cannulated, Blunt Tip, TiA
P25-245-038S	Monster, Screw, Ø4.5 x 38mm, Headed, Short Thd, Cannulated, Blunt Tip, TiA
P25-245-040S	Monster, Screw, Ø4.5 x 40mm, Headed, Short Thd, Cannulated, Blunt Tip, TiA
P25-245-042S	Monster, Screw, Ø4.5 x 42mm, Headed, Short Thd, Cannulated, Blunt Tip, TiA
P25-245-044S	Monster, Screw, Ø4.5 x 44mm, Headed, Short Thd, Cannulated, Blunt Tip, TiA
P25-245-046S	Monster, Screw, Ø4.5 x 46mm, Headed, Short Thd, Cannulated, Blunt Tip, TiA
P25-245-048S	Monster, Screw, Ø4.5 x 48mm, Headed, Short Thd, Cannulated, Blunt Tip, TiA
P25-245-050S	Monster, Screw, Ø4.5 x 50mm, Headed, Short Thd, Cannulated, Blunt Tip, TiA
P25-245-052S	Monster, Screw, Ø4.5 x 52mm, Headed, Short Thd, Cannulated, Blunt Tip, TiA
P25-245-054S	Monster, Screw, Ø4.5 x 54mm, Headed, Short Thd, Cannulated, Blunt Tip, TiA
P25-245-056S	Monster, Screw, Ø4.5 x 56mm, Headed, Short Thd, Cannulated, Blunt Tip, TiA
P25-245-058S	Monster, Screw, Ø4.5 x 58mm, Headed, Short Thd, Cannulated, Blunt Tip, TiA

Not all products available for sale in all markets. To determine availability in your marketplace, please contact your local Paragon 28 representative or email info@paragon28.com.

PRECISION JONES™ FRACTURE SCREWS (CANNULATED)

PART NUMBER	DESCRIPTION
P25-245-060S	Monster, Screw, Ø4.5 x 60mm, Headed, Short Thd, Cannulated, Blunt Tip, TiA
P25-245-065S	Monster, Screw, Ø4.5 x 65mm, Headed, Short Thd, Cannulated, Blunt Tip, TiA
P25-255-034S	Monster, Screw, Ø5.5 x 34mm, Headed, Short Thd, Cannulated, Blunt Tip, TiA
P25-255-036S	Monster, Screw, Ø5.5 x 36mm, Headed, Short Thd, Cannulated, Blunt Tip, TiA
P25-255-038S	Monster, Screw, Ø5.5 x 38mm, Headed, Short Thd, Cannulated, Blunt Tip, TiA
P25-255-040S	Monster, Screw, Ø5.5 x 40mm, Headed, Short Thd, Cannulated, Blunt Tip, TiA
P25-255-042S	Monster, Screw, Ø5.5 x 42mm, Headed, Short Thd, Cannulated, Blunt Tip, TiA
P25-255-044S	Monster, Screw, Ø5.5 x 44mm, Headed, Short Thd, Cannulated, Blunt Tip, TiA
P25-255-046S	Monster, Screw, Ø5.5 x 46mm, Headed, Short Thd, Cannulated, Blunt Tip, TiA
P25-255-048S	Monster, Screw, Ø5.5 x 48mm, Headed, Short Thd, Cannulated, Blunt Tip, TiA
P25-255-050S	Monster, Screw, Ø5.5 x 50mm, Headed, Short Thd, Cannulated, Blunt Tip, TiA
P25-255-052S	Monster, Screw, Ø5.5 x 52mm, Headed, Short Thd, Cannulated, Blunt Tip, TiA
P25-255-054S	Monster, Screw, Ø5.5 x 54mm, Headed, Short Thd, Cannulated, Blunt Tip, TiA
P25-255-056S	Monster, Screw, Ø5.5 x 56mm, Headed, Short Thd, Cannulated, Blunt Tip, TiA
P25-255-058S	Monster, Screw, Ø5.5 x 58mm, Headed, Short Thd, Cannulated, Blunt Tip, TiA
P25-255-060S	Monster, Screw, Ø5.5 x 60mm, Headed, Short Thd, Cannulated, Blunt Tip, TiA
P25-255-065S	Monster, Screw, Ø5.5 x 65mm, Headed, Short Thd, Cannulated, Blunt Tip, TiA
P25-262-034S	Monster, Screw, Ø6.2 x 34mm, Headed, Short Thd, Cannulated, Blunt Tip, TiA
P25-262-036S	Monster, Screw, Ø6.2 x 36mm, Headed, Short Thd, Cannulated, Blunt Tip, TiA
P25-262-038S	Monster, Screw, Ø6.2 x 38mm, Headed, Short Thd, Cannulated, Blunt Tip, TiA
P25-262-040S	Monster, Screw, Ø6.2 x 40mm, Headed, Short Thd, Cannulated, Blunt Tip, TiA
P25-262-042S	Monster, Screw, Ø6.2 x 42mm, Headed, Short Thd, Cannulated, Blunt Tip, TiA
P25-262-044S	Monster, Screw, Ø6.2 x 44mm, Headed, Short Thd, Cannulated, Blunt Tip, TiA
P25-262-046S	Monster, Screw, Ø6.2 x 46mm, Headed, Short Thd, Cannulated, Blunt Tip, TiA
P25-262-048S	Monster, Screw, Ø6.2 x 48mm, Headed, Short Thd, Cannulated, Blunt Tip, TiA
P25-262-050S	Monster, Screw, Ø6.2 x 50mm, Headed, Short Thd, Cannulated, Blunt Tip, TiA
P25-262-052S	Monster, Screw, Ø6.2 x 52mm, Headed, Short Thd, Cannulated, Blunt Tip, TiA
P25-262-054S	Monster, Screw, Ø6.2 x 54mm, Headed, Short Thd, Cannulated, Blunt Tip, TiA
P25-262-056S	Monster, Screw, Ø6.2 x 56mm, Headed, Short Thd, Cannulated, Blunt Tip, TiA
P25-262-058S	Monster, Screw, Ø6.2 x 58mm, Headed, Short Thd, Cannulated, Blunt Tip, TiA
P25-262-060S	Monster, Screw, Ø6.2 x 60mm, Headed, Short Thd, Cannulated, Blunt Tip, TiA
P25-262-065S	Monster, Screw, Ø6.2 x 65mm, Headed, Short Thd, Cannulated, Blunt Tip, TiA



Not all products available for sale in all markets. To determine availability in your marketplace, please contact your local Paragon 28 representative or email info@paragon28.com.



4.0 mm
JMF Screw



4.5 mm
JMF Screw



5.5 mm
JMF Screw



6.2 mm
JMF Screw

PRECISION JONES™ FRACTURE SCREWS (SOLID)

PART NUMBER	DESCRIPTION
P25-900-SCBS	Precision Jones Screw System Solid Screw Caddy Base
P25-900-SCCL	Precision Jones Screw System Screw Caddy Lid
P25-440-034S	Monster, Screw, Ø4.0 x 34mm, Headed, Short Thd, Solid, Blunt Tip, TiA
P25-440-036S	Monster, Screw, Ø4.0 x 36mm, Headed, Short Thd, Solid, Blunt Tip, TiA
P25-440-038S	Monster, Screw, Ø4.0 x 38mm, Headed, Short Thd, Solid, Blunt Tip, TiA
P25-440-040S	Monster, Screw, Ø4.0 x 40mm, Headed, Short Thd, Solid, Blunt Tip, TiA
P25-440-042S	Monster, Screw, Ø4.0 x 42mm, Headed, Short Thd, Solid, Blunt Tip, TiA
P25-440-044S	Monster, Screw, Ø4.0 x 44mm, Headed, Short Thd, Solid, Blunt Tip, TiA
P25-440-046S	Monster, Screw, Ø4.0 x 46mm, Headed, Short Thd, Solid, Blunt Tip, TiA
P25-440-048S	Monster, Screw, Ø4.0 x 48mm, Headed, Short Thd, Solid, Blunt Tip, TiA
P25-440-050S	Monster, Screw, Ø4.0 x 50mm, Headed, Short Thd, Solid, Blunt Tip, TiA
P25-440-052S	Monster, Screw, Ø4.0 x 52mm, Headed, Short Thd, Solid, Blunt Tip, TiA
P25-440-054S	Monster, Screw, Ø4.0 x 54mm, Headed, Short Thd, Solid, Blunt Tip, TiA
P25-440-056S	Monster, Screw, Ø4.0 x 56mm, Headed, Short Thd, Solid, Blunt Tip, TiA
P25-440-058S	Monster, Screw, Ø4.0 x 58mm, Headed, Short Thd, Solid, Blunt Tip, TiA
P25-440-060S	Monster, Screw, Ø4.0 x 60mm, Headed, Short Thd, Solid, Blunt Tip, TiA
P25-440-065S	Monster, Screw, Ø4.0 x 65mm, Headed, Short Thd, Solid, Blunt Tip, TiA
P25-445-034S	Monster, Screw, Ø4.5 x 34mm, Headed, Short Thd, Solid, Blunt Tip, TiA
P25-445-036S	Monster, Screw, Ø4.5 x 36mm, Headed, Short Thd, Solid, Blunt Tip, TiA
P25-445-038S	Monster, Screw, Ø4.5 x 38mm, Headed, Short Thd, Solid, Blunt Tip, TiA
P25-445-040S	Monster, Screw, Ø4.5 x 40mm, Headed, Short Thd, Solid, Blunt Tip, TiA
P25-445-042S	Monster, Screw, Ø4.5 x 42mm, Headed, Short Thd, Solid, Blunt Tip, TiA
P25-445-044S	Monster, Screw, Ø4.5 x 44mm, Headed, Short Thd, Solid, Blunt Tip, TiA
P25-445-046S	Monster, Screw, Ø4.5 x 46mm, Headed, Short Thd, Solid, Blunt Tip, TiA
P25-445-048S	Monster, Screw, Ø4.5 x 48mm, Headed, Short Thd, Solid, Blunt Tip, TiA
P25-445-050S	Monster, Screw, Ø4.5 x 50mm, Headed, Short Thd, Solid, Blunt Tip, TiA
P25-445-052S	Monster, Screw, Ø4.5 x 52mm, Headed, Short Thd, Solid, Blunt Tip, TiA
P25-445-054S	Monster, Screw, Ø4.5 x 54mm, Headed, Short Thd, Solid, Blunt Tip, TiA
P25-445-056S	Monster, Screw, Ø4.5 x 56mm, Headed, Short Thd, Solid, Blunt Tip, TiA
P25-445-058S	Monster, Screw, Ø4.5 x 58mm, Headed, Short Thd, Solid, Blunt Tip, TiA

Not all products available for sale in all markets. To determine availability in your marketplace, please contact your local Paragon 28 representative or email info@paragon28.com.

PRECISION JONES™ FRACTURE SCREWS (SOLID)

PART NUMBER	DESCRIPTION
P25-445-060S	Monster, Screw, Ø4.5 x 60mm, Headed, Short Thd, Solid, Blunt Tip, TiA
P25-445-065S	Monster, Screw, Ø4.5 x 65mm, Headed, Short Thd, Solid, Blunt Tip, TiA
P25-455-034S	Monster, Screw, Ø5.5 x 34mm, Headed, Short Thd, Solid, Blunt Tip, TiA
P25-455-036S	Monster, Screw, Ø5.5 x 36mm, Headed, Short Thd, Solid, Blunt Tip, TiA
P25-455-038S	Monster, Screw, Ø5.5 x 38mm, Headed, Short Thd, Solid, Blunt Tip, TiA
P25-455-040S	Monster, Screw, Ø5.5 x 40mm, Headed, Short Thd, Solid, Blunt Tip, TiA
P25-455-042S	Monster, Screw, Ø5.5 x 42mm, Headed, Short Thd, Solid, Blunt Tip, TiA
P25-455-044S	Monster, Screw, Ø5.5 x 44mm, Headed, Short Thd, Solid, Blunt Tip, TiA
P25-455-046S	Monster, Screw, Ø5.5 x 46mm, Headed, Short Thd, Solid, Blunt Tip, TiA
P25-455-048S	Monster, Screw, Ø5.5 x 48mm, Headed, Short Thd, Solid, Blunt Tip, TiA
P25-455-050S	Monster, Screw, Ø5.5 x 50mm, Headed, Short Thd, Solid, Blunt Tip, TiA
P25-455-052S	Monster, Screw, Ø5.5 x 52mm, Headed, Short Thd, Solid, Blunt Tip, TiA
P25-455-054S	Monster, Screw, Ø5.5 x 54mm, Headed, Short Thd, Solid, Blunt Tip, TiA
P25-455-056S	Monster, Screw, Ø5.5 x 56mm, Headed, Short Thd, Solid, Blunt Tip, TiA
P25-455-058S	Monster, Screw, Ø5.5 x 58mm, Headed, Short Thd, Solid, Blunt Tip, TiA
P25-455-060S	Monster, Screw, Ø5.5 x 60mm, Headed, Short Thd, Solid, Blunt Tip, TiA
P25-455-065S	Monster, Screw, Ø5.5 x 65mm, Headed, Short Thd, Solid, Blunt Tip, TiA
P25-462-034S	Monster, Screw, Ø6.2 x 34mm, Headed, Short Thd, Solid, Blunt Tip, TiA
P25-462-036S	Monster, Screw, Ø6.2 x 36mm, Headed, Short Thd, Solid, Blunt Tip, TiA
P25-462-038S	Monster, Screw, Ø6.2 x 38mm, Headed, Short Thd, Solid, Blunt Tip, TiA
P25-462-040S	Monster, Screw, Ø6.2 x 40mm, Headed, Short Thd, Solid, Blunt Tip, TiA
P25-462-042S	Monster, Screw, Ø6.2 x 42mm, Headed, Short Thd, Solid, Blunt Tip, TiA
P25-462-044S	Monster, Screw, Ø6.2 x 44mm, Headed, Short Thd, Solid, Blunt Tip, TiA
P25-462-046S	Monster, Screw, Ø6.2 x 46mm, Headed, Short Thd, Solid, Blunt Tip, TiA
P25-462-048S	Monster, Screw, Ø6.2 x 48mm, Headed, Short Thd, Solid, Blunt Tip, TiA
P25-462-050S	Monster, Screw, Ø6.2 x 50mm, Headed, Short Thd, Solid, Blunt Tip, TiA
P25-462-052S	Monster, Screw, Ø6.2 x 52mm, Headed, Short Thd, Solid, Blunt Tip, TiA
P25-462-054S	Monster, Screw, Ø6.2 x 54mm, Headed, Short Thd, Solid, Blunt Tip, TiA
P25-462-056S	Monster, Screw, Ø6.2 x 56mm, Headed, Short Thd, Solid, Blunt Tip, TiA
P25-462-058S	Monster, Screw, Ø6.2 x 58mm, Headed, Short Thd, Solid, Blunt Tip, TiA
P25-462-060S	Monster, Screw, Ø6.2 x 60mm, Headed, Short Thd, Solid, Blunt Tip, TiA
P25-462-065S	Monster, Screw, Ø6.2 x 65mm, Headed, Short Thd, Solid, Blunt Tip, TiA



Not all products available for sale in all markets. To determine availability in your marketplace, please contact your local Paragon 28 representative or email info@paragon28.com.

PRECISION JONES™ FRACTURE INSTRUMENTS

PART NUMBER	DESCRIPTION
P25-900-CASE	Precision Jones Screw System Case Base
P25-900-CASL	Precision Jones Screw System Case Lid
P25-900-TRAY	Precision Jones Screw System Instrument Tray
P25-900-WSCD	Precision Jones Screw System Washer Caddy
P25-900-WSCL	Precision Jones Screw System Washer Caddy Lid
P25-900-TUBE	Precision Jones Screw System K-Wire Tube
P20-900-5006	ø0.9mm & ø1.2mm K-Wire Tube Cap
P25-910-4045	Countersink, Ø4.0/4.5mm, Headed, SS
P25-910-5500	Countersink, Ø5.5mm, Headed, SS
P25-910-6200	Countersink, Ø6.2mm, Headed, SS
P25-920-4000	Tap, Ø4.0mm, SS
P25-920-4500	Tap, Ø4.5mm, SS
P25-920-5500	Tap, Ø5.5mm, SS
P25-920-6200	Tap, Ø6.2mm, SS
P25-930-4000	Tissue Protector, Ø4.0mm, SS
P25-930-4500	Tissue Protector, Ø4.5mm, SS
P25-930-5500	Tissue Protector, Ø5.5mm, SS
P25-930-6200	Tissue Protector, Ø6.2mm, SS
P25-931-4000	Drill Guide, Ø4.0mm, SS
P25-931-4500	Drill Guide, Ø4.5mm, SS
P25-931-5500	Drill Guide, Ø5.5mm, SS
P25-931-6200	Drill Guide, Ø6.2mm, SS
P25-932-0001	Curved K-Wire Guide
P25-951-4062	Depth Gauge, K-Wire Measuring, SS
P99-000-316A	P28, Jacobs Adapter, 3/16 Sq, Cannulated, SS
P99-000-316L	Large Axial Ratchet Handle
P99-000-316M	Medium Axial Ratchet Handle
P99-110-2815	P28, Drill, Ø2.8mm x 15mm, Cannulated SS
P99-110-3215	P28, Drill, Ø3.2mm x 15mm, Cannulated SS
P99-110-3815	P28, Drill, Ø3.8mm x 15mm, Cannulated SS
P99-110-4215	P28, Drill, Ø4.2mm x 15mm, Cannulated SS
P99-150-0001	P28, Screw Forceps, Ti
P99-172-1520	ø1.5mm X 200mm Nitinol K-Wire, Smooth
P99-190-TJ15	P28, Driver, HX15, Cannulated, SS
P99-190-TJ25	P28, Driver, HX25, Cannulated, SS
P25-930-GEN1	Tissue Protector, General, SS
P20-045-WD00	Monster, Washer, 4.5mm, Dome, TiA
P20-055-WD00	Monster, Washer, 5.5mm, Dome, TiA
P20-060-WD00	Monster, Washer, 6.0mm, Dome, TiA

Section 10:
**JOUST BEAMING
SCREW™ SYSTEM**

Not all products available for sale in all markets. To determine availability in your marketplace, please contact your local Paragon 28 representative or email info@paragon28.com.



5.0 fully and partially threaded beams

5.5 fully and partially threaded beams

5.0/5.5 JOUST BEAMING SCREWS™

PART NUMBER	DESCRIPTION
P26-900-IMPB	Monster® Beam, Implant Case Base
P26-900-50CN	Beaming, Implant Tray, Ø5.0 Cannulated, All Thread
P26-550-050F	Monster® Beam, Cannulated, Headless, Full Thd, 5.0 x 50mm
P26-550-050M	Monster® Beam, Cannulated, Headless, Medium Thd, 5.0 x 50mm
P26-550-055F	Monster® Beam, Cannulated, Headless, Full Thd, 5.0 x 55mm
P26-550-055M	Monster® Beam, Cannulated, Headless, Medium Thd, 5.0 x 55mm
P26-550-060F	Monster® Beam, Cannulated, Headless, Full Thd, 5.0 x 60mm
P26-550-060M	Monster® Beam, Cannulated, Headless, Medium Thd, 5.0 x 60mm
P26-550-065F	Monster® Beam, Cannulated, Headless, Full Thd, 5.0 x 65mm
P26-550-065M	Monster® Beam, Cannulated, Headless, Medium Thd, 5.0 x 65mm
P26-550-070F	Monster® Beam, Cannulated, Headless, Full Thd, 5.0 x 70mm
P26-550-070M	Monster® Beam, Cannulated, Headless, Medium Thd, 5.0 x 70mm
P26-550-075F	Monster® Beam, Cannulated, Headless, Full Thd, 5.0 x 75mm
P26-550-075M	Monster® Beam, Cannulated, Headless, Medium Thd, 5.0 x 75mm
P26-550-080F	Monster® Beam, Cannulated, Headless, Full Thd, 5.0 x 80mm
P26-550-080M	Monster® Beam, Cannulated, Headless, Medium Thd, 5.0 x 80mm
P26-550-085F	Monster® Beam, Cannulated, Headless, Full Thd, 5.0 x 85mm
P26-550-085M	Monster® Beam, Cannulated, Headless, Medium Thd, 5.0 x 85mm
P26-550-090F	Monster® Beam, Cannulated, Headless, Full Thd, 5.0 x 90mm
P26-550-090M	Monster® Beam, Cannulated, Headless, Medium Thd, 5.0 x 90mm
P26-550-095F	Monster® Beam, Cannulated, Headless, Full Thd, 5.0 x 95mm
P26-550-095M	Monster® Beam, Cannulated, Headless, Medium Thd, 5.0 x 95mm
P26-550-100F	Monster® Beam, Cannulated, Headless, Full Thd, 5.0 x 100mm
P26-550-100M	Monster® Beam, Cannulated, Headless, Medium Thd, 5.0 x 100mm
P26-550-105F	Monster® Beam, Cannulated, Headless, Full Thd, 5.0 x 105mm
P26-550-105M	Monster® Beam, Cannulated, Headless, Medium Thd, 5.0 x 105mm
P26-550-110F	Monster® Beam, Cannulated, Headless, Full Thd, 5.0 x 110mm
P26-550-110M	Monster® Beam, Cannulated, Headless, Medium Thd, 5.0 x 110mm
P26-550-115F	Monster® Beam, Cannulated, Headless, Full Thd, 5.0 x 115mm
P26-550-115M	Monster® Beam, Cannulated, Headless, Medium Thd, 5.0 x 115mm

Not all products available for sale in all markets. To determine availability in your marketplace, please contact your local Paragon 28 representative or email info@paragon28.com.

5.0/5.5 JOUST BEAMING SCREWS™

PART NUMBER	DESCRIPTION
P26-550-120F	Monster® Beam, Cannulated, Headless, Full Thd, 5.0 x 120mm
P26-550-120M	Monster® Beam, Cannulated, Headless, Medium Thd, 5.0 x 120mm
P26-900-50SL	Beaming, Implant Tray, Ø5.0 Solid, All Thread
P26-750-050F	Monster® Beam, Solid, Headless, Full Thd, 5.0 x 50mm
P26-750-050M	Monster® Beam, Solid, Headless, Medium Thd, 5.0 x 50mm
P26-750-055F	Monster® Beam, Solid, Headless, Full Thd, 5.0 x 55mm
P26-750-055M	Monster® Beam, Solid, Headless, Medium Thd, 5.0 x 55mm
P26-750-060F	Monster® Beam, Solid, Headless, Full Thd, 5.0 x 60mm
P26-750-060M	Monster® Beam, Solid, Headless, Medium Thd, 5.0 x 60mm
P26-750-065F	Monster® Beam, Solid, Headless, Full Thd, 5.0 x 65mm
P26-750-065M	Monster® Beam, Solid, Headless, Medium Thd, 5.0 x 65mm
P26-750-070F	Monster® Beam, Solid, Headless, Full Thd, 5.0 x 70mm
P26-750-070M	Monster® Beam, Solid, Headless, Medium Thd, 5.0 x 70mm
P26-750-075F	Monster® Beam, Solid, Headless, Full Thd, 5.0 x 75mm
P26-750-075M	Monster® Beam, Solid, Headless, Medium Thd, 5.0 x 75mm
P26-750-080F	Monster® Beam, Solid, Headless, Full Thd, 5.0 x 80mm
P26-750-080M	Monster® Beam, Solid, Headless, Medium Thd, 5.0 x 80mm
P26-750-085F	Monster® Beam, Solid, Headless, Full Thd, 5.0 x 85mm
P26-750-085M	Monster® Beam, Solid, Headless, Medium Thd, 5.0 x 85mm
P26-750-090F	Monster® Beam, Solid, Headless, Full Thd, 5.0 x 90mm
P26-750-090M	Monster® Beam, Solid, Headless, Medium Thd, 5.0 x 90mm
P26-750-095F	Monster® Beam, Solid, Headless, Full Thd, 5.0 x 95mm
P26-750-095M	Monster® Beam, Solid, Headless, Medium Thd, 5.0 x 95mm
P26-750-100F	Monster® Beam, Solid, Headless, Full Thd, 5.0 x 100mm
P26-750-100M	Monster® Beam, Solid, Headless, Medium Thd, 5.0 x 100mm
P26-750-105F	Monster® Beam, Solid, Headless, Full Thd, 5.0 x 105mm
P26-750-105M	Monster® Beam, Solid, Headless, Medium Thd, 5.0 x 105mm
P26-750-110F	Monster® Beam, Solid, Headless, Full Thd, 5.0 x 110mm
P26-750-110M	Monster® Beam, Solid, Headless, Medium Thd, 5.0 x 110mm
P26-750-115F	Monster® Beam, Solid, Headless, Full Thd, 5.0 x 115mm
P26-750-115M	Monster® Beam, Solid, Headless, Medium Thd, 5.0 x 115mm
P26-750-120F	Monster® Beam, Solid, Headless, Full Thd, 5.0 x 120mm
P26-750-120M	Monster® Beam, Solid, Headless, Medium Thd, 5.0 x 120mm
P26-900-55CN	Beaming, Implant Tray, Ø5.5 Cannulated, All Thread
P26-555-050F	Monster® Beam, Cannulated, Headless, Full Thd, 5.5 x 50mm
P26-555-050M	Monster® Beam, Cannulated, Headless, Medium Thd, 5.5 x 50mm
P26-555-055F	Monster® Beam, Cannulated, Headless, Full Thd, 5.5 x 55mm
P26-555-055M	Monster® Beam, Cannulated, Headless, Medium Thd, 5.5 x 55mm
P26-555-060F	Monster® Beam, Cannulated, Headless, Full Thd, 5.5 x 60mm
P26-555-060M	Monster® Beam, Cannulated, Headless, Medium Thd, 5.5 x 60mm

Not all products available for sale in all markets. To determine availability in your marketplace, please contact your local Paragon 28 representative or email info@paragon28.com.

5.0/5.5 JOUST BEAMING SCREWS™

PART NUMBER	DESCRIPTION
P26-555-065F	Monster® Beam, Cannulated, Headless, Full Thd, 5.5 x 65mm
P26-555-065M	Monster® Beam, Cannulated, Headless, Medium Thd, 5.5 x 65mm
P26-555-070F	Monster® Beam, Cannulated, Headless, Full Thd, 5.5 x 70mm
P26-555-070M	Monster® Beam, Cannulated, Headless, Medium Thd, 5.5 x 70mm
P26-555-075F	Monster® Beam, Cannulated, Headless, Full Thd, 5.5 x 75mm
P26-555-075M	Monster® Beam, Cannulated, Headless, Medium Thd, 5.5 x 75mm
P26-555-080F	Monster® Beam, Cannulated, Headless, Full Thd, 5.5 x 80mm
P26-555-080M	Monster® Beam, Cannulated, Headless, Medium Thd, 5.5 x 80mm
P26-555-085F	Monster® Beam, Cannulated, Headless, Full Thd, 5.5 x 85mm
P26-555-085M	Monster® Beam, Cannulated, Headless, Medium Thd, 5.5 x 85mm
P26-555-090F	Monster® Beam, Cannulated, Headless, Full Thd, 5.5 x 90mm
P26-555-090M	Monster® Beam, Cannulated, Headless, Medium Thd, 5.5 x 90mm
P26-555-095F	Monster® Beam, Cannulated, Headless, Full Thd, 5.5 x 95mm
P26-555-095M	Monster® Beam, Cannulated, Headless, Medium Thd, 5.5 x 95mm
P26-555-100F	Monster® Beam, Cannulated, Headless, Full Thd, 5.5 x 100mm
P26-555-100M	Monster® Beam, Cannulated, Headless, Medium Thd, 5.5 x 100mm
P26-555-105F	Monster® Beam, Cannulated, Headless, Full Thd, 5.5 x 105mm
P26-555-105M	Monster® Beam, Cannulated, Headless, Medium Thd, 5.5 x 105mm
P26-555-110F	Monster® Beam, Cannulated, Headless, Full Thd, 5.5 x 110mm
P26-555-110M	Monster® Beam, Cannulated, Headless, Medium Thd, 5.5 x 110mm
P26-555-115F	Monster® Beam, Cannulated, Headless, Full Thd, 5.5 x 115mm
P26-555-115M	Monster® Beam, Cannulated, Headless, Medium Thd, 5.5 x 115mm
P26-555-120F	Monster® Beam, Cannulated, Headless, Full Thd, 5.5 x 120mm
P26-555-120M	Monster® Beam, Cannulated, Headless, Medium Thd, 5.5 x 120mm
P26-900-55SL	Beaming, Implant Tray, Ø5.5 Solid, All Thread
P26-755-050F	Monster® Beam, Solid, Headless, Full Thd, 5.5 x 50mm
P26-755-050M	Monster® Beam, Solid, Headless, Medium Thd, 5.5 x 50mm
P26-755-055F	Monster® Beam, Solid, Headless, Full Thd, 5.5 x 55mm
P26-755-055M	Monster® Beam, Solid, Headless, Medium Thd, 5.5 x 55mm
P26-755-060F	Monster® Beam, Solid, Headless, Full Thd, 5.5 x 60mm
P26-755-060M	Monster® Beam, Solid, Headless, Medium Thd, 5.5 x 60mm
P26-755-065F	Monster® Beam, Solid, Headless, Full Thd, 5.5 x 65mm
P26-755-065M	Monster® Beam, Solid, Headless, Medium Thd, 5.5 x 65mm
P26-755-070F	Monster® Beam, Solid, Headless, Full Thd, 5.5 x 70mm
P26-755-070M	Monster® Beam, Solid, Headless, Medium Thd, 5.5 x 70mm
P26-755-075F	Monster® Beam, Solid, Headless, Full Thd, 5.5 x 75mm
P26-755-075M	Monster® Beam, Solid, Headless, Medium Thd, 5.5 x 75mm
P26-755-080F	Monster® Beam, Solid, Headless, Full Thd, 5.5 x 80mm
P26-755-080M	Monster® Beam, Solid, Headless, Medium Thd, 5.5 x 80mm
P26-755-085F	Monster® Beam, Solid, Headless, Full Thd, 5.5 x 85mm

Not all products available for sale in all markets. To determine availability in your marketplace, please contact your local Paragon 28 representative or email info@paragon28.com.

5.0/5.5 JOUST BEAMING SCREWS™

PART NUMBER	DESCRIPTION
P26-755-085M	Monster® Beam, Solid, Headless, Medium Thd, 5.5 x 85mm
P26-755-090F	Monster® Beam, Solid, Headless, Full Thd, 5.5 x 90mm
P26-755-090M	Monster® Beam, Solid, Headless, Medium Thd, 5.5 x 90mm
P26-755-095F	Monster® Beam, Solid, Headless, Full Thd, 5.5 x 95mm
P26-755-095M	Monster® Beam, Solid, Headless, Medium Thd, 5.5 x 95mm
P26-755-100F	Monster® Beam, Solid, Headless, Full Thd, 5.5 x 100mm
P26-755-100M	Monster® Beam, Solid, Headless, Medium Thd, 5.5 x 100mm
P26-755-105F	Monster® Beam, Solid, Headless, Full Thd, 5.5 x 105mm
P26-755-105M	Monster® Beam, Solid, Headless, Medium Thd, 5.5 x 105mm
P26-755-110F	Monster® Beam, Solid, Headless, Full Thd, 5.5 x 110mm
P26-755-110M	Monster® Beam, Solid, Headless, Medium Thd, 5.5 x 110mm
P26-755-115F	Monster® Beam, Solid, Headless, Full Thd, 5.5 x 115mm
P26-755-115M	Monster® Beam, Solid, Headless, Medium Thd, 5.5 x 115mm
P26-755-120F	Monster® Beam, Solid, Headless, Full Thd, 5.5 x 120mm
P26-755-120M	Monster® Beam, Solid, Headless, Medium Thd, 5.5 x 120mm

Not all products available for sale in all markets. To determine availability in your marketplace, please contact your local Paragon 28 representative or email info@paragon28.com.



7.2 Partially and Fully Threaded Beams

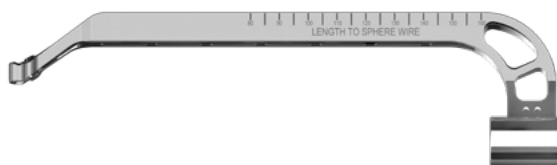

Compression Clamp/Reduction Tube

7.2 JOUST BEAMING SCREWS™

PART NUMBER	DESCRIPTION
P26-900-IMPB	Monster® Beam, Implant Case Base
P26-900-72CP	Beaming, Implant Tray, Ø7.2 Cannulated, Partially Threaded
P26-572-065M	Monster® Beam, Cannulated, Headless, Medium Thd, 7.2 x 65mm
P26-572-070M	Monster® Beam, Cannulated, Headless, Medium Thd, 7.2 x 70mm
P26-572-075M	Monster® Beam, Cannulated, Headless, Medium Thd, 7.2 x 75mm
P26-572-080M	Monster® Beam, Cannulated, Headless, Medium Thd, 7.2 x 80mm
P26-572-085M	Monster® Beam, Cannulated, Headless, Medium Thd, 7.2 x 85mm
P26-572-090M	Monster® Beam, Cannulated, Headless, Medium Thd, 7.2 x 90mm
P26-572-095M	Monster® Beam, Cannulated, Headless, Medium Thd, 7.2 x 95mm
P26-572-100M	Monster® Beam, Cannulated, Headless, Medium Thd, 7.2 x 100mm
P26-572-105M	Monster® Beam, Cannulated, Headless, Medium Thd, 7.2 x 105mm
P26-572-110M	Monster® Beam, Cannulated, Headless, Medium Thd, 7.2 x 110mm
P26-572-115M	Monster® Beam, Cannulated, Headless, Medium Thd, 7.2 x 115mm
P26-572-120M	Monster® Beam, Cannulated, Headless, Medium Thd, 7.2 x 120mm
P26-572-125M	Monster® Beam, Cannulated, Headless, Medium Thd, 7.2 x 125mm
P26-572-130M	Monster® Beam, Cannulated, Headless, Medium Thd, 7.2 x 130mm
P26-572-135M	Monster® Beam, Cannulated, Headless, Medium Thd, 7.2 x 135mm
P26-572-140M	Monster® Beam, Cannulated, Headless, Medium Thd, 7.2 x 140mm
P26-572-145M	Monster® Beam, Cannulated, Headless, Medium Thd, 7.2 x 145mm
P26-572-150M	Monster® Beam, Cannulated, Headless, Medium Thd, 7.2 x 150mm
P26-572-155M	Monster® Beam, Cannulated, Headless, Medium Thd, 7.2 x 155mm
P26-572-160M	Monster® Beam, Cannulated, Headless, Medium Thd, 7.2 x 160mm
P26-572-165M	Monster® Beam, Cannulated, Headless, Medium Thd, 7.2 x 165mm
P26-572-170M	Monster® Beam, Cannulated, Headless, Medium Thd, 7.2 x 170mm
P26-572-175M	Monster® Beam, Cannulated, Headless, Medium Thd, 7.2 x 175mm
P26-572-180M	Monster® Beam, Cannulated, Headless, Medium Thd, 7.2 x 180mm
P26-572-185M	Monster® Beam, Cannulated, Headless, Medium Thd, 7.2 x 185mm
P26-900-72CF	Beaming, Implant Tray, Ø7.2 Cannulated, Fully Threaded
P26-572-065F	Monster® Beam, Cannulated, Headless, Full Thd, 7.2 x 65mm
P26-572-070F	Monster® Beam, Cannulated, Headless, Full Thd, 7.2 x 70mm

Not all products available for sale in all markets. To determine availability in your marketplace, please contact your local Paragon 28 representative or email info@paragon28.com.

7.2 JOUST BEAMING SCREWS™

PART NUMBER	DESCRIPTION
P26-572-075F	Monster® Beam, Cannulated, Headless, Full Thd, 7.2 x 75mm
P26-572-080F	Monster® Beam, Cannulated, Headless, Full Thd, 7.2 x 80mm
P26-572-085F	Monster® Beam, Cannulated, Headless, Full Thd, 7.2 x 85mm
P26-572-090F	Monster® Beam, Cannulated, Headless, Full Thd, 7.2 x 90mm
P26-572-095F	Monster® Beam, Cannulated, Headless, Full Thd, 7.2 x 95mm
P26-572-100F	Monster® Beam, Cannulated, Headless, Full Thd, 7.2 x 100mm
P26-572-105F	Monster® Beam, Cannulated, Headless, Full Thd, 7.2 x 105mm
P26-572-110F	Monster® Beam, Cannulated, Headless, Full Thd, 7.2 x 110mm
P26-572-115F	Monster® Beam, Cannulated, Headless, Full Thd, 7.2 x 115mm
P26-572-120F	Monster® Beam, Cannulated, Headless, Full Thd, 7.2 x 120mm
P26-572-125F	Monster® Beam, Cannulated, Headless, Full Thd, 7.2 x 125mm
P26-572-130F	Monster® Beam, Cannulated, Headless, Full Thd, 7.2 x 130mm
P26-572-135F	Monster® Beam, Cannulated, Headless, Full Thd, 7.2 x 135mm
P26-572-140F	Monster® Beam, Cannulated, Headless, Full Thd, 7.2 x 140mm
P26-572-145F	Monster® Beam, Cannulated, Headless, Full Thd, 7.2 x 145mm
P26-572-150F	Monster® Beam, Cannulated, Headless, Full Thd, 7.2 x 150mm
P26-572-155F	Monster® Beam, Cannulated, Headless, Full Thd, 7.2 x 155mm
P26-572-160F	Monster® Beam, Cannulated, Headless, Full Thd, 7.2 x 160mm
P26-572-165F	Monster® Beam, Cannulated, Headless, Full Thd, 7.2 x 165mm
P26-572-170F	Monster® Beam, Cannulated, Headless, Full Thd, 7.2 x 170mm
P26-572-175F	Monster® Beam, Cannulated, Headless, Full Thd, 7.2 x 175mm
P26-572-180F	Monster® Beam, Cannulated, Headless, Full Thd, 7.2 x 180mm
P26-572-185F	Monster® Beam, Cannulated, Headless, Full Thd, 7.2 x 185mm
P26-900-72SP	Beaming, Implant Tray, Ø7.2 Solid, Partially Threaded
P26-772-065M	Monster® Beam, Solid, Headless, Medium Thd, 7.2 x 65mm
P26-772-070M	Monster® Beam, Solid, Headless, Medium Thd, 7.2 x 70mm
P26-772-075M	Monster® Beam, Solid, Headless, Medium Thd, 7.2 x 75mm
P26-772-080M	Monster® Beam, Solid, Headless, Medium Thd, 7.2 x 80mm
P26-772-085M	Monster® Beam, Solid, Headless, Medium Thd, 7.2 x 85mm
P26-772-090M	Monster® Beam, Solid, Headless, Medium Thd, 7.2 x 90mm
P26-772-095M	Monster® Beam, Solid, Headless, Medium Thd, 7.2 x 95mm
P26-772-100M	Monster® Beam, Solid, Headless, Medium Thd, 7.2 x 100mm
P26-772-105M	Monster® Beam, Solid, Headless, Medium Thd, 7.2 x 105mm
P26-772-110M	Monster® Beam, Solid, Headless, Medium Thd, 7.2 x 110mm
P26-772-115M	Monster® Beam, Solid, Headless, Medium Thd, 7.2 x 115mm
P26-772-120M	Monster® Beam, Solid, Headless, Medium Thd, 7.2 x 120mm
P26-772-125M	Monster® Beam, Solid, Headless, Medium Thd, 7.2 x 125mm
P26-772-130M	Monster® Beam, Solid, Headless, Medium Thd, 7.2 x 130mm
P26-772-135M	Monster® Beam, Solid, Headless, Medium Thd, 7.2 x 135mm
P26-772-140M	Monster® Beam, Solid, Headless, Medium Thd, 7.2 x 140mm

Not all products available for sale in all markets. To determine availability in your marketplace, please contact your local Paragon 28 representative or email info@paragon28.com.

7.2 JOUST BEAMING SCREWS™

PART NUMBER	DESCRIPTION
P26-772-145M	Monster® Beam, Solid, Headless, Medium Thd, 7.2 x 145mm
P26-772-150M	Monster® Beam, Solid, Headless, Medium Thd, 7.2 x 150mm
P26-772-155M	Monster® Beam, Solid, Headless, Medium Thd, 7.2 x 155mm
P26-772-160M	Monster® Beam, Solid, Headless, Medium Thd, 7.2 x 160mm
P26-772-165M	Monster® Beam, Solid, Headless, Medium Thd, 7.2 x 165mm
P26-772-170M	Monster® Beam, Solid, Headless, Medium Thd, 7.2 x 170mm
P26-772-175M	Monster® Beam, Solid, Headless, Medium Thd, 7.2 x 175mm
P26-772-180M	Monster® Beam, Solid, Headless, Medium Thd, 7.2 x 180mm
P26-772-185M	Monster® Beam, Solid, Headless, Medium Thd, 7.2 x 185mm
P26-900-72SF	Beaming, Implant Tray, Ø7.2 Solid, Fully Threaded
P26-772-065F	Monster® Beam, Solid, Headless, Full Thd, 7.2 x 65mm
P26-772-070F	Monster® Beam, Solid, Headless, Full Thd, 7.2 x 70mm
P26-772-075F	Monster® Beam, Solid, Headless, Full Thd, 7.2 x 75mm
P26-772-080F	Monster® Beam, Solid, Headless, Full Thd, 7.2 x 80mm
P26-772-085F	Monster® Beam, Solid, Headless, Full Thd, 7.2 x 85mm
P26-772-090F	Monster® Beam, Solid, Headless, Full Thd, 7.2 x 90mm
P26-772-095F	Monster® Beam, Solid, Headless, Full Thd, 7.2 x 95mm
P26-772-100F	Monster® Beam, Solid, Headless, Full Thd, 7.2 x 100mm
P26-772-105F	Monster® Beam, Solid, Headless, Full Thd, 7.2 x 105mm
P26-772-110F	Monster® Beam, Solid, Headless, Full Thd, 7.2 x 110mm
P26-772-115F	Monster® Beam, Solid, Headless, Full Thd, 7.2 x 115mm
P26-772-120F	Monster® Beam, Solid, Headless, Full Thd, 7.2 x 120mm
P26-772-125F	Monster® Beam, Solid, Headless, Full Thd, 7.2 x 125mm
P26-772-130F	Monster® Beam, Solid, Headless, Full Thd, 7.2 x 130mm
P26-772-135F	Monster® Beam, Solid, Headless, Full Thd, 7.2 x 135mm
P26-772-140F	Monster® Beam, Solid, Headless, Full Thd, 7.2 x 140mm
P26-772-145F	Monster® Beam, Solid, Headless, Full Thd, 7.2 x 145mm
P26-772-150F	Monster® Beam, Solid, Headless, Full Thd, 7.2 x 150mm
P26-772-155F	Monster® Beam, Solid, Headless, Full Thd, 7.2 x 155mm
P26-772-160F	Monster® Beam, Solid, Headless, Full Thd, 7.2 x 160mm
P26-772-165F	Monster® Beam, Solid, Headless, Full Thd, 7.2 x 165mm
P26-772-170F	Monster® Beam, Solid, Headless, Full Thd, 7.2 x 170mm
P26-772-175F	Monster® Beam, Solid, Headless, Full Thd, 7.2 x 175mm
P26-772-180F	Monster® Beam, Solid, Headless, Full Thd, 7.2 x 180mm
P26-772-185F	Monster® Beam, Solid, Headless, Full Thd, 7.2 x 185mm

Not all products available for sale in all markets. To determine availability in your marketplace, please contact your local Paragon 28 representative or email info@paragon28.com.

JOUST™ BEAMING INSTRUMENTS

PART NUMBER	DESCRIPTION
P26-900-INSK	Monster® Beam, K-Wire Tray
P26-900-INSB	Monster® Beam, Instrument Case Base
P26-900-INSL	Monster® Beam, Case Lid
P26-900-INST	Monster® Beam, Instrument Tray
P20-915-5000	Countersink, Ø5.0mm, Headless, SS
P20-915-5500	Countersink, Ø5.5mm, Headless, SS
P20-915-7200	Countersink, Ø7.2mm x 200mm, Headless, SS
P20-930-7000	Tissue Protectors, Universal, SS
P20-931-7000	Drill Guide Ø7.0mm, SS
P20-932-5000	K-Wire Guide, Ø5.0, SS
P20-932-5500	K-Wire Guide, Ø5.5, SS
P20-932-7000	K-Wire Guide, Ø7.0, SS
P20-940-5055	Double Ended Drill Guide, Ø5.0mm & Ø5.5mm, SS
P26-920-5000	Single Lead Tap, Ø5.0mm, Beaming, SS
P26-920-5500	Single Lead Tap, Ø5.5mm, Beaming, SS
P26-951-5055	Depth Gauge, K-Wire Measuring, Lateral Column, SS
P26-951-7200	Depth Gauge, K-Wire Measuring, Medial Column, SS
P51-950-0003	Gorilla, Precision Guide, Straddle, Thrd Knob, SS
P51-950-0005	Gorilla, Precision Guide, Straddle, Adjustment Thrd Knob, SS
P51-950-1109-1	Gorilla, Precision Guide, Straddle, Guide Jig, U Config, SS
P99-000-316A	P28, Jacobs Adapter, 3/16 Sq, Cannulated, SS
P99-000-316L	P28, Handle, 3/16" Sq, Cannulated, Ratcheting, Large
P99-000-316T	P28, T-Handle, 3/16" Sq, Cannulated, Ratcheting
P99-110-3320	P28, Drill, 3.3 x 200 mm, Cannulated, 3/16 Sq, SS
P99-110-3520	P28, Drill, 3.5 x 200 mm, Cannulated, 3/16 Sq, SS
P99-110-4625	P28, Drill, 4.6 x 250 mm, Standard, Cannulated, 3/16 Sq, SS
P99-110-4634	P28, Drill, 4.6 x 340 mm, Long, Cannulated, 3/16 Sq, SS
P99-150-0001	P28, Screw Forceps, Ti
P99-150-0005	P28, K-Wire Ruler
P99-190-TX20	P28, Driver, TX-20, Cannulated, SS
P99-190-TX25	P28, Driver, TX-25, Cannulated, SS
P99-190-TX30	P28, Driver, TX-30, Cannulated, SS
P99-190-TX30-17	P28, Driver, TX-30, Long, Cannulated, SS
P99-192-1423	P28, K-Wire, 1.4 x 230 mm, Single Trocar, Smooth, SS
P99-192-1615	P28, K-Wire, 1.6 x 150 mm, Single Trocar, Smooth, SS
P99-192-1623	P28, K-Wire, 1.6 x 230 mm, Single Trocar, Smooth, SS
P99-192-2323	P28, K-Wire, 2.3 x 230 mm, Single Trocar, Smooth, SS
P99-192-2330	P28, K-Wire, 2.3 x 300 mm, Single Trocar, Smooth, SS
P99-193-1423	P28, K-Wire, 1.4 x 230 mm, Single Trocar, Threaded, SS
P99-193-1623	P28, K-Wire, 1.6 x 230 mm, Single Trocar, Threaded, SS

Not all products available for sale in all markets. To determine availability in your marketplace, please contact your local Paragon 28 representative or email info@paragon28.com.

JOUST™ BEAMING INSTRUMENTS

PART NUMBER	DESCRIPTION
P99-193-2323	P28, K-Wire, 2.3 x 230 mm, Single Trocar, Threaded, SS
P99-193-2330	P28, K-Wire, 2.3 x 300 mm, Single Trocar, Threaded, SS
P99-251-2007	Full Olive Wire, Threaded, 2.0mm x 72mm
P99-900-1005	P28, Instrument, FootPlate
P99-998-1424	1.4mm x 240mm Cleaning Stylet
P99-998-2335	2.3mm x 350mm Cleaning Stylet
P26-900-RXDB	Monster, Beam, Reduction Caddy Base
P26-900-RXDI	Monster, Beam, Reduction Caddy, Insert
P26-900-RXDL	Monster, Beam, Reduction Caddy, Lid
P26-901-0002	Joust, Reduction Guide, Arm
P26-901-0003	Joust, Reduction Guide, Tube
P26-901-0004	Joust, Reduction Guide, Tommy Bar
P26-901-0014	Joust, 1.4mm K-Wire Guide Tube
P26-901-0016	Joust, 1.6mm K-Wire Guide Tube
P26-901-0023	Joust, 2.3mm K-Wire Guide Tube
P26-901-0046	Joust, 4.6mm Drill Guide Tube
P26-901-SMCP	Joust, Reduction Guide, Small Cap
P26-901-LGCP	Joust Reduction Guide, Large Cap
P99-192-2015	Ø2.00mm x 150mm, K-Wire

Section 11:
**JAWS™ STAPLE
SYSTEM**

Not all products available for sale in all markets. To determine availability in your marketplace, please contact your local Paragon 28 representative or email info@paragon28.com.

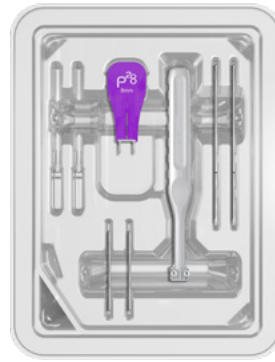
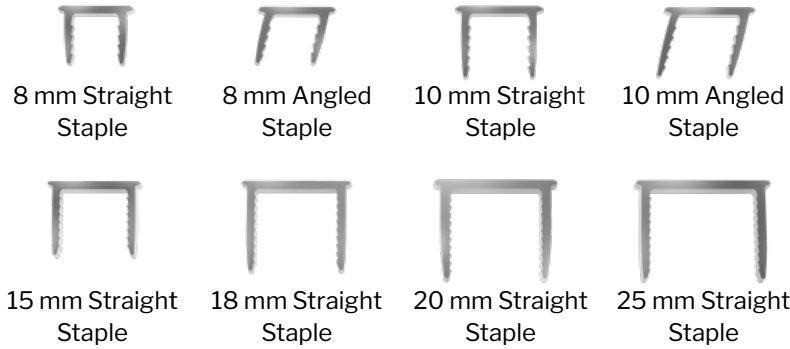

8 mm or 10 mm Staple Kit



15 mm, 18 mm, 20 mm or 25 mm Staple Kit

JAWS™ STAPLES

PART NUMBER	DESCRIPTION
P71-108-0808-S	Angled Staple Assembly, 8 X 8mm
P71-110-1010-S	Angled Staple Assembly, 10 X 10mm
P71-008-0808-S	Straight Staple Assembly, 8 X 8mm
P71-010-1010-S	Straight Staple Assembly, 10 X 10mm
P71-015-1515-S	Straight Staple Assembly, 15 X 15mm
P71-018-1818-S	Straight Staple Assembly, 18 X 18mm
P71-020-2020-S	Straight Staple Assembly, 20 X 20mm
P71-025-2020-S	Straight Staple Assembly, 25 X 20mm
P71-025-2525-S	Straight Staple Assembly, 25 X 25mm

JAWS™ INSTRUMENTS

PART NUMBER	DESCRIPTION
P70-900-JAWS	JAWS Nitinol Staple System, Instrument Caddy, Base
P70-900-JAWS-1	JAWS Nitinol Staple System, Instrument Caddy, Lid
P70-921-0810	JAWS Nitinol Staple System, 8mm and 10mm Trial Sizer
P70-921-1518	JAWS Nitinol Staple System, 15mm and 18mm Trial Sizer
P70-921-2025	JAWS Nitinol Staple System, 20mm and 25mm Trial Sizer
P99-150-0034	Honey Badger, Cartilage Removal Tool
P99-150-0040	Osteotome, Straight, 6mm
P99-150-0041	Osteotome, Straight, 12mm
P99-150-0042	Osteotome, Straight, 19mm
P99-150-0140	Osteotome, Curved, 6mm
P99-150-0141	Osteotome, Curved, 12mm
P99-150-0142	Osteotome, Curved, 19mm
P99-150-0089	Compressor
P99-192-1615	K-Wire, Single Ended Trocar Tip, SMOOTH, 1.6 x 150mm
P99-192-2015	K-Wire, Single Ended Trocar Tip, SMOOTH, 2.0 x 150mm

[BACK TO TABLE OF CONTENTS](#)

Section 12:
GRAPPLER®
INTERFERENCE SCREW
SYSTEM

Not all products available for sale in all markets. To determine availability in your marketplace, please contact your local Paragon 28 representative or email info@paragon28.com.

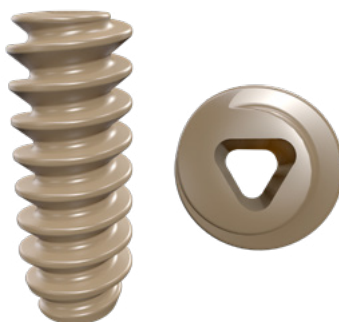

Grappler® Interference Screws

GRAPPLER® INTERFERENCE SCREWS

PART NUMBER	DESCRIPTION
P41-040-1000-S	PEEK Interference Screw Ø4 mm x 10 mm
P41-040-1500-S	PEEK Interference Screw Ø4 mm x 15 mm
P41-040-2000-S	PEEK Interference Screw Ø4 mm x 20 mm
P41-045-1000-S	PEEK Interference Screw Ø4.5 mm x 10 mm
P41-045-1500-S	PEEK Interference Screw Ø4.5 mm x 15 mm
P41-045-2000-S	PEEK Interference Screw Ø4.5 mm x 20 mm
P41-050-1000-S	PEEK Interference Screw Ø5 mm x 10 mm
P41-050-1500-S	PEEK Interference Screw Ø5 mm x 15 mm
P41-050-2000-S	PEEK Interference Screw Ø5 mm x 20 mm
P41-050-2500-S	PEEK Interference Screw Ø5 mm x 25 mm
P41-055-1500-S	PEEK Interference Screw Ø5.5 mm x 15 mm
P41-055-2000-S	PEEK Interference Screw Ø5.5 mm x 20 mm
P41-055-2500-S	PEEK Interference Screw Ø5.5 mm x 25 mm
P41-060-1500-S	PEEK Interference Screw Ø6 mm x 15 mm
P41-060-2000-S	PEEK Interference Screw Ø6 mm x 20 mm
P41-060-2500-S	PEEK Interference Screw Ø6 mm x 25 mm
P41-070-2000-S	PEEK Interference Screw Ø7 mm x 20 mm
P41-070-2500-S	PEEK Interference Screw Ø7 mm x 25 mm
P41-080-2000-S	PEEK Interference Screw Ø8 mm x 20 mm
P41-080-2500-S	PEEK Interference Screw Ø8 mm x 25 mm

Not all products available for sale in all markets. To determine availability in your marketplace, please contact your local Paragon 28 representative or email info@paragon28.com.

GRAPPLER® INTERFERENCE SCREW INSTRUMENTATION

PART NUMBER	DESCRIPTION
P41-910-4013	4.0 Cannulated Drill w/ Depth Markings
P41-910-4513	4.5 Cannulated Drill w/ Depth Markings
P41-910-5015	5.0 Cannulated Drill w/ Depth Markings
P41-910-5513	5.5 Cannulated Drill w/ Depth Markings
P41-910-6013	6.0 Cannulated Drill w/ Depth Markings
P41-910-6513	6.5 Cannulated Drill w/ Depth Markings
P41-910-7013	7.0 Cannulated Drill w/ Depth Markings
P41-910-7513	7.5 Cannulated Drill w/ Depth Markings
P41-910-8013	8.0 Cannulated drill w/ Depth Markings
P41-910-8513	8.5 Cannulated Drill w/ Depth Markings
P41-920-0001	Tendon Sizer
P41-930-0001	Tissue Protector Handle
P41-930-4000	Tissue Protector Insert 4.0
P41-930-4500	Tissue Protector Insert 4.5
P41-930-5000	Tissue Protector Insert 5.0
P41-930-5500	Tissue Protector Insert 5.5
P41-930-6000	Tissue Protector Insert 6.0
P41-930-6500	Tissue Protector Insert 6.5
P41-930-7000	Tissue Protector Insert 7.0
P41-930-7500	Tissue Protector Insert 7.5
P41-930-8000	Tissue Protector Insert 8.0
P41-930-8500	Tissue Protector Insert 8.5
P41-940-3040	4.0 Driver, Solid
P41-940-4550	4.5/5.0 Driver, Solid
P41-940-5560	5.5/6.0 Driver, Solid
P41-940-7080	7.0/8.0 Driver, Solid
P41-950-0025	GRAPPLER™ Depth Gauge, 25mm
P41-960-0020	Through-Hole Suture Loop Guide Rod w/ Nitinol Loop
P99-000-AORP	PALM Ratcheting Driver Handle w/ AO Connect
P99-000-316A	3/16" Square/Jacobs Adapter
P99-192-1620	Ø1.6 x 200mm K-Wire
P41-900-BASE	Case, GRAPPLER™ Interference Screw System Instruments
P41-900-LID	Case Lid, GRAPPLER™ Interference Screw System
P41-941-4550	Ø4.5/5.0 Driver, Cannulated
P41-941-5560	Ø5.5/6.0 Driver, Cannulated
P41-941-7080	Ø7.0/8.0 Driver, Cannulated
P41-942-4550	Ø4.5/5.0 Driver Sleeve
P41-942-5560	Ø5.5/6.0 Driver Sleeve
P41-942-7080	Ø7.0/8.0 Driver Sleeve

Section 13:

R3LEASE™

STABILIZATION SYSTEM

Not all products available for sale in all markets. To determine availability in your marketplace, please contact your local Paragon 28 representative or email info@paragon28.com.

3.9 mm R3LEASE™ Screw -
17 mm Notch Length

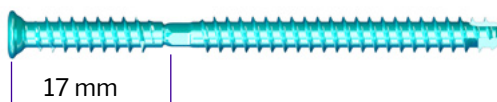

3.9 mm R3LEASE™ Screw -
14 mm Notch Length

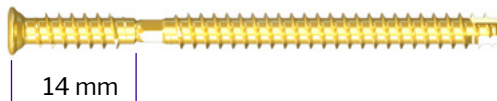

R3LEASE™ STABILIZATION SCREWS AND INSTRUMENTATION

PART NUMBER	DESCRIPTION
P80-900-0002-1	R3LEASE™ Stabilization Device Caddy
P80-900-0002-2	R3LEASE™ Stabilization Device Instrument Caddy
P80-900-0002-3	R3LEASE™ Stabilization Device Caddy Lid
P80-900-0002-4	R3LEASE™ Stabilization Device Instrument Caddy Lid
P50-153-WS00	Screw Flat/Dome Washer, 2.7, 3.5 & 4.2mm
P80-910-2814	Drill, 2.8 x 140mm, Cannulated, AO, R3LEASE™
P80-900-2814	Drill, 2.8 x 140mm, Solid, A/O, R3LEASE™
P80-930-3900	Drill Guide, 3.9mm, R3LEASE™
P80-940-3902	Lateral Removal Driver, R3LEASE™
P80-950-0080	Depth Gauge, Wire Measuring, R3LEASE™
P80-950-0081	Depth Gauge, R3LEASE™
P99-191-TR10	Screw Driver Attachment, Solid, AO, HX-10, Short Taper, R3CON™
P99-192-1615	K-Wire, Single Ended Trocar Tip, SMOOTH, 1.6 x 150mm
P80-239-1440	R3LEASE™ Device, 3.9 X 40mm, 14mm Notch
P80-239-1740	R3LEASE™ Device, 3.9 X 40mm, 17mm Notch
P80-239-1445	R3LEASE™ Device, 3.9 X 45mm, 14mm Notch
P80-239-1745	R3LEASE™ Device, 3.9 X 45mm, 17mm Notch
P80-239-1450	R3LEASE™ Device, 3.9 X 50mm, 14mm Notch
P80-239-1750	R3LEASE™ Device, 3.9 X 50mm, 17mm Notch
P80-239-1452	R3LEASE™ Device, 3.9 X 52mm, 14mm Notch
P80-239-1752	R3LEASE™ Device, 3.9 X 52mm, 17mm Notch
P80-239-1454	R3LEASE™ Device, 3.9 X 54mm, 14mm Notch
P80-239-1754	R3LEASE™ Device, 3.9 X 54mm, 17mm Notch
P80-239-1456	R3LEASE™ Device, 3.9 X 56mm, 14mm Notch
P80-239-1756	R3LEASE™ Device, 3.9 X 56mm, 17mm Notch
P80-239-1458	R3LEASE™ Device, 3.9 X 58mm, 14mm Notch
P80-239-1758	R3LEASE™ Device, 3.9 X 58mm, 17mm Notch
P80-239-1460	R3LEASE™ Device, 3.9 X 60mm, 14mm Notch
P80-239-1760	R3LEASE™ Device, 3.9 X 60mm, 17mm Notch
P80-239-1462	R3LEASE™ Device, 3.9 X 62mm, 14mm Notch

Not all products available for sale in all markets. To determine availability in your marketplace, please contact your local Paragon 28 representative or email info@paragon28.com.

R3LEASE™ STABILIZATION SCREWS AND INSTRUMENTATION

PART NUMBER	DESCRIPTION
P80-239-1762	R3LEASE™ Device, 3.9 X 62mm, 17mm Notch
P80-239-1464	R3LEASE™ Device, 3.9 X 64mm, 14mm Notch
P80-239-1764	R3LEASE™ Device, 3.9 X 64mm, 17mm Notch
P80-239-1466	R3LEASE™ Device, 3.9 X 66mm, 14mm Notch
P80-239-1766	R3LEASE™ Device, 3.9 X 66mm, 17mm Notch

**JUMP TO R3LEASE SCREWS
STERILE PACKAGED PRODUCT**



R3LEASE™ STABILIZATION REMOVAL INSTRUMENTATION

PART NUMBER	DESCRIPTION
P20-900-5005-1	Ø1.2mm K-Wire Tube
P20-900-5006	K-Wire Tube Cap
P80-900-0003-1	Syndesmosis Removal Module
P80-900-0003-2	Syndesmosis Removal Module, Lid
P80-940-3901	Syndesmosis Medial Removal Driver
P80-940-3902	Breakaway Lateral Removal Driver
P80-960-5500	Ø5.5mm OD Breakaway Trepine
P99-100-4212	Over Drill, 4.0 x 110mm, Solid, AO
P99-191-TR10	Gorilla R3CON Driver, Solid, HX10 X 68 MM, SS
P99-192-1210	Ø1.2mm X 100mm K-Wire



Section 14:

TENOTAC® SOFT TISSUE FIXATION SYSTEM

Not all products available for sale in all markets. To determine availability in your marketplace, please contact your local Paragon 28 representative or email info@paragon28.com.



TenoTac® Sterile Kit

TENOTAC® IMPLANTS KITS (STERILE)

PART NUMBER	DESCRIPTION
P42-022-0065-SK	TenoTac® Sterile Kit - Standard
P42-022-0065-S	TenoTac® Male Implant, ø6 mm x 2.2 mm x 6.5 mm Sterile Packaged
P42-122-0050-S	TenoTac® Female Implant, Short, ø4.5 mm x 2.2 mm x 5 mm Sterile Packaged
P42-122-0075-S	TenoTac® Female Implant, Medium, ø4.5 mm x 2.2 mm x 7.5 mm Sterile Packaged
P42-122-0100-S	TenoTac® Female Implant, Long, ø4.5 mm x 2.2 mm x 10 mm Sterile Packaged
P42-122-0125-S	Tenotac® Female implant, Long, 4.5mm x 2.2mm x 12.5mm Sterile packaged
P42-822-0100-SK	Tenotac Sterile Kit - Large
P42-822-0100-S	Tenotac Male implant 8mm x2.2mm x 10mm Sterile Packaged

Not all products available for sale in all markets. To determine availability in your marketplace, please contact your local Paragon 28 representative or email info@paragon28.com.



TenoTac®
Male Implant



TenoTac® Female
Implant (Short)



TenoTac® Female
Implant (Medium)



TenoTac® Female
Implant (Long)

TENOTAC® IMPLANTS AND INSTRUMENTS (NON-STERILE)

PART NUMBER	DESCRIPTION
P42-900-BASE	TenoTac Caddy Base
P42-900-LID	TenoTac Caddy Lid
P42-022-0065	TenoTac Male Implant ø6mm x 2.2mm x 6.5mm Long
P42-122-0050	(Short) TenoTac Female Implant ø4.5mm x 2.2mm x 5mm Long
P42-122-0075	(Medium) TenoTac Female Implant ø4.5mm x 2.2mm x 7.5mm Long
P42-122-0100	(Long) TenoTac Female Implant ø4.5mm x 2.2mm x 10mm Long
P42-917-2820	TenoTac ø2.8mm Cannulated Drill, ø6.0mm Countersink, 20mm Long
P42-901-T154	TenoTac Male Implant Inserter T15 Driver, 40mm Inserter Wire
P42-902-T151	TenoTac Female Implant Driver, T15
P42-951-0001	TenoTac Female Implant Length Gauge
P99-150-0001	P28 Screw Forceps
P99-000-AOSS	P28 Short Streamline Handle, AO Pull Adapter, Cannulated
P99-192-0910	P28 K-Wire Single ended Trocar, Smooth, 0.9mm x 100

Section 15:
**APEX 3D™ TOTAL
ANKLE REPLACEMENT
SYSTEM**

Not all products available for sale in all markets. To determine availability in your marketplace, please contact your local Paragon 28 representative or email info@paragon28.com.

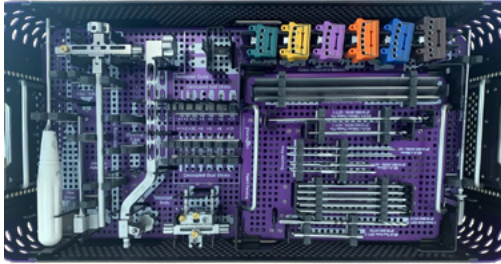

Alignment Tray Top

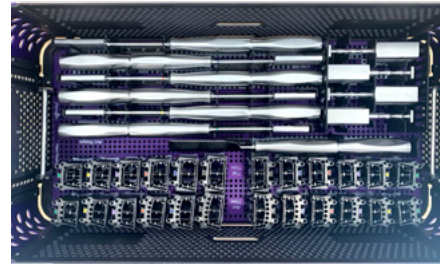

Alignment Tray Bottom

APEX 3D™ ALIGNMENT INSTRUMENTATION

PART NUMBER	DESCRIPTION
P10-900-0001	APEX 3D-PS Total Ankle Replacement System, Alignment, Tray
P10-900-0002	APEX 3D-PS Total Ankle Replacement System, Resection, Tray
P10-900-0007	APEX 3D-PS Total Ankle Replacement System, Small Tray
P10-900-CASB	APEX 3D-PS Total Ankle Replacement System, Case Base
P10-900-CASL	APEX 3D-PS Total Ankle Replacement System, Case Lid
P10-901-24TH	APEX 3D-PS Total Ankle Replacement System, T-Handle
P10-901-OS01	APEX 3D-PS Total Ankle Replacement System, Tibial Osteotome, ARC
P10-901-RGA1	APEX 3D-PS Total Ankle Replacement System, Resection Gap Checker, ARC/Chamfer-Cut
P10-901-RGA2	APEX 3D-PS Total Ankle Replacement System, Resection Gap Checker, ARC/Flat-Cut
P10-901-RGF1	APEX 3D-PS Total Ankle Replacement System, Resection Gap Checker, FLAT/Chamfer-Cut
P10-901-RGF2	APEX 3D-PS Total Ankle Replacement System, Resection Gap Checker, FLAT/Flat-Cut
P10-901-RSP1	APEX 3D-PS Total Ankle Replacement System, Tibial Rasp, ARC, Size 1
P10-901-RSP2	APEX 3D-PS Total Ankle Replacement System, Tibial Rasp, ARC, Size 2
P10-901-RSP3	APEX 3D-PS Total Ankle Replacement System, Tibial Rasp, ARC, Size 3
P10-901-RSP4	APEX 3D-PS Total Ankle Replacement System, Tibial Rasp, ARC, Size 4
P10-901-RSP5	APEX 3D-PS Total Ankle Replacement System, Tibial Rasp, ARC, Size 5
P10-901-RSP6	APEX 3D-PS Total Ankle Replacement System, Tibial Rasp, ARC, Size 6
P10-902-2425	APEX 3D-PS Total Ankle Replacement System, 2.4 Shoulder-Thread Pin, 25mm Thread length
P10-902-2450	APEX 3D-PS Total Ankle Replacement System, 2.4 Shoulder-Thread Pin, 50mm Thread length
P10-902-3010	APEX 3D-PS Total Ankle Replacement System, 3.0 Pin, 316LVM, Fluted, 100mm
P10-902-3016	APEX 3D-PS Total Ankle Replacement System, 3.0 Pin, 316LVM, Fluted, 160mm
P10-910-SCKT	APEX 3D-PS Total Ankle Replacement System, Socket Driver
P10-940-JL01	APEX 3D-PS Total Ankle Replacement System, Joint-Line, Pin-Guide
P10-940-JL10	APEX 3D-PS Total Ankle Replacement System, Joint-Line, Pin Tube
P10-941-AL01	APEX 3D-PS Total Ankle Replacement System, Tibial Alignment Guide, Telescoping Rod
P10-941-AL02	APEX 3D-PS Total Ankle Replacement System, Tibial Alignment Guide, Telescoping Base
P10-941-AL03	APEX 3D-PS Total Ankle Replacement System, Tibial Alignment Guide, Distal Body
P10-941-AL04	APEX 3D-PS Total Ankle Replacement System, Tibial Alignment Guide, Lateral Rod
P10-941-AL05	APEX 3D-PS Total Ankle Replacement System, Tibial Alignment Guide, Fast-Track
P10-941-AL06	APEX 3D-PS Total Ankle Replacement System, Tibial Alignment, Gutter Tool

Not all products available for sale in all markets. To determine availability in your marketplace, please contact your local Paragon 28 representative or email info@paragon28.com.

APEX 3D™ ALIGNMENT INSTRUMENTATION

PART NUMBER	DESCRIPTION
P10-941-AL07	APEX 3D-PS Total Ankle Replacement System, Tibial Alignment Guide, Joint Line Pointer ("JLP")
P10-941-AW01	APEX 3D-PS Total Ankle Replacement System, Tibial Alignment, Joint Line Reference Wing
P10-942-3513	APEX 3D-PS Total Ankle Replacement System, Arc Resection Drill, SS, Ø3.5MM
P10-942-35TH	APEX 3D-PS Total Ankle Replacement System, Top Hat, SS, Ø3.5MM
P10-942-DT01	APEX 3D-PS Total Ankle Replacement System, Decoupled Talar Resection, Shim, 1mm
P10-942-DT02	APEX 3D-PS Total Ankle Replacement System, Decoupled Talar Resection, Shim, 2mm
P10-942-DT03	APEX 3D-PS Total Ankle Replacement System, Decoupled Talar Resection, Shim, 3mm
P10-942-DT04	APEX 3D-PS Total Ankle Replacement System, Decoupled Talar Resection, Shim, 4mm
P10-942-DT05	APEX 3D-PS Total Ankle Replacement System, Decoupled Talar Resection, Shim, 5mm
P10-942-DT06	APEX 3D-PS Total Ankle Replacement System, Decoupled Talar Resection, Shim, 6mm
P10-942-DT07	APEX 3D-PS Total Ankle Replacement System, Decoupled Talar Resection, Shim, 7mm
P10-942-DT11	APEX 3D-PS Total Ankle Replacement System, Decoupled Talar Resection, Split Shim, 1mm
P10-942-DT12	APEX 3D-PS Total Ankle Replacement System, Decoupled Talar Resection, Split Shim, 2mm
P10-942-DT13	APEX 3D-PS Total Ankle Replacement System, Decoupled Talar Resection, Split Shim, 3mm
P10-942-DT14	APEX 3D-PS Total Ankle Replacement System, Decoupled Talar Resection, Split Shim, 4mm
P10-942-DT15	APEX 3D-PS Total Ankle Replacement System, Decoupled Talar Resection, Split Shim, 5mm
P10-942-DT16	APEX 3D-PS Total Ankle Replacement System, Decoupled Talar Resection, Split Shim, 6mm
P10-942-DT17	APEX 3D-PS Total Ankle Replacement System, Decoupled Talar Resection, Split Shim, 7mm
P10-942-DTSM	APEX 3D-PS Total Ankle Replacement System, Decoupled Talar Resection, Body, Small
P10-942-FL01	APEX 3D-PS Total Ankle Replacement System, Coupled Resection Block, FLAT/Chamfer-Cut, Size 1
P10-942-FL02	APEX 3D-PS Total Ankle Replacement System, Coupled Resection Block, FLAT/Chamfer-Cut, Size 2
P10-942-FL03	APEX 3D-PS Total Ankle Replacement System, Coupled Resection Block, FLAT/Chamfer-Cut, Size 3
P10-942-FL04	APEX 3D-PS Total Ankle Replacement System, Coupled Resection Block, FLAT/Chamfer-Cut, Size 4
P10-942-FL05	APEX 3D-PS Total Ankle Replacement System, Coupled Resection Block, FLAT/Chamfer-Cut, Size 5
P10-942-FL06	APEX 3D-PS Total Ankle Replacement System, Coupled Resection Block, FLAT/Chamfer-Cut, Size 6
P10-942-FL11	APEX 3D-PS Total Ankle Replacement System, Coupled Resection Block, FLAT/Flat-Cut, Size 1
P10-942-FL12	APEX 3D-PS Total Ankle Replacement System, Coupled Resection Block, FLAT/Flat-Cut, Size 2
P10-942-FL13	APEX 3D-PS Total Ankle Replacement System, Coupled Resection Block, FLAT/Flat-Cut, Size 3
P10-942-FL14	APEX 3D-PS Total Ankle Replacement System, Coupled Resection Block, FLAT/Flat-Cut, Size 4
P10-942-FL15	APEX 3D-PS Total Ankle Replacement System, Coupled Resection Block, FLAT/Flat-Cut, Size 5
P10-942-FL16	APEX 3D-PS Total Ankle Replacement System, Coupled Resection Block, FLAT/Flat-Cut, Size 6
P10-942-RS01	APEX 3D-PS Total Ankle Replacement System, Coupled Resection Block, ARC/Chamfer-Cut, Size 1
P10-942-RS02	APEX 3D-PS Total Ankle Replacement System, Coupled Resection Block, ARC/Chamfer-Cut, Size 2
P10-942-RS03	APEX 3D-PS Total Ankle Replacement System, Coupled Resection Block, ARC/Chamfer-Cut, Size 3
P10-942-RS04	APEX 3D-PS Total Ankle Replacement System, Coupled Resection Block, ARC/Chamfer-Cut, Size 4
P10-942-RS05	APEX 3D-PS Total Ankle Replacement System, Coupled Resection Block, ARC/Chamfer-Cut, Size 5
P10-942-RS06	APEX 3D-PS Total Ankle Replacement System, Coupled Resection Block, ARC/Chamfer-Cut, Size 6
P10-942-RS11	APEX 3D-PS Total Ankle Replacement System, Coupled Resection Block, ARC/Flat-Cut, Size 1
P10-942-RS12	APEX 3D-PS Total Ankle Replacement System, Coupled Resection Block, ARC/Flat-Cut, Size 2
P10-942-RS13	APEX 3D-PS Total Ankle Replacement System, Coupled Resection Block, ARC/Flat-Cut, Size 3

Not all products available for sale in all markets. To determine availability in your marketplace, please contact your local Paragon 28 representative or email info@paragon28.com.

APEX 3D™ ALIGNMENT INSTRUMENTATION

PART NUMBER	DESCRIPTION
P10-942-RS14	APEX 3D-PS Total Ankle Replacement System, Coupled Resection Block, ARC/Flat-Cut, Size 4
P10-942-RS15	APEX 3D-PS Total Ankle Replacement System, Coupled Resection Block, ARC/Flat-Cut, Size 5
P10-942-RS16	APEX 3D-PS Total Ankle Replacement System, Coupled Resection Block, ARC/Flat-Cut, Size 6
P10-942-SZ01	APEX 3D-PS Total Ankle Replacement System, Sizing Resection Block, Size 1
P10-942-SZ02	APEX 3D-PS Total Ankle Replacement System, Sizing Resection Block, Size 2
P10-942-SZ03	APEX 3D-PS Total Ankle Replacement System, Sizing Resection Block, Size 3
P10-942-SZ04	APEX 3D-PS Total Ankle Replacement System, Sizing Resection Block, Size 4
P10-942-SZ05	APEX 3D-PS Total Ankle Replacement System, Sizing Resection Block, Size 5
P10-942-SZ06	APEX 3D-PS Total Ankle Replacement System, Sizing Resection Block, Size 6
P99-150-0040	Osteotome, Straight, 6mm
P99-150-0041	Osteotome, Straight, 12mm
P99-150-0042	Osteotome, Straight, 19mm
P99-150-HX35	3.5MM Hex Screw Driver, 225mm Length
P99-160-2411	Steinmann Pin, 316LVM, Smooth, Ø2.4x110mm

Not all products available for sale in all markets. To determine availability in your marketplace, please contact your local Paragon 28 representative or email info@paragon28.com.

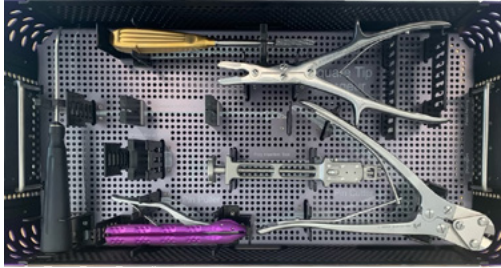

Large Instrument Case Top

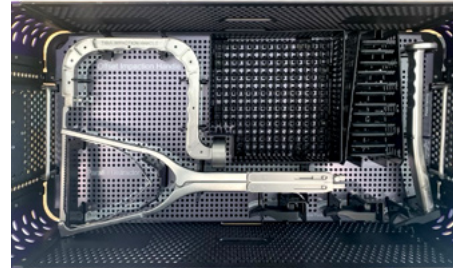

Large Instrument Case Bottom

APEX 3D™ LARGE INSTRUMENT CASE

PART NUMBER	DESCRIPTION
P10-900-0005	APEX 3D-PS Total Ankle Replacement System, Impaction, Tray
P10-900-0006	APEX 3D-PS Total Ankle Replacement System, Large Instrumentation, Tray
P10-900-CASB	APEX 3D-PS Total Ankle Replacement System, Case Base
P10-900-CASL	APEX 3D-PS Total Ankle Replacement System, Case Lid
P10-901-PP24	APEX 3D-PS Total Ankle Replacement System, Pin Puller
P10-944-STRO	APEX 3D-PS Total Ankle Replacement System, Square Tip Ronguer
P10-944-TCR1	APEX 3D-PS Total Ankle Replacement System, 2mm Dorsal, Recut Guide
P10-944-TCR2	APEX 3D-PS Total Ankle Replacement System, Posterior, Recut Guide
P10-951-4BAR	APEX 3D-PS Total Ankle Replacement System, 4-Bar Distractor
P10-951-IN02	APEX 3D-PS Total Ankle Replacement System, Poly Insertion Tool
P10-951-TB00	APEX 3D-PS Total Ankle Replacement System, Tibia Impaction Handle
P10-951-TP01	APEX 3D-PS Total Ankle Replacement System, Tibia Impaction Protector, Size 1
P10-951-TP02	APEX 3D-PS Total Ankle Replacement System, Tibia Impaction Protector, Size 2
P10-951-TP03	APEX 3D-PS Total Ankle Replacement System, Tibia Impaction Protector, Size 3
P10-951-TP04	APEX 3D-PS Total Ankle Replacement System, Tibia Impaction Protector, Size 4
P10-951-TP05	APEX 3D-PS Total Ankle Replacement System, Tibia Impaction Protector, Size 5
P10-951-TP06	APEX 3D-PS Total Ankle Replacement System, Tibia Impaction Protector, Size 6
P10-952-TL00	APEX 3D-PS Total Ankle Replacement System, Talus Impaction Handle
P10-952-TL00-04	Total, Ankle, Instrument, Talus Impactor, Pad
P10-952-TL00-05	APEX 3D-PS Total Ankle, Instrument, Talus Impactor, Socket Head Screw
P99-150-0016	Pin Cutter
P99-150-0105	Rasp, General
P99-150-1341	Osteotome, Solid, Handled, Curved, 6mm

Not all products available for sale in all markets. To determine availability in your marketplace, please contact your local Paragon 28 representative or email info@paragon28.com.

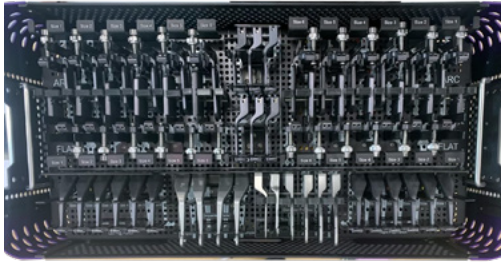

Resection Case Top

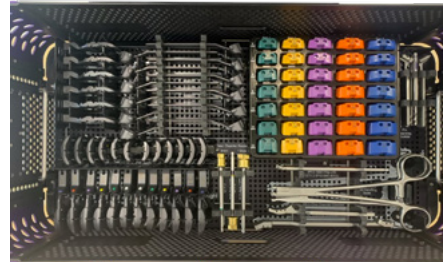

Resection Case Bottom

APEX 3D™ RESECTION CASE

PART NUMBER	DESCRIPTION
P10-900-0003	APEX 3D-PS Total Ankle Replacement System, Tibia Trialing, Tray
P10-900-0004	APEX 3D-PS Total Ankle Replacement System, Talus Trialing, Tray
P10-900-CASB	APEX 3D-PS Total Ankle Replacement System, Case Base
P10-900-CASL	APEX 3D-PS Total Ankle Replacement System, Case Lid
P10-910-TB1L	APEX 3D-PS Total Ankle Replacement System, Trial Tibia, ARC, Size 1, Left
P10-910-TB1R	APEX 3D-PS Total Ankle Replacement System, Trial Tibia, ARC, Size 1, Right
P10-910-TB2L	APEX 3D-PS Total Ankle Replacement System, Trial Tibia, ARC, Size 2, Left
P10-910-TB2R	APEX 3D-PS Total Ankle Replacement System, Trial Tibia, ARC, Size 2, Right
P10-910-TB3L	APEX 3D-PS Total Ankle Replacement System, Trial Tibia, ARC, Size 3, Left
P10-910-TB3R	APEX 3D-PS Total Ankle Replacement System, Trial Tibia, ARC, Size 3, Right
P10-910-TB4L	APEX 3D-PS Total Ankle Replacement System, Trial Tibia, ARC, Size 4, Left
P10-910-TB4R	APEX 3D-PS Total Ankle Replacement System, Trial Tibia, ARC, Size 4, Right
P10-910-TB5L	APEX 3D-PS Total Ankle Replacement System, Trial Tibia, ARC, Size 5, Left
P10-910-TB5R	APEX 3D-PS Total Ankle Replacement System, Trial Tibia, ARC, Size 5, Right
P10-910-TB6L	APEX 3D-PS Total Ankle Replacement System, Trial Tibia, ARC, Size 6, Left
P10-910-TB6R	APEX 3D-PS Total Ankle Replacement System, Trial Tibia, ARC, Size 6, Right
P10-911-TB1L	APEX 3D-PS Total Ankle Replacement System, Trial Tibia, FLAT, Size 1, Left
P10-911-TB1R	APEX 3D-PS Total Ankle Replacement System, Trial Tibia, FLAT, Size 1, Right
P10-911-TB2L	APEX 3D-PS Total Ankle Replacement System, Trial Tibia, FLAT, Size 2, Left
P10-911-TB2R	APEX 3D-PS Total Ankle Replacement System, Trial Tibia, FLAT, Size 2, Right
P10-911-TB3L	APEX 3D-PS Total Ankle Replacement System, Trial Tibia, FLAT, Size 3, Left
P10-911-TB3R	APEX 3D-PS Total Ankle Replacement System, Trial Tibia, FLAT, Size 3, Right
P10-911-TB4L	APEX 3D-PS Total Ankle Replacement System, Trial Tibia, FLAT, Size 4, Left
P10-911-TB4R	APEX 3D-PS Total Ankle Replacement System, Trial Tibia, FLAT, Size 4, Right
P10-911-TB5L	APEX 3D-PS Total Ankle Replacement System, Trial Tibia, FLAT, Size 5, Left
P10-911-TB5R	APEX 3D-PS Total Ankle Replacement System, Trial Tibia, FLAT, Size 5, Right
P10-911-TB6L	APEX 3D-PS Total Ankle Replacement System, Trial Tibia, FLAT, Size 6, Left
P10-911-TB6R	APEX 3D-PS Total Ankle Replacement System, Trial Tibia, FLAT, Size 6, Right
P10-920-TFT0	APEX 3D-PS Total Ankle Replacement System, Talar Fin Tower, Size 1 Narrow & 1
P10-920-TFT2	APEX 3D-PS Total Ankle Replacement System, Talar Fin Tower, Size 2-5

Not all products available for sale in all markets. To determine availability in your marketplace, please contact your local Paragon 28 representative or email info@paragon28.com.

APEX 3D™ RESECTION INSTRUMENTATION

PART NUMBER	DESCRIPTION
P10-920-TLL0	APEX 3D-PS Total Ankle Replacement System, Trial Talus, Chamfer, Size 1 Narrow, Left
P10-920-TLL1	APEX 3D-PS Total Ankle Replacement System, Trial Talus, Chamfer, Size 1, Left
P10-920-TLL2	APEX 3D-PS Total Ankle Replacement System, Trial Talus, Chamfer, Size 2, Left
P10-920-TLL3	APEX 3D-PS Total Ankle Replacement System, Trial Talus, Chamfer, Size 3, Left
P10-920-TLL4	APEX 3D-PS Total Ankle Replacement System, Trial Talus, Chamfer, Size 4, Left
P10-920-TLL5	APEX 3D-PS Total Ankle Replacement System, Trial Talus, Chamfer, Size 5, Left
P10-920-TLR0	APEX 3D-PS Total Ankle Replacement System, Trial Talus, Chamfer, Size 1 Narrow, Right
P10-920-TLR1	APEX 3D-PS Total Ankle Replacement System, Trial Talus, Chamfer, Size 1, Right
P10-920-TLR2	APEX 3D-PS Total Ankle Replacement System, Trial Talus, Chamfer, Size 2, Right
P10-920-TLR3	APEX 3D-PS Total Ankle Replacement System, Trial Talus, Chamfer, Size 3, Right
P10-920-TLR4	APEX 3D-PS Total Ankle Replacement System, Trial Talus, Chamfer, Size 4, Right
P10-920-TLR5	APEX 3D-PS Total Ankle Replacement System, Trial Talus, Chamfer, Size 5, Right
P10-920-TLRM	APEX 3D-PS Total Ankle Replacement System, Talar Fin Sweeper
P10-921-TLL0	APEX 3D-PS Total Ankle Replacement System, Trial Talus, Flat, Size 1 Narrow, Left
P10-921-TLL1	APEX 3D-PS Total Ankle Replacement System, Trial Talus, Flat, Size 1, Left
P10-921-TLL2	APEX 3D-PS Total Ankle Replacement System, Trial Talus, Flat, Size 2, Left
P10-921-TLL3	APEX 3D-PS Total Ankle Replacement System, Trial Talus, Flat, Size 3, Left
P10-921-TLL4	APEX 3D-PS Total Ankle Replacement System, Trial Talus, Flat, Size 4, Left
P10-921-TLL5	APEX 3D-PS Total Ankle Replacement System, Trial Talus, Flat, Size 5, Left
P10-921-TLR0	APEX 3D-PS Total Ankle Replacement System, Trial Talus, Flat, Size 1 Narrow, Right
P10-921-TLR1	APEX 3D-PS Total Ankle Replacement System, Trial Talus, Flat, Size 1, Right
P10-921-TLR2	APEX 3D-PS Total Ankle Replacement System, Trial Talus, Flat, Size 2, Right
P10-921-TLR3	APEX 3D-PS Total Ankle Replacement System, Trial Talus, Flat, Size 3, Right
P10-921-TLR4	APEX 3D-PS Total Ankle Replacement System, Trial Talus, Flat, Size 4, Right
P10-921-TLR5	APEX 3D-PS Total Ankle Replacement System, Trial Talus, Flat, Size 4, Right
P10-930-I106	APEX 3D-PS Total Ankle Replacement System, Poly Trial Insert, Size 1, 6mm
P10-930-I107	APEX 3D-PS Total Ankle Replacement System, Poly Trial Insert, Size 1, 7mm
P10-930-I108	APEX 3D-PS Total Ankle Replacement System, Poly Trial Insert, Size 1, 8mm
P10-930-I109	APEX 3D-PS Total Ankle Replacement System, Poly Trial Insert, Size 1, 9mm
P10-930-I110	APEX 3D-PS Total Ankle Replacement System, Poly Trial Insert, Size 1, 10mm
P10-930-I111	APEX 3D-PS Total Ankle Replacement System, Poly Trial Insert, Size 1, 11mm
P10-930-I112	APEX 3D-PS Total Ankle Replacement System, Poly Trial Insert, Size 1, 12mm
P10-930-I206	APEX 3D-PS Total Ankle Replacement System, Poly Trial Insert, Size 2, 6mm
P10-930-I207	APEX 3D-PS Total Ankle Replacement System, Poly Trial Insert, Size 2, 7mm
P10-930-I208	APEX 3D-PS Total Ankle Replacement System, Poly Trial Insert, Size 2, 8mm
P10-930-I209	APEX 3D-PS Total Ankle Replacement System, Poly Trial Insert, Size 2, 9mm
P10-930-I210	APEX 3D-PS Total Ankle Replacement System, Poly Trial Insert, Size 2, 10mm
P10-930-I211	APEX 3D-PS Total Ankle Replacement System, Poly Trial Insert, Size 2, 11mm
P10-930-I212	APEX 3D-PS Total Ankle Replacement System, Poly Trial Insert, Size 2, 12mm
P10-930-I306	APEX 3D-PS Total Ankle Replacement System, Poly Trial Insert, Size 3, 6mm

Not all products available for sale in all markets. To determine availability in your marketplace, please contact your local Paragon 28 representative or email info@paragon28.com.

APEX 3D™ RESECTION INSTRUMENTATION

PART NUMBER	DESCRIPTION
P10-930-I307	APEX 3D-PS Total Ankle Replacement System, Poly Trial Insert, Size 3, 7mm
P10-930-I308	APEX 3D-PS Total Ankle Replacement System, Poly Trial Insert, Size 3, 8mm
P10-930-I309	APEX 3D-PS Total Ankle Replacement System, Poly Trial Insert, Size 3, 9mm
P10-930-I310	APEX 3D-PS Total Ankle Replacement System, Poly Trial Insert, Size 3, 10mm
P10-930-I311	APEX 3D-PS Total Ankle Replacement System, Poly Trial Insert, Size 3, 11mm
P10-930-I312	APEX 3D-PS Total Ankle Replacement System, Poly Trial Insert, Size 3, 12mm
P10-930-I406	APEX 3D-PS Total Ankle Replacement System, Poly Trial Insert, Size 4, 6mm
P10-930-I407	APEX 3D-PS Total Ankle Replacement System, Poly Trial Insert, Size 4, 7mm
P10-930-I408	APEX 3D-PS Total Ankle Replacement System, Poly Trial Insert, Size 4, 8mm
P10-930-I409	APEX 3D-PS Total Ankle Replacement System, Poly Trial Insert, Size 4, 9mm
P10-930-I410	APEX 3D-PS Total Ankle Replacement System, Poly Trial Insert, Size 4, 10mm
P10-930-I411	APEX 3D-PS Total Ankle Replacement System, Poly Trial Insert, Size 4, 11mm
P10-930-I412	APEX 3D-PS Total Ankle Replacement System, Poly Trial Insert, Size 4, 12mm
P10-930-I506	APEX 3D-PS Total Ankle Replacement System, Poly Trial Insert, Size 5, 6mm
P10-930-I507	APEX 3D-PS Total Ankle Replacement System, Poly Trial Insert, Size 5, 7mm
P10-930-I508	APEX 3D-PS Total Ankle Replacement System, Poly Trial Insert, Size 5, 8mm
P10-930-I509	APEX 3D-PS Total Ankle Replacement System, Poly Trial Insert, Size 5, 9mm
P10-930-I510	APEX 3D-PS Total Ankle Replacement System, Poly Trial Insert, Size 5, 10mm
P10-930-I511	APEX 3D-PS Total Ankle Replacement System, Poly Trial Insert, Size 5, 11mm
P10-930-I512	APEX 3D-PS Total Ankle Replacement System, Poly Trial Insert, Size 5, 12mm
P10-944-0975	APEX 3D-PS Total Ankle Replacement System, Talar Chamfer Resection Router, Ø9mm
P10-944-1175	APEX 3D-PS Total Ankle Replacement System, Talar Chamfer Resection Router, Ø11mm
P10-944-1375	APEX 3D-PS Total Ankle Replacement System, Talar Chamfer Resection Router, Ø13mm
P10-944-4013	APEX 3D-PS Total Ankle Replacement System, Talar Peg Router
P10-944-LL00	APEX 3D-PS Total Ankle Replacement System, Talar Sizing Resection Guide, Chamfer, Size 1 Narrow
P10-944-LL01	APEX 3D-PS Total Ankle Replacement System, Talar Sizing Resection Guide, Chamfer, Size 1
P10-944-LL02	APEX 3D-PS Total Ankle Replacement System, Talar Sizing Resection Guide, Chamfer, Size 2
P10-944-LL03	APEX 3D-PS Total Ankle Replacement System, Talar Sizing Resection Guide, Chamfer, Size 3
P10-944-LL04	APEX 3D-PS Total Ankle Replacement System, Talar Sizing Resection Guide, Chamfer, Size 4
P10-944-LL05	APEX 3D-PS Total Ankle Replacement System, Talar Sizing Resection Guide, Chamfer, Size 5
P10-944-LL10	APEX 3D-PS Total Ankle Replacement System, Anterior Chamfer Resection Insert, Single-Slotted, Size 1 Narrow
P10-944-LL11	APEX 3D-PS Total Ankle Replacement System, Anterior Chamfer Resection Insert, Single-Slotted, Size 1
P10-944-LL12	APEX 3D-PS Total Ankle Replacement System, Anterior Chamfer Resection Insert, Single-Slotted, Size 2
P10-944-LL13	APEX 3D-PS Total Ankle Replacement System, Anterior Chamfer Resection Insert, Single-Slotted, Size 3
P10-944-LL14	APEX 3D-PS Total Ankle Replacement System, Anterior Chamfer Resection Insert, Single-Slotted, Size 4
P10-944-LL15	APEX 3D-PS Total Ankle Replacement System, Anterior Chamfer Resection Insert, Single-Slotted, Size 5
P10-944-LL20	APEX 3D-PS Total Ankle Replacement System, Anterior Chamfer Resection Insert, 2-Holed, Size 1 Narrow
P10-944-LL21	APEX 3D-PS Total Ankle Replacement System, Anterior Chamfer Resection Insert, 2-Holed, Size 1
P10-944-LL22	APEX 3D-PS Total Ankle Replacement System, Anterior Chamfer Resection Insert, 2-Holed, Size 2
P10-944-LL23	APEX 3D-PS Total Ankle Replacement System, Anterior Chamfer Resection Insert, 2-Holed, Size 3

Not all products available for sale in all markets. To determine availability in your marketplace, please contact your local Paragon 28 representative or email info@paragon28.com.

APEX 3D™ RESECTION INSTRUMENTATION

PART NUMBER	DESCRIPTION
P10-944-LL24	APEX 3D-PS Total Ankle Replacement System, Anterior Chamfer Resection Insert, 2-Holed, Size 4
P10-944-LL25	APEX 3D-PS Total Ankle Replacement System, Anterior Chamfer Resection Insert, 2-Holed, Size 5
P10-944-TCC1	APEX 3D-PS Total Ankle Replacement System, Chamfer Checker, All-in-one, SS
P10-944-TCC2	APEX 3D-PS Total Ankle Replacement System, Chamfer Checker, AP Double-Ended, SS
P10-951-P001	APEX 3D-PS Total Ankle Replacement System, 4-Bar Distractor, Tibia Paddle, Constrained
P10-951-P002	APEX 3D-PS Total Ankle Replacement System, 4-Bar Distractor, Tibia Paddle, A-P Translation
P10-951-P011	APEX 3D-PS Total Ankle Replacement System, 4-Bar Distractor, Talus Paddle, Size 1 Narrow & 1
P10-951-P012	APEX 3D-PS Total Ankle Replacement System, 4-Bar Distractor, Talus Paddle, Size 2 & 3
P10-951-P013	APEX 3D-PS Total Ankle Replacement System, 4-Bar Distractor, Talus Paddle, Size 4 & 5
P10-951-P021	APEX 3D-PS Total Ankle Replacement System, 4-Bar Distractor, Tibia Implantation Paddle
P10-951-TBL1	APEX 3D-PS Total Ankle Replacement System, Tibia Impaction Dimple, Left
P10-951-TBL2	APEX 3D-PS Total Ankle Replacement System, Tibia Impaction Coin, Left
P10-951-TBR1	APEX 3D-PS Total Ankle Replacement System, Tibia Impaction Dimple, Right
P10-951-TBR2	APEX 3D-PS Total Ankle Replacement System, Tibia Impaction Coin, Right
P10-951-TBV1	APEX 3D-PS Total Ankle Replacement System, 4-Bar Distractor, Viper Tip, Size 1, SS
P10-951-TBV2	APEX 3D-PS Total Ankle Replacement System, 4-Bar Distractor, Viper Tip, Size 2, SS
P10-951-TBV3	APEX 3D-PS Total Ankle Replacement System, 4-Bar Distractor, Viper Tip, Size 3, SS
P10-951-TBV4	APEX 3D-PS Total Ankle Replacement System, 4-Bar Distractor, Viper Tip, Size 4, SS
P10-951-TBV5	APEX 3D-PS Total Ankle Replacement System, 4-Bar Distractor, Viper Tip, Size 5, SS
P10-951-TBV6	APEX 3D-PS Total Ankle Replacement System, 4-Bar Distractor, Viper Tip, Size 6, SS
P10-951-TPL1	APEX 3D-PS Total Ankle Replacement System, Tibia Impaction Peg Punch, Left, Size 1
P10-951-TPL2	APEX 3D-PS Total Ankle Replacement System, Tibia Impaction Peg Punch, Left, Size 2
P10-951-TPL3	APEX 3D-PS Total Ankle Replacement System, Tibia Impaction Peg Punch, Left, Size 3
P10-951-TPL4	APEX 3D-PS Total Ankle Replacement System, Tibia Impaction Peg Punch, Left, Size 4
P10-951-TPL5	APEX 3D-PS Total Ankle Replacement System, Tibia Impaction Peg Punch, Left, Size 5
P10-951-TPL6	APEX 3D-PS Total Ankle Replacement System, Tibia Impaction Peg Punch, Left, Size 6
P10-951-TPR1	APEX 3D-PS Total Ankle Replacement System, Tibia Impaction Peg Punch, Right, Size 1
P10-951-TPR2	APEX 3D-PS Total Ankle Replacement System, Tibia Impaction Peg Punch, Right, Size 2
P10-951-TPR3	APEX 3D-PS Total Ankle Replacement System, Tibia Impaction Peg Punch, Right, Size 3
P10-951-TPR4	APEX 3D-PS Total Ankle Replacement System, Tibia Impaction Peg Punch, Right, Size 4
P10-951-TPR5	APEX 3D-PS Total Ankle Replacement System, Tibia Impaction Peg Punch, Right, Size 5
P10-951-TPR6	APEX 3D-PS Total Ankle Replacement System, Tibia Impaction Peg Punch, Right, Size 6
P10-953-IN01	APEX 3D-PS Total Ankle Replacement System, Poly Trial Handling Tool
P10-953-TL01	APEX 3D-PS Total Ankle Replacement System, Talus Trial Handling Tool

Not all products available for sale in all markets. To determine availability in your marketplace, please contact your local Paragon 28 representative or email info@paragon28.com.

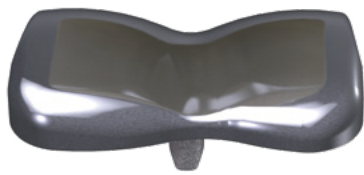

Chamfer Talus Implants

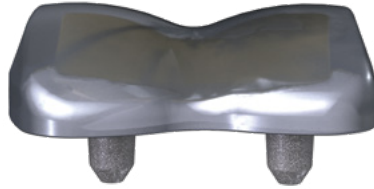

Flat Talus Implants



ARC Tibia™ Implants



FLAT Tibia Implants



APEX 3D™ Cross-linked
Vitamin E POLY

APEX 3D™ IMPLANTS

PART NUMBER	DESCRIPTION
P10-100-BL10-S	APEX 3D™ ARC Tibia, Left, Size 1, Short, 3DP
P10-100-BL1L-S	APEX 3D™ ARC Tibia, Left, Size 1, Long, 3DP
P10-100-BL1S-S	APEX 3D™ ARC Tibia, Left, Size 1, Standard, 3DP
P10-100-BL2L-S	APEX 3D™ ARC Tibia, Left, Size 2, Long, 3DP
P10-100-BL2S-S	APEX 3D™ ARC Tibia, Left, Size 2, Standard, 3DP
P10-100-BL3L-S	APEX 3D™ ARC Tibia, Left, Size 3, Long, 3DP
P10-100-BL3S-S	APEX 3D™ ARC Tibia, Left, Size 3, Standard, 3DP
P10-100-BL4L-S	APEX 3D™ ARC Tibia, Left, Size 4, Long, 3DP
P10-100-BL4S-S	APEX 3D™ ARC Tibia, Left, Size 4, Standard, 3DP
P10-100-BL5L-S	APEX 3D™ ARC Tibia, Left, Size 5, Long, 3DP
P10-100-BL5S-S	APEX 3D™ ARC Tibia, Left, Size 5, Standard, 3DP
P10-100-BL6L-S	APEX 3D™ ARC Tibia, Left, Size 6, Long, 3DP
P10-100-BL6S-S	APEX 3D™ ARC Tibia, Left, Size 6, Standard, 3DP
P10-100-BR10-S	APEX 3D™ ARC Tibia, Right, Size 1, Short, 3DP
P10-100-BR1L-S	APEX 3D™ ARC Tibia, Right, Size 1, Long, 3DP
P10-100-BR1S-S	APEX 3D™ ARC Tibia, Right, Size 1, Standard, 3DP
P10-100-BR2L-S	APEX 3D™ ARC Tibia, Right, Size 2, Long, 3DP
P10-100-BR2S-S	APEX 3D™ ARC Tibia, Right, Size 2, Standard, 3DP
P10-100-BR3L-S	APEX 3D™ ARC Tibia, Right, Size 3, Long, 3DP
P10-100-BR3S-S	APEX 3D™ ARC Tibia, Right, Size 3, Standard, 3DP
P10-100-BR4L-S	APEX 3D™ ARC Tibia, Right, Size 4, Long, 3DP
P10-100-BR4S-S	APEX 3D™ ARC Tibia, Right, Size 4, Standard, 3DP
P10-100-BR5L-S	APEX 3D™ ARC Tibia, Right, Size 5, Long, 3DP
P10-100-BR5S-S	APEX 3D™ ARC Tibia, Right, Size 5, Standard, 3DP
P10-100-BR6L-S	APEX 3D™ ARC Tibia, Right, Size 6, Long, 3DP
P10-100-BR6S-S	APEX 3D™ ARC Tibia, Right, Size 6, Standard, 3DP
P10-101-BL10-S	APEX 3D™ Tibia, Flat, Left, Size 1, Short, 3DP
P10-101-BL1L-S	APEX 3D™ Tibia, Flat, Left, Size 1, Long, 3DP
P10-101-BL1S-S	APEX 3D™ Tibia, Flat, Left, Size 1, Standard, 3DP
P10-101-BL2L-S	APEX 3D™ Tibia, Flat, Left, Size 2, Long, 3DP
P10-101-BL2S-S	APEX 3D™ Tibia, Flat, Left, Size 2, Standard, 3DP

Not all products available for sale in all markets. To determine availability in your marketplace, please contact your local Paragon 28 representative or email info@paragon28.com.

APEX 3D™ IMPLANTS

PART NUMBER	DESCRIPTION
P10-101-BL3L-S	APEX 3D™ Tibia, Flat, Left, Size 3, Long, 3DP
P10-101-BL3S-S	APEX 3D™ Tibia, Flat, Left, Size 3, Standard, 3DP
P10-101-BL4L-S	APEX 3D™ Tibia, Flat, Left, Size 4, Long, 3DP
P10-101-BL4S-S	APEX 3D™ Tibia, Flat, Left, Size 4, Standard, 3DP
P10-101-BL5L-S	APEX 3D™ Tibia, Flat, Left, Size 5, Long, 3DP
P10-101-BL5S-S	APEX 3D™ Tibia, Flat, Left, Size 5, Standard, 3DP
P10-101-BL6L-S	APEX 3D™ Tibia, Flat, Left, Size 6, Long, 3DP
P10-101-BL6S-S	APEX 3D™ Tibia, Flat, Left, Size 6, Standard, 3DP
P10-101-BR10-S	APEX 3D™ Tibia, Flat, Right, Size 1, Short, 3DP
P10-101-BR1L-S	APEX 3D™ Tibia, Flat, Right, Size 1, Long, 3DP
P10-101-BR1S-S	APEX 3D™ Tibia, Flat, Right, Size 1, Standard, 3DP
P10-101-BR2L-S	APEX 3D™ Tibia, Flat, Right, Size 2, Long, 3DP
P10-101-BR2S-S	APEX 3D™ Tibia, Flat, Right, Size 2, Standard, 3DP
P10-101-BR3L-S	APEX 3D™ Tibia, Flat, Right, Size 3, Long, 3DP
P10-101-BR3S-S	APEX 3D™ Tibia, Flat, Right, Size 3, Standard, 3DP
P10-101-BR4L-S	APEX 3D™ Tibia, Flat, Right, Size 4, Long, 3DP
P10-101-BR4S-S	APEX 3D™ Tibia, Flat, Right, Size 4, Standard, 3DP
P10-101-BR5L-S	APEX 3D™ Tibia, Flat, Right, Size 5, Long, 3DP
P10-101-BR5S-S	APEX 3D™ Tibia, Flat, Right, Size 5, Standard, 3DP
P10-101-BR6L-S	APEX 3D™ Tibia, Flat, Right, Size 6, Long, 3DP
P10-101-BR6S-S	APEX 3D™ Tibia, Flat, Right, Size 6, Standard, 3DP
P10-250-TLL0-S	APEX 3D™ Talus, Chamfer, Left, Size 1 Narrow, TPS
P10-250-TLL1-S	APEX 3D™ Talus, Chamfer, Left, Size 1, TPS
P10-250-TLL2-S	APEX 3D™ Talus, Chamfer, Left, Size 2, TPS
P10-250-TLL3-S	APEX 3D™ Talus, Chamfer, Left, Size 3, TPS
P10-250-TLL4-S	APEX 3D™ Talus, Chamfer, Left, Size 4, TPS
P10-250-TLL5-S	APEX 3D™ Talus, Chamfer, Left, Size 5, TPS
P10-250-TLR0-S	APEX 3D™ Talus, Chamfer, Right, Size 1 Narrow, TPS
P10-250-TLR1-S	APEX 3D™ Talus, Chamfer, Right, Size 1, TPS
P10-250-TLR2-S	APEX 3D™ Talus, Chamfer, Right, Size 2, TPS
P10-250-TLR3-S	APEX 3D™ Talus, Chamfer, Right, Size 3, TPS
P10-250-TLR4-S	APEX 3D™ Talus, Chamfer, Right, Size 4, TPS
P10-250-TLR5-S	APEX 3D™ Talus, Chamfer, Right, Size 5, TPS
P10-251-TLL0-S	APEX 3D™ Talus, Flat, Left, Size 1 Narrow, TPS
P10-251-TLL1-S	APEX 3D™ Talus, Flat, Left, Size 1, TPS
P10-251-TLL2-S	APEX 3D™ Talus, Flat, Left, Size 2, TPS
P10-251-TLL3-S	APEX 3D™ Talus, Flat, Left, Size 3, TPS
P10-251-TLL4-S	APEX 3D™ Talus, Flat, Left, Size 4, TPS
P10-251-TLL5-S	APEX 3D™ Talus, Flat, Left, Size 5, TPS
P10-251-TLR0-S	APEX 3D™ Talus, Flat, Right, Size 1 Narrow, TPS

Not all products available for sale in all markets. To determine availability in your marketplace, please contact your local Paragon 28 representative or email info@paragon28.com.

APEX 3D™ IMPLANTS

PART NUMBER	DESCRIPTION
P10-251-TLR1-S	APEX 3D™ Talus, Flat, Right, Size 1, TPS
P10-251-TLR2-S	APEX 3D™ Talus, Flat, Right, Size 2, TPS
P10-251-TLR3-S	APEX 3D™ Talus, Flat, Right, Size 3, TPS
P10-251-TLR4-S	APEX 3D™ Talus, Flat, Right, Size 4, TPS
P10-251-TLR5-S	APEX 3D™ Talus, Flat, Right, Size 5, TPS
P10-310-I106-S	APEX 3D™ Cross-linked Vitamin E POLY, SIZE 1 x 6MM, NEUTRAL
P10-310-I107-S	APEX 3D™ Cross-linked Vitamin E POLY, SIZE 1 x 7MM, NEUTRAL
P10-310-I108-S	APEX 3D™ Cross-linked Vitamin E POLY, SIZE 1 x 8MM, NEUTRAL
P10-310-I109-S	APEX 3D™ Cross-linked Vitamin E POLY, SIZE 1 x 9MM, NEUTRAL
P10-310-I110-S	APEX 3D™ Cross-linked Vitamin E POLY, SIZE 1 x 10MM, NEUTRAL
P10-310-I111-S	APEX 3D™ Cross-linked Vitamin E POLY, SIZE 1 x 11MM, NEUTRAL
P10-310-I112-S	APEX 3D™ Cross-linked Vitamin E POLY, SIZE 1 x 12MM, NEUTRAL
P10-310-I206-S	APEX 3D™ Cross-linked Vitamin E POLY, SIZE 2 x 6MM, NEUTRAL
P10-310-I207-S	APEX 3D™ Cross-linked Vitamin E POLY, SIZE 2 x 7MM, NEUTRAL
P10-310-I208-S	APEX 3D™ Cross-linked Vitamin E POLY, SIZE 2 x 8MM, NEUTRAL
P10-310-I209-S	APEX 3D™ Cross-linked Vitamin E POLY, SIZE 2 x 9MM, NEUTRAL
P10-310-I210-S	APEX 3D™ Cross-linked Vitamin E POLY, SIZE 2 x 10MM, NEUTRAL
P10-310-I211-S	APEX 3D™ Cross-linked Vitamin E POLY, SIZE 2 x 11MM, NEUTRAL
P10-310-I212-S	APEX 3D™ Cross-linked Vitamin E POLY, SIZE 2 x 12MM, NEUTRAL
P10-310-I306-S	APEX 3D™ Cross-linked Vitamin E POLY, SIZE 3 x 6MM, NEUTRAL
P10-310-I307-S	APEX 3D™ Cross-linked Vitamin E POLY, SIZE 3 x 7MM, NEUTRAL
P10-310-I308-S	APEX 3D™ Cross-linked Vitamin E POLY, SIZE 3 x 8MM, NEUTRAL
P10-310-I309-S	APEX 3D™ Cross-linked Vitamin E POLY, SIZE 3 x 9MM, NEUTRAL
P10-310-I310-S	APEX 3D™ Cross-linked Vitamin E POLY, SIZE 3 x 10MM, NEUTRAL
P10-310-I311-S	APEX 3D™ Cross-linked Vitamin E POLY, SIZE 3 x 11MM, NEUTRAL
P10-310-I312-S	APEX 3D™ Cross-linked Vitamin E POLY, SIZE 3 x 12MM, NEUTRAL
P10-310-I406-S	APEX 3D™ Cross-linked Vitamin E POLY, SIZE 4 x 6MM, NEUTRAL
P10-310-I407-S	APEX 3D™ Cross-linked Vitamin E POLY, SIZE 4 x 7MM, NEUTRAL
P10-310-I408-S	APEX 3D™ Cross-linked Vitamin E POLY, SIZE 4 x 8MM, NEUTRAL
P10-310-I409-S	APEX 3D™ Cross-linked Vitamin E POLY, SIZE 4 x 9MM, NEUTRAL
P10-310-I410-S	APEX 3D™ Cross-linked Vitamin E POLY, SIZE 4 x 10MM, NEUTRAL
P10-310-I411-S	APEX 3D™ Cross-linked Vitamin E POLY, SIZE 4 x 11MM, NEUTRAL
P10-310-I412-S	APEX 3D™ Cross-linked Vitamin E POLY, SIZE 4 x 12MM, NEUTRAL
P10-310-I506-S	APEX 3D™ Cross-linked Vitamin E POLY, SIZE 5 x 6MM, NEUTRAL
P10-310-I507-S	APEX 3D™ Cross-linked Vitamin E POLY, SIZE 5 x 7MM, NEUTRAL
P10-310-I508-S	APEX 3D™ Cross-linked Vitamin E POLY, SIZE 5 x 8MM, NEUTRAL
P10-310-I509-S	APEX 3D™ Cross-linked Vitamin E POLY, SIZE 5 x 9MM, NEUTRAL
P10-310-I510-S	APEX 3D™ Cross-linked Vitamin E POLY, SIZE 5 x 10MM, NEUTRAL
P10-310-I511-S	APEX 3D™ Cross-linked Vitamin E POLY, SIZE 5 x 11MM, NEUTRAL
P10-310-I512-S	APEX 3D™ Cross-linked Vitamin E POLY, SIZE 5 x 12MM, NEUTRAL

Section 16:
**PRESERVE™ BONE
WEDGE SYSTEM**

Not all products available for sale in all markets. To determine availability in your marketplace, please contact your local Paragon 28 representative or email info@paragon28.com.



AVITRAC™
MTP Revision Graft

PRESERVE™ AVITRAC® MTP REVISION IMPLANTS AND INSTRUMENTS

PART NUMBER	DESCRIPTION
P01-DWL-0915	AVITRAC™ MTP Revision Core, 9mm
P01-DWL-1115	AVITRAC™ MTP Revision Core, 11mm
P01-DWL-1315	AVITRAC™ MTP Revision Core, 13mm
P01-900-0001	Caddy, Lid, Allograft, Half
P01-900-0002	Caddy, MTP Allograft, Half
P01-900-1902	19mm MTP Spin Guard Female Reamer
P01-900-1903	19mm MTP Spin Guard Male Reamer
P01-900-2102	21mm MTP Spin Guard Female Reamer
P01-900-2103	21mm MTP Spin Guard Male Reamer
P99-192-1615	1.6 X 150 mm, K-Wire, Single Ended Trocar Tip, Smooth
PMT-1905	5 mm X 19mm MTP Disc Trial Handle
PMT-1908	8 mm X 19 mm MTP Disc Trial Handle
PMT-1910	10 mm X 18 mm MTP Disc Trial Handle
PMT-1915	19 mm X 15 mm MTP Disc Trial Handle
PMT-1920	19 mm X 20 mm MTP Disc Trial Handle
PMT-2105	5 mm X 21 mm MTP Disc Trial Handle
PMT-2108	8 mm X 21 mm MTP Disc Trial Handle
PMT-2110	10 mm X 21 mm MTP Disc Trial Handle

Not all products available for sale in all markets. To determine availability in your marketplace, please contact your local Paragon 28 representative or email info@paragon28.com.



Evans Lateral Column Lengthening Graft



Cotton Osteotomy Graft

PRESERVE™ EVANS AND COTTON IMPLANTS AND TRIALS

PART NUMBER	DESCRIPTION
PLCL-18006	Evans Wedge, 6mm
PLCL-20008	Evans Wedge, 8mm
PLCL-25010	Evans Wedge, 10mm
PLCL-30012	Evans Wedge, 12mm
PCOT-181405	Cotton Wedge, 5mm
PCOT-181406	Cotton Wedge, 6mm
PCOT-181407	Cotton Wedge, 7mm
PCOT-181408	Cotton Wedge, 8mm
P01-900-0001	Caddy, Lid, Allograft, Half
P01-900-0003	Caddy, Allograft, Evans And Cotton, Half
P99-150-0002	Flat Bone Tamp
P99-192-2315	2.3 X 150 mm K-Wire, Smooth
PCT-005	5 mm Cotton Wedge Trial Handles
PCT-006	6 mm Cotton Wedge Trial Handles
PCT-007	7 mm Cotton Wedge Trial Handles
PCT-008	8 mm Cotton Wedge Trial Handles
PET-0906	6 mm Evans Wedge 9 Degree, Trial Handles
PET-0908	8 mm Evans Wedge 9 Degree, Trial Handles
PET-0910	10 mm Evans Wedge 9 Degree, Trial Handles
PET-0912	12 mm Evans Wedge 9 Degree, Trial Handles

Not all products available for sale in all markets. To determine availability in your marketplace, please contact your local Paragon 28 representative or email info@paragon28.com.



HammerGraft™
Cancellous Spacer

PRESERVE™ LAPIDUS IMPLANTS AND TRIALS

PART NUMBER	DESCRIPTION
PLP-3005	Lapidus Wedge, 5°x 5mm
PLP-3008	Lapidus Wedge, 8°x 8mm
PLP-3010	Lapidus Wedge, 10°x 10mm
PLP-3012	Lapidus Wedge, 12°x 12mm
PLP-3014	Lapidus Wedge, 14mm, Universal (PARALLEL)
P01-900-0001	Caddy, Lid, Allograft, Half
P01-900-0004	Caddy, Allograft, Lapidus, Half
P99-150-0003	Radius Bone Tamp (Change To Curved Bone Tamp)
P99-192-2015	2.0 X 150 mm K-Wire, Smooth
PLT-0505	5 mm Lapidus, 5 Degree, Trial Handle
PLT-0808	8 mm Lapidus, 8 Degree, Trial Handle
PLT-1010	10 mm Lapidus, 10 Degree, Trial Handle
PLT-1212	12 mm Lapidus, 12 Degree, Trial Handle

Not all products available for sale in all markets. To determine availability in your marketplace, please contact your local Paragon 28 representative or email info@paragon28.com.



Lapidus Angular Length Restoring Graft

PRESERVE™ LAPIDUS IMPLANTS AND TRIALS

PART NUMBER	DESCRIPTION
PLP-3005	Lapidus Wedge, 5°x 5mm
PLP-3008	Lapidus Wedge, 8°x 8mm
PLP-3010	Lapidus Wedge, 10°x 10mm
PLP-3012	Lapidus Wedge, 12°x 12mm
PLP-3014	Lapidus Wedge, 14mm, Universal (PARALLEL)
P01-900-0001	Caddy, Lid, Allograft, Half
P01-900-0004	Caddy, Allograft, Lapidus, Half
P99-150-0003	Radius Bone Tamp (Change To Curved Bone Tamp)
P99-192-2015	2.0 X 150 mm K-Wire, Smooth
PLT-0505	5 mm Lapidus, 5 Degree, Trial Handle
PLT-0808	8 mm Lapidus, 8 Degree, Trial Handle
PLT-1010	10 mm Lapidus, 10 Degree, Trial Handle
PLT-1212	12 mm Lapidus, 12 Degree, Trial Handle

Not all products available for sale in all markets. To determine availability in your marketplace, please contact your local Paragon 28 representative or email info@paragon28.com.



MTP Length Restoring Graft

PRESERVE™ MTP IMPLANTS AND TRIALS

PART NUMBER	DESCRIPTION
PMT-21005	MTP Disc, 21 x 5mm
PMT-21008	MTP Disc, 21 x 8mm
PMT-21010	MTP Disc, 21 x 10mm
PMT-19005	MTP Disc, 19 x 5mm
PMT-19008	MTP Disc, 19 x 8mm
PMT-19010	MTP Disc, 19 x 10mm
PMT-19015	MTP Disc, 19 x 15mm
PMT-19020	MTP Disc, 19 x 20mm
P01-900-0001	Caddy, Lid, Allograft, Half
P01-900-0002	Caddy, MTP Allograft, Half
P01-900-1902	19mm MTP Spin Guard Female Reamer
P01-900-1903	19mm MTP Spin Guard Male Reamer
P01-900-2102	21mm MTP Spin Guard Female Reamer
P01-900-2103	21mm MTP Spin Guard Male Reamer
P99-192-1615	1.6 X 150 mm, K-Wire, Single Ended Trocar Tip, Smooth
PMT-1905	5 mm X 19mm MTP Disc Trial Handle
PMT-1908	8 mm X 19 mm MTP Disc Trial Handle
PMT-1910	10 mm X 18 mm MTP Disc Trial Handle
PMT-1915	19 mm X 15 mm MTP Disc Trial Handle
PMT-1920	19 mm X 20 mm MTP Disc Trial Handle
PMT-2105	5 mm X 21 mm MTP Disc Trial Handle
PMT-2108	8 mm X 21 mm MTP Disc Trial Handle
PMT-2110	10 mm X 21 mm MTP Disc Trial Handle

PRESERVE™ UNIVERSAL AND ILIAC WEDGES

PART NUMBER	DESCRIPTION
P0779	Universal Wedge, 2/3 Cortical Rim, Aseptic
P1250	Iliac Crest Wedges (Thick), Aseptic

Not all products available for sale in all markets. To determine availability in your marketplace, please contact your local Paragon 28 representative or email info@paragon28.com.

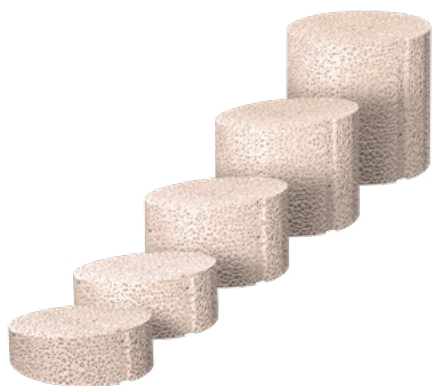

Subtalar Joint Distraction Arthrodesis Graft

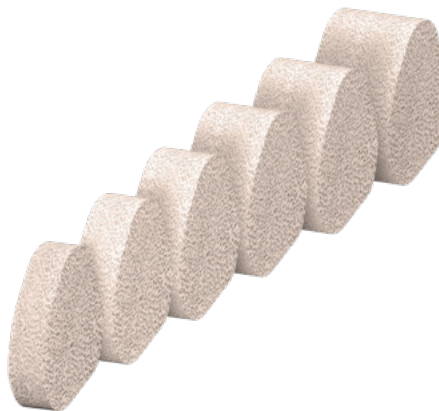

Calc-Cuboid Arthrodesis Lengthening Graft

PRESERVE™ SUBTALAR AND CALC-CUBOID IMPLANTS AND TRIALS

PART NUMBER	DESCRIPTION
PSBT-1005	Subtalar Distraction Arthrodesis Wedge, 10mm
PSBT-1206	Subtalar Distraction Arthrodesis Wedge, 12mm
PSBT-1407	Subtalar Distraction Arthrodesis Wedge, 14mm
PSBT-1608	Subtalar Distraction Arthrodesis Wedge, 16mm
PSBT-1818	Subtalar Distraction Arthrodesis Wedge, 18mm, Universal
P01-900-0001	Trial Caddy Lid
P01-900-0005	Subtalar & Calcaneo Cuboid Trial Caddy
P99-192-2315	K Wire, Smooth, 2.3 X 150 mm
P99-150-0003	Radius Bone Tamp
PCC-008	Trial Handle, Calc Cuboid, 8mm
PCC-010	Trial Handle, Calc Cuboid, 10mm
PCC-012	Trial Handle, Calc Cuboid, 12mm
PCC-014	Trial Handle, Calc Cuboid, 14mm
PCC-016	Trial Handle, Calc Cuboid, 16mm
PST-0001	Subtalar Handle
PST-0002	Subtalar Coin Correction Guide
PST-1005	10 X 5 Subtalar Trial
PST-1206	12 X 6 Subtalar Trial
PST-1407	14 X 7 Subtalar Trial
PST-1608	16 X 8 Subtalar Trial
PCCC-0804	Calcaneo-Cuboid Joint Wedge, 8mm
PCCC-1005	Calcaneo-Cuboid Joint Wedge, 10mm
PCCC-1206	Calcaneo-Cuboid Joint Wedge, 12mm
PCCC-1406	Calcaneo-Cuboid Joint Wedge, 14mm
PCCC-1606	Calcaneo-Cuboid Joint Wedge, 16mm
PCCC-1800	Calcaneo-Cuboid Joint Wedge, 18mm, Universal

Section 17:
TITAN 3-D™

Not all products available for sale in all markets. To determine availability in your marketplace, please contact your local Paragon 28 representative or email info@paragon28.com.

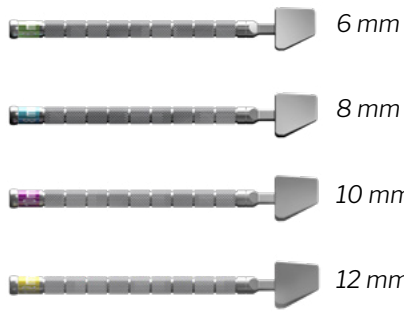

Evans Trials

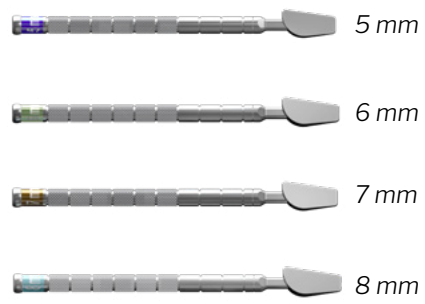

Cotton Trials

Titan 3-D™ Evans and Cotton Implants

PART NUMBER	DESCRIPTION
P03-900-T3DC-3	Titan 3-D Wedge System, Caddy Lid
P03-900-T3DC-2	Titan 3-D Wedge System, Trial Caddy Base
P99-192-2315	2.3 X 150 mm K-Wire, Smooth
PCT-005	5 mm Cotton Wedge Trial Handles
PCT-006	6 mm Cotton Wedge Trial Handles
PCT-007	7 mm Cotton Wedge Trial Handles
PCT-008	8 mm Cotton Wedge Trial Handles
PET-0906	6 mm Evans Wedge 9 Degree, Trial Handles
PET-0908	8 mm Evans Wedge 9 Degree, Trial Handles
PET-0910	10 mm Evans Wedge 9 Degree, Trial Handles
PET-0912	12 mm Evans Wedge 9 Degree, Trial Handles

Not all products available for sale in all markets. To determine availability in your marketplace, please contact your local Paragon 28 representative or email info@paragon28.com.



Cotton Wedge



Evans Large Wedge

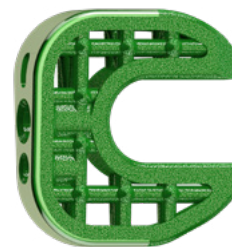

Evans Small Wedge

Titan 3-D™ Instrumentation

PART NUMBER	DESCRIPTION
P03-900-T3DC-3	Titan 3-D Wedge System, Caddy Lid
P03-900-T3DC-1	Titan 3-D Wedge System, Instrument Caddy Base
P03-905-9001	Titan 3-D Wedge System, Inserter, Evans
P03-905-9002	Titan 3-D Wedge System, Inserter, Cotton
P03-950-0001	Titan 3-D Wedge System, Precision Guide, Evans, Right
P03-950-0002	Titan 3-D Wedge System, Precision Guide, Evans, Left
P03-950-0003	Titan 3-D Wedge System, Precision Guide, Cotton, Right
P03-950-0004	Titan 3-D Wedge System, Precision Guide, Cotton, Left
P51-950-0002	Precision Guide Set Screw, Long
P51-950-0012	K-Wire Guide, 1.2mm
P03-901-0001	Titan 3-D Wedge System, Driver, 2mm Hex
P03-940-9001	Titan 3-D Wedge System, Resection Guide, Evans
P03-940-9002	Titan 3-D Wedge System, Resection Guide, Cotton, Even Sizes
P03-940-9003	Titan 3-D Wedge System, Resection Guide, Cotton, Odd Sizes
P03-COT-1005-S	Titan 3-D Wedge, Cotton, 5mm
P03-COT-1006-S	Titan 3-D Wedge, Cotton, 6mm
P03-COT-1007-S	Titan 3-D Wedge, Cotton, 7mm
P03-COT-1008-S	Titan 3-D Wedge, Cotton, 8mm
P03-EVN-0006-S	Titan 3-D Wedge, Evans, Small, 6mm x 16mm
P03-EVN-0008-S	Titan 3-D Wedge, Evans, Small, 8mm x 16mm
P03-EVN-0010-S	Titan 3-D Wedge, Evans, Small, 10mm x 16mm
P03-EVN-0012-S	Titan 3-D Wedge, Evans, Small, 12mm x 16mm
P03-EVN-1006-S	Titan 3-D Wedge, Evans, Large, 6mm x 19mm
P03-EVN-1008-S	Titan 3-D Wedge, Evans, Large, 8mm x 19mm
P03-EVN-1010-S	Titan 3-D Wedge, Evans, Large, 10mm x 19mm
P03-EVN-1012-S	Titan 3-D Wedge, Evans, Large, 12mm x 19mm

Section 18:
BIOLOGICS

Not all products available for sale in all markets. To determine availability in your marketplace, please contact your local Paragon 28 representative or email info@paragon28.com.



BEAST 100® DBM (100%) INJECTABLE PUTTY

PART NUMBER	DESCRIPTION
P01-DBM-1001	Beast DBM 1.0 CC
P01-DBM-1003	Beast DBM 2.5 CC
P01-DBM-1005	Beast DBM 5.0 CC
P01-DBM-1010	Beast DBM 10.0 CC



PARADERM®

PART NUMBER	DESCRIPTION
PDMW-4X4	ParaDerm®, 4x4 cm Dermal Matrix
PDMW-4X8	ParaDerm®, 4x8 cm Dermal Matrix

Not all products available for sale in all markets. To determine availability in your marketplace, please contact your local Paragon 28 representative or email info@paragon28.com.

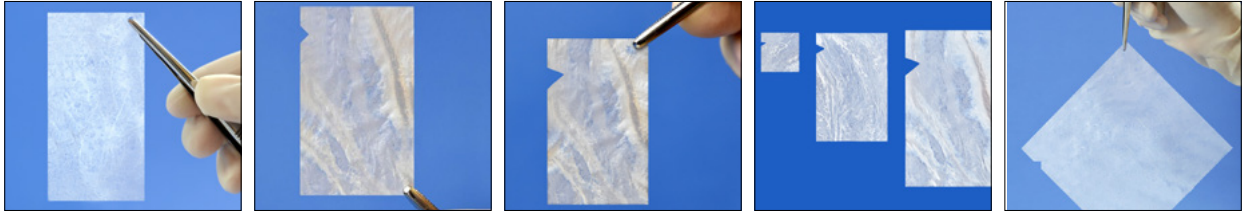

PRO3™ AMNION

PART NUMBER	DESCRIPTION
Cord	
P01-AMC-0203	PRO3™-C Amniotic Cord Membrane, 2x3cm Thick
P01-AMC-0306	PRO3™-C Amniotic Cord Membrane, 3x6cm Thick
Placenta	
P01-AMP-0203	PRO3™-P Amniotic Placental Membrane, 2x3cm, Thin
P01-AMP-0404	PRO3™-P Amniotic Placental Membrane, 4x4cm, Thin
P01-AMP-0408	PRO3™-P Amniotic Placental Membrane, 4x8cm, Thin
P01-AMP-0707	PRO3™-P Amniotic Placental Membrane, 7x7cm, Thin



Flowable	
P01-AMF-0025	PRO3™-F Amniotic Injectable Fluid, 0.25ml
P01-AMF-0050	PRO3™-F Amniotic Injectable Fluid, 0.50ml
P01-AMF-0100	PRO3™-F Amniotic Injectable Fluid, 1.00ml
P01-AMF-0200	PRO3™-F Amniotic Injectable Fluid, 2.00ml

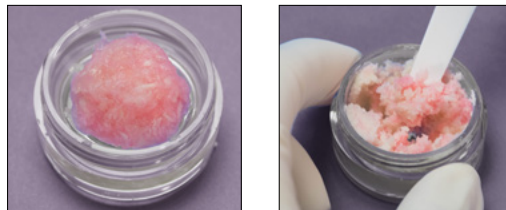

V92™

PART NUMBER	DESCRIPTION
P01-V92-0100	V92™, Cellular Bone Matrix, 1.0cc
P01-V92-0250	V92™, Cellular Bone Matrix, 2.5cc
P01-V92-0500	V92™, Cellular Bone Matrix, 5.0cc
P01-V92-1000	V92™, Cellular Bone Matrix, 10.0cc
P01-V92-0251	V92 FiberCell, 2.5cc
P01-V92-0501	V92 FiberCell, 5.0cc
P01-V92-1001	V92 FiberCell, 10cc

BACK TO TABLE OF CONTENTS

Section 19:
**BONE GRAFT
HARVESTING SYSTEM**

Not all products available for sale in all markets. To determine availability in your marketplace, please contact your local Paragon 28 representative or email info@paragon28.com.

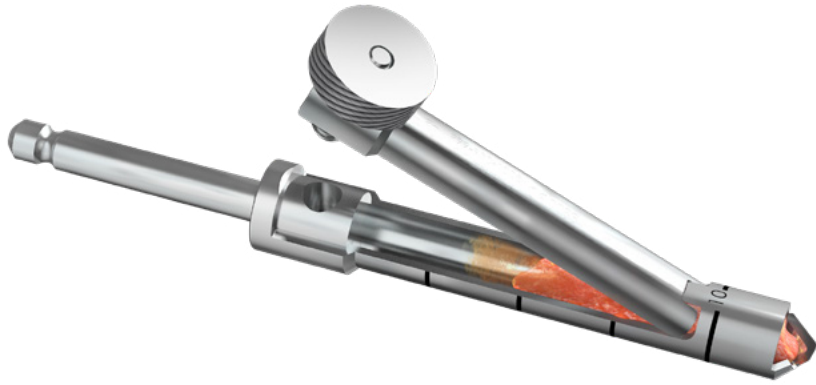

BONE GRAFT HARVESTERS AND INSTRUMENTATION

PART NUMBER	DESCRIPTION
P50-900-49GL	Lapidus Cut Guide Caddy Lid
P99-900-HARV	Bone Graft Harvester Caddy
P99-930-2006	Morselizing Bone Graft Harvester, Door, 6mm
P99-930-2008	Morselizing Bone Graft Harvester, Door, 8mm
P99-930-2010	Morselizing Bone Graft Harvester, Door, 10mm
P99-930-2106	Morselizing Bone Graft Harvester, AO, 6mm
P99-930-2108	Morselizing Bone Graft Harvester, AO, 8mm
P99-930-2110	Morselizing Bone Graft Harvester, AO, 10mm
P99-192-2315	K-Wire, Single Ended Trocar Tip, SMOOTH, 2.3 x 150mm

Section 20:
**MONSTER® BITE
SCREW SYSTEM**

Not all products available for sale in all markets. To determine availability in your marketplace, please contact your local Paragon 28 representative or email info@paragon28.com.



MBIT - MONSTER BITE CADDY

PART NUMBER	DESCRIPTION
P24-900-BITE-1	Monster® Bite Caddy, Base
P24-900-BITE-2	Monster® Bite Caddy, Insert
P24-900-BITE-3	Monster® Bite Caddy, Lid
P24-020-008L	Monster® Bite Screw, 2.0 x 8mm, Long Thread
P24-020-009L	Monster® Bite Screw, 2.0 x 9mm, Long Thread
P24-020-010L	Monster® Bite Screw, 2.0 x 10mm, Long Thread
P24-020-010S	Monster® Bite Screw, 2.0 x 10mm, Short Thread
P24-020-011L	Monster® Bite Screw, 2.0 x 11mm, Long Thread
P24-020-011S	Monster® Bite Screw, 2.0 x 11mm, Short Thread
P24-020-012L	Monster® Bite Screw, 2.0 x 12mm, Long Thread
P24-020-012S	Monster® Bite Screw, 2.0 x 12mm, Short Thread
P24-020-013L	Monster® Bite Screw, 2.0 x 13mm, Long Thread
P24-020-013S	Monster® Bite Screw, 2.0 x 13mm, Short Thread
P24-020-014L	Monster® Bite Screw, 2.0 x 14mm, Long Thread
P24-020-014S	Monster® Bite Screw, 2.0 x 14mm, Short Thread
P24-020-016L	Monster® Bite Screw, 2.0 x 16mm, Long Thread
P24-020-016S	Monster® Bite Screw, 2.0 x 16mm, Short Thread
P24-027-010S	Monster® Bite Screw, 2.7 x 10mm, Short Thread
P24-027-012S	Monster® Bite Screw, 2.7 x 12mm, Short Thread
P24-027-014S	Monster® Bite Screw, 2.7 x 14mm, Short Thread
P24-027-016S	Monster® Bite Screw, 2.7 x 16mm, Short Thread
P24-027-018S	Monster® Bite Screw, 2.7 x 18mm, Short Thread
P24-027-020S	Monster® Bite Screw, 2.7 x 20mm, Short Thread
P24-027-022S	Monster® Bite Screw, 2.7 x 22mm, Short Thread
P24-027-024S	Monster® Bite Screw, 2.7 x 24mm, Short Thread
P24-905-0001	Monster® Bite, Driver, AO
P24-905-0002	Monster® Bite, Handle, Counter Lever
P24-951-2027	Monster® Bite, Depth Gauge, K-wire measuring
P99-000-AOSS	P28, Handle, A/O, Cannulated, Non-ratcheting, Short Streamline
P99-150-0001	P28, Forceps
P99-150-0039	P28, Clamp, Weil Clamp
P99-192-1110	P28, K-Wire, Ø1.1x 100mm, Single, Smooth
P99-192-1410	P28, K-Wire, Ø1.4x 100mm, Single, Smooth

Section 21:
MONSTER®
FOREFOOT SYSTEM

Not all products available for sale in all markets. To determine availability in your marketplace, please contact your local Paragon 28 representative or email info@paragon28.com.

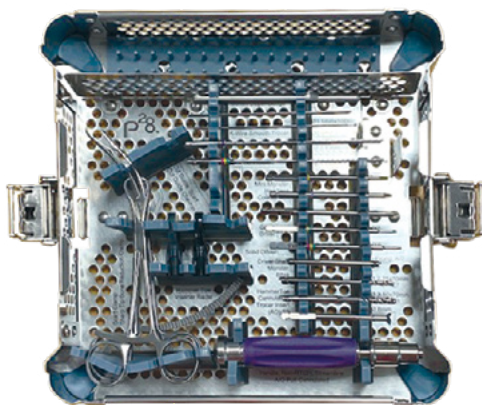

MONSTER® FOREFOOT SYSTEM

PART NUMBER	DESCRIPTION
P20-915-2500	Countersink, 2.5 Headless
P20-915-3000	Countersink, 3.0mm, Headless
P24-905-0001	Driver Shaft, 3-Prong, Monster BITES, AO
P24-951-2027	MONSTER BITE, 2.0MM - 2.7MM DEPTH GAUGE
P40-900-0801	Bone Planer Assembly, 8mm
P40-900-2750	Hammertoe, Inserter, Ø2.75mm
P40-900-3500	Implant Inserter, 3.5mm
P40-920-2707	Drill Assembly, 2.75mm, Cannulated
P40-920-3507	Drill, 3.5mm, Cannulated (Patent Pending)
P99-000-AOSS	Mini-AO, Non-Ratcheting Handle Streamline, Cannulated
P99-110-1712	drill, cannulated, 1.7 x 110 mm
P99-110-2112	Drill, 2.0 x 120mm, Cannulated, AO
P99-150-0013	Sharp Tip Bone Reduction Clamp
P99-150-0130	Scarf Forceps 160mm curved
P99-190-TT08	Screw Driver Attachment, Cannulated, Modified TX-8
P99-190-TX06	Modified Tx-6 Screw Driver Attachment, Cannulated
P99-191-TX06	Screw Driver Attachment, Solid, AO, HX-6
P99-192-0910	0.9 X 100 Mm, K Wire, Trocar/Round
P99-192-1110	K-Wire, Single Ended Trocar Tip, SMOOTH, 1.1 x 100mm
P99-901-4001	Case Tray, Forefoot Instruments, Half DIN Lid
P99-901-4002	Case Tray, Forefoot Instruments, Half DIN Base

Section 22:
MINI-MONSTER®
SCREW SYSTEM

Not all products available for sale in all markets. To determine availability in your marketplace, please contact your local Paragon 28 representative or email info@paragon28.com.

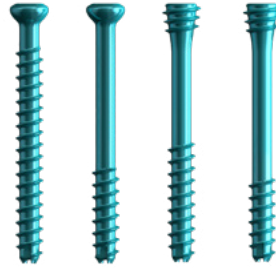

2.0 mm Headed and Headless
Mini-Monster® Screws

2.0 MINI-MONSTER® SCREWS AND INSTRUMENTATION

PART NUMBER	DESCRIPTION
P20-900-0015-1	Caddy, Mini Monster, 2.0mm Lag Screw, Base
P20-900-0015-2	Caddy, Mini Monster, 2.0mm Lag Screw, Lid
P20-900-0015-3	Caddy, Mini Monster, 2.0mm Lag Screw, Instrument Base
P20-900-MLID	Caddy, Mini Monster, Instrument Lid
P20-520-030L	Mini-Monster® Headless, Long Thread, 2.0 x 30mm
P20-520-032L	Mini-Monster® Headless, Long Thread, 2.0 x 32mm
P20-520-034L	Mini-Monster® Headless, Long Thread, 2.0 x 34mm
P20-520-036L	Mini-Monster® Headless, Long Thread, 2.0 x 36mm
P20-520-038L	Mini-Monster® Headless, Long Thread, 2.0 x 38mm
P20-520-040L	Mini-Monster® Headless, Long Thread, 2.0 x 40mm
P20-520-042L	Mini-Monster® Headless, Long Thread, 2.0 x 42mm
P20-520-044L	Mini-Monster® Headless, Long Thread, 2.0 x 44mm
P20-520-046L	Mini-Monster® Headless, Long Thread, 2.0 x 46mm
P20-520-048L	Mini-Monster® Headless, Long Thread, 2.0 x 48mm
P20-520-050L	Mini-Monster® Headless, Long Thread, 2.0 x 50mm
P20-520-010S	Mini-Monster® Headless, Short Thread, 2.0 x 10mm
P20-520-011S	Mini-Monster® Headless, Short Thread, 2.0 x 11mm
P20-520-012S	Mini-Monster® Headless, Short Thread, 2.0 x 12mm
P20-520-013S	Mini-Monster® Headless, Short Thread, 2.0 x 13mm
P20-520-014S	Mini-Monster® Headless, Short Thread, 2.0 x 14mm
P20-520-015S	Mini-Monster® Headless, Short Thread, 2.0 x 15mm
P20-520-016S	Mini-Monster® Headless, Short Thread, 2.0 x 16mm
P20-520-017S	Mini-Monster® Headless, Short Thread, 2.0 x 17mm
P20-520-018S	Mini-Monster® Headless, Short Thread, 2.0 x 18mm
P20-520-019S	Mini-Monster® Headless, Short Thread, 2.0 x 19mm
P20-520-020S	Mini-Monster® Headless, Short Thread, 2.0 x 20mm
P20-520-022S	Mini-Monster® Headless, Short Thread, 2.0 x 22mm
P20-520-024S	Mini-Monster® Headless, Short Thread, 2.0 x 24mm
P20-520-026S	Mini-Monster® Headless, Short Thread, 2.0 x 26mm
P20-520-028S	Mini-Monster® Headless, Short Thread, 2.0 x 28mm

Not all products available for sale in all markets. To determine availability in your marketplace, please contact your local Paragon 28 representative or email info@paragon28.com.

2.0 MINI-MONSTER® SCREWS AND INSTRUMENTATION

PART NUMBER	DESCRIPTION
P20-520-030S	Mini-Monster® Headless, Short Thread, 2.0 x 30mm
P20-520-032S	Mini-Monster® Headless, Short Thread, 2.0 x 32mm
P20-520-034S	Mini-Monster® Headless, Short Thread, 2.0 x 34mm
P20-520-036S	Mini-Monster® Headless, Short Thread, 2.0 x 36mm
P20-520-038S	Mini-Monster® Headless, Short Thread, 2.0 x 38mm
P20-520-040S	Mini-Monster® Headless, Short Thread, 2.0 x 40mm
P20-520-042S	Mini-Monster® Headless, Short Thread, 2.0 x 42mm
P20-520-044S	Mini-Monster® Headless, Short Thread, 2.0 x 44mm
P20-520-046S	Mini-Monster® Headless, Short Thread, 2.0 x 46mm
P20-520-048S	Mini-Monster® Headless, Short Thread, 2.0 x 48mm
P20-520-050S	Mini-Monster® Headless, Short Thread, 2.0 x 50mm
P20-120-008F	Mini-Monster® Headed, Full Thread, 2.0 x 8mm
P20-120-009F	Mini-Monster® Headed, Full Thread, 2.0 x 9mm
P20-120-010F	Mini-Monster® Headed, Full Thread, 2.0 x 10mm
P20-120-011F	Mini-Monster® Headed, Full Thread, 2.0 x 11mm
P20-120-012F	Mini-Monster® Headed, Full Thread, 2.0 x 12mm
P20-120-013F	Mini-Monster® Headed, Full Thread, 2.0 x 13mm
P20-120-014F	Mini-Monster® Headed, Full Thread, 2.0 x 14mm
P20-120-015F	Mini-Monster® Headed, Full Thread, 2.0 x 15mm
P20-120-016F	Mini-Monster® Headed, Full Thread, 2.0 x 16mm
P20-120-017F	Mini-Monster® Headed, Full Thread, 2.0 x 17mm
P20-120-018F	Mini-Monster® Headed, Full Thread, 2.0 x 18mm
P20-120-019F	Mini-Monster® Headed, Full Thread, 2.0 x 19mm
P20-120-020F	Mini-Monster® Headed, Full Thread, 2.0 x 20mm
P20-120-022F	Mini-Monster® Headed, Full Thread, 2.0 x 22mm
P20-120-024F	Mini-Monster® Headed, Full Thread, 2.0 x 24mm
P20-120-026F	Mini-Monster® Headed, Full Thread, 2.0 x 26mm
P20-120-028F	Mini-Monster® Headed, Full Thread, 2.0 x 28mm
P20-120-030F	Mini-Monster® Headed, Full Thread, 2.0 x 30mm
P20-120-032F	Mini-Monster® Headed, Full Thread, 2.0 x 32mm
P20-120-034F	Mini-Monster® Headed, Full Thread, 2.0 x 34mm
P20-120-036F	Mini-Monster® Headed, Full Thread, 2.0 x 36mm
P20-120-038F	Mini-Monster® Headed, Full Thread, 2.0 x 38mm
P20-120-040F	Mini-Monster® Headed, Full Thread, 2.0 x 40mm
P20-120-042F	Mini-Monster® Headed, Full Thread, 2.0 x 42mm
P20-120-044F	Mini-Monster® Headed, Full Thread, 2.0 x 44mm
P20-120-046F	Mini-Monster® Headed, Full Thread, 2.0 x 46mm
P20-120-048F	Mini-Monster® Headed, Full Thread, 2.0 x 48mm
P20-120-050F	Mini-Monster® Headed, Full Thread, 2.0 x 50mm
P20-120-008S	Mini-Monster® Headed, Short Thread, 2.0 x 8mm

Not all products available for sale in all markets. To determine availability in your marketplace, please contact your local Paragon 28 representative or email info@paragon28.com.

2.0 MINI-MONSTER® SCREWS AND INSTRUMENTATION

PART NUMBER	DESCRIPTION
P20-120-009S	Mini-Monster® Headed, Short Thread, 2.0 x 9mm
P20-120-010S	Mini-Monster® Headed, Short Thread, 2.0 x 10mm
P20-120-011S	Mini-Monster® Headed, Short Thread, 2.0 x 11mm
P20-120-012S	Mini-Monster® Headed, Short Thread, 2.0 x 12mm
P20-120-013S	Mini-Monster® Headed, Short Thread, 2.0 x 13mm
P20-120-014S	Mini-Monster® Headed, Short Thread, 2.0 x 14mm
P20-120-015S	Mini-Monster® Headed, Short Thread, 2.0 x 15mm
P20-120-016S	Mini-Monster® Headed, Short Thread, 2.0 x 16mm
P20-120-017S	Mini-Monster® Headed, Short Thread, 2.0 x 17mm
P20-120-018S	Mini-Monster® Headed, Short Thread, 2.0 x 18mm
P20-120-019S	Mini-Monster® Headed, Short Thread, 2.0 x 19mm
P20-120-020S	Mini-Monster® Headed, Short Thread, 2.0 x 20mm
P20-120-022S	Mini-Monster® Headed, Short Thread, 2.0 x 22mm
P20-120-024S	Mini-Monster® Headed, Short Thread, 2.0 x 24mm
P20-120-026S	Mini-Monster® Headed, Short Thread, 2.0 x 26mm
P20-120-028S	Mini-Monster® Headed, Short Thread, 2.0 x 28mm
P20-120-030S	Mini-Monster® Headed, Short Thread, 2.0 x 30mm
P20-120-032S	Mini-Monster® Headed, Short Thread, 2.0 x 32mm
P20-120-034S	Mini-Monster® Headed, Short Thread, 2.0 x 34mm
P20-120-036S	Mini-Monster® Headed, Short Thread, 2.0 x 36mm
P20-120-038S	Mini-Monster® Headed, Short Thread, 2.0 x 38mm
P20-120-040S	Mini-Monster® Headed, Short Thread, 2.0 x 40mm
P20-120-042S	Mini-Monster® Headed, Short Thread, 2.0 x 42mm
P20-120-044S	Mini-Monster® Headed, Short Thread, 2.0 x 44mm
P20-120-046S	Mini-Monster® Headed, Short Thread, 2.0 x 46mm
P20-120-048S	Mini-Monster® Headed, Short Thread, 2.0 x 48mm
P20-120-050S	Mini-Monster® Headed, Short Thread, 2.0 x 50mm
P20-020-DW00	2.0 Deep Well Washer, Mini-Monster®
P20-910-2000	Countersink, 2.0 Headed
P20-915-2000	Countersink, 2.0 Headless
P20-941-2025	Tissue Protector, Drill, 2.0 & 2.5
P20-942-2000	Tissue Protector, Overdrill, 2.0
P20-951-2040	Depth Gauge (2.0 - 4.0 mm)
P99-110-1712	Drill, Cannulated, 1.7 x 110 mm
P99-110-2011	Overdrill, Cannulated, 2.0 x 110 mm
P99-150-0001	Screw Forceps
P99-190-TX06	Modified Tx-6 Screw Driver Attachment, Cannulated
P99-191-TX06	Modified Hx6 x 83mm Solid Driver
P99-192-0915	K-Wire, Single Ended Trocar Tip, Smooth, 0.9 x 150 mm
P99-292-0915	K-Wire, Double Ended Trocar Tip, Smooth, 0.9 x 150 mm

JUMP TO MINI-MONSTER 2.0
STERILE PACKAGED PRODUCT



Not all products available for sale in all markets. To determine availability in your marketplace, please contact your local Paragon 28 representative or email info@paragon28.com.



2.5 mm Headed and Headless Mini-Monster® Screws

2.5 MINI-MONSTER® SCREWS AND INSTRUMENTATION

PART NUMBER	DESCRIPTION
P20-900-00156-1	Caddy, Mini Monster, 2.5mm Lag Screw, Base
P20-900-0016-2	Caddy, Mini Monster, 2.5mm Lag Screw, Lid
P20-900-0016-3	Caddy, Mini Monster, 2.5mm Lag Screw, Instrument Base
P20-900-MLID	Caddy, Mini Monster, Instrument Lid
P20-525-030L	Mini-Monster® Cannulated, Long Thread Screw, Headless, 2.5 x 30 mm
P20-525-032L	Mini-Monster® Cannulated, Long Thread Screw, Headless, 2.5 x 32 mm
P20-525-034L	Mini-Monster® Cannulated, Long Thread Screw, Headless, 2.5 x 34 mm
P20-525-036L	Mini-Monster® Cannulated, Long Thread Screw, Headless, 2.5 x 36 mm
P20-525-038L	Mini-Monster® Cannulated, Long Thread Screw, Headless, 2.5 x 38 mm
P20-525-040L	Mini-Monster® Cannulated, Long Thread Screw, Headless, 2.5 x 40 mm
P20-525-042L	Mini-Monster® Cannulated, Long Thread Screw, Headless, 2.5 x 42 mm
P20-525-044L	Mini-Monster® Cannulated, Long Thread Screw, Headless, 2.5 x 44 mm
P20-525-046L	Mini-Monster® Cannulated, Long Thread Screw, Headless, 2.5 x 46 mm
P20-525-048L	Mini-Monster® Cannulated, Long Thread Screw, Headless, 2.5 x 48 mm
P20-525-050L	Mini-Monster® Cannulated, Long Thread Screw, Headless, 2.5 x 50 mm
P20-525-010S	Mini-Monster® Cannulated, Short Thread Screw, Headless, 2.5 x 10 mm
P20-525-011S	Mini-Monster® Cannulated, Short Thread Screw, Headless, 2.5 x 11 mm
P20-525-012S	Mini-Monster® Cannulated, Short Thread Screw, Headless, 2.5 x 12 mm
P20-525-013S	Mini-Monster® Cannulated, Short Thread Screw, Headless, 2.5 x 13 mm
P20-525-014S	Mini-Monster® Cannulated, Short Thread Screw, Headless, 2.5 x 14 mm
P20-525-015S	Mini-Monster® Cannulated, Short Thread Screw, Headless, 2.5 x 15 mm
P20-525-016S	Mini-Monster® Cannulated, Short Thread Screw, Headless, 2.5 x 16 mm
P20-525-017S	Mini-Monster® Cannulated, Short Thread Screw, Headless, 2.5 x 17 mm
P20-525-018S	Mini-Monster® Cannulated, Short Thread Screw, Headless, 2.5 x 18 mm
P20-525-019S	Mini-Monster® Cannulated, Short Thread Screw, Headless, 2.5 x 19 mm
P20-525-020S	Mini-Monster® Cannulated, Short Thread Screw, Headless, 2.5 x 20 mm
P20-525-022S	Mini-Monster® Cannulated, Short Thread Screw, Headless, 2.5 x 22 mm
P20-525-024S	Mini-Monster® Cannulated, Short Thread Screw, Headless, 2.5 x 24 mm
P20-525-026S	Mini-Monster® Cannulated, Short Thread Screw, Headless, 2.5 x 26 mm
P20-525-028S	Mini-Monster® Cannulated, Short Thread Screw, Headless, 2.5 x 28 mm

Not all products available for sale in all markets. To determine availability in your marketplace, please contact your local Paragon 28 representative or email info@paragon28.com.

2.5 MINI-MONSTER® SCREWS AND INSTRUMENTATION

PART NUMBER	DESCRIPTION
P20-525-030S	Mini-Monster® Cannulated, Short Thread Screw, Headless, 2.5 x 30 mm
P20-525-032S	Mini-Monster® Cannulated, Short Thread Screw, Headless, 2.5 x 32 mm
P20-525-034S	Mini-Monster® Cannulated, Short Thread Screw, Headless, 2.5 x 34 mm
P20-525-036S	Mini-Monster® Cannulated, Short Thread Screw, Headless, 2.5 x 36 mm
P20-525-038S	Mini-Monster® Cannulated, Short Thread Screw, Headless, 2.5 x 38 mm
P20-525-040S	Mini-Monster® Cannulated, Short Thread Screw, Headless, 2.5 x 40 mm
P20-525-042S	Mini-Monster® Cannulated, Short Thread Screw, Headless, 2.5 x 42 mm
P20-525-044S	Mini-Monster® Cannulated, Short Thread Screw, Headless, 2.5 x 44 mm
P20-525-046S	Mini-Monster® Cannulated, Short Thread Screw, Headless, 2.5 x 46 mm
P20-525-048S	Mini-Monster® Cannulated, Short Thread Screw, Headless, 2.5 x 48 mm
P20-525-050S	Mini-Monster® Cannulated, Short Thread Screw, Headless, 2.5 x 50 mm
P20-125-010F	Mini-Monster® Cannulated, Full Thread Screw, Headed, 2.5 x 10 mm
P20-125-011F	Mini-Monster® Cannulated, Full Thread Screw, Headed, 2.5 x 11 mm
P20-125-012F	Mini-Monster® Cannulated, Full Thread Screw, Headed, 2.5 x 12 mm
P20-125-013F	Mini-Monster® Cannulated, Full Thread Screw, Headed, 2.5 x 13 mm
P20-125-014F	Mini-Monster® Cannulated, Full Thread Screw, Headed, 2.5 x 14 mm
P20-125-015F	Mini-Monster® Cannulated, Full Thread Screw, Headed, 2.5 x 15 mm
P20-125-016F	Mini-Monster® Cannulated, Full Thread Screw, Headed, 2.5 x 16 mm
P20-125-017F	Mini-Monster® Cannulated, Full Thread Screw, Headed, 2.5 x 17 mm
P20-125-018F	Mini-Monster® Cannulated, Full Thread Screw, Headed, 2.5 x 18 mm
P20-125-019F	Mini-Monster® Cannulated, Full Thread Screw, Headed, 2.5 x 19 mm
P20-125-020F	Mini-Monster® Cannulated, Full Thread Screw, Headed, 2.5 x 20 mm
P20-125-022F	Mini-Monster® Cannulated, Full Thread Screw, Headed, 2.5 x 22 mm
P20-125-024F	Mini-Monster® Cannulated, Full Thread Screw, Headed, 2.5 x 24 mm
P20-125-026F	Mini-Monster® Cannulated, Full Thread Screw, Headed, 2.5 x 26 mm
P20-125-028F	Mini-Monster® Cannulated, Full Thread Screw, Headed, 2.5 x 28 mm
P20-125-030F	Mini-Monster® Cannulated, Full Thread Screw, Headed, 2.5 x 30 mm
P20-125-032F	Mini-Monster® Cannulated, Full Thread Screw, Headed, 2.5 x 32 mm
P20-125-034F	Mini-Monster® Cannulated, Full Thread Screw, Headed, 2.5 x 34 mm
P20-125-036F	Mini-Monster® Cannulated, Full Thread Screw, Headed, 2.5 x 36 mm
P20-125-038F	Mini-Monster® Cannulated, Full Thread Screw, Headed, 2.5 x 38 mm
P20-125-040F	Mini-Monster® Cannulated, Full Thread Screw, Headed, 2.5 x 40 mm
P20-125-042F	Mini-Monster® Cannulated, Full Thread Screw, Headed, 2.5 x 42 mm
P20-125-044F	Mini-Monster® Cannulated, Full Thread Screw, Headed, 2.5 x 44 mm
P20-125-046F	Mini-Monster® Cannulated, Full Thread Screw, Headed, 2.5 x 46 mm
P20-125-048F	Mini-Monster® Cannulated, Full Thread Screw, Headed, 2.5 x 48 mm
P20-125-050F	Mini-Monster® Cannulated, Full Thread Screw, Headed, 2.5 x 50 mm
P20-125-010S	Mini-Monster® Cannulated, Short Thread Screw, Headed, 2.5 x 10 mm
P20-125-011S	Mini-Monster® Cannulated, Short Thread Screw, Headed, 2.5 x 11 mm
P20-125-012S	Mini-Monster® Cannulated, Short Thread Screw, Headed, 2.5 x 12 mm



Not all products available for sale in all markets. To determine availability in your marketplace, please contact your local Paragon 28 representative or email info@paragon28.com.

3.0 MINI-MONSTER® SCREWS AND INSTRUMENTATION

PART NUMBER	DESCRIPTION
P20-125-013S	Mini-Monster® Cannulated, Short Thread Screw, Headed, 2.5 x 13 mm
P20-125-014S	Mini-Monster® Cannulated, Short Thread Screw, Headed, 2.5 x 14 mm
P20-125-015S	Mini-Monster® Cannulated, Short Thread Screw, Headed, 2.5 x 15 mm
P20-125-016S	Mini-Monster® Cannulated, Short Thread Screw, Headed, 2.5 x 16 mm
P20-125-017S	Mini-Monster® Cannulated, Short Thread Screw, Headed, 2.5 x 17 mm
P20-125-018S	Mini-Monster® Cannulated, Short Thread Screw, Headed, 2.5 x 18 mm
P20-125-019S	Mini-Monster® Cannulated, Short Thread Screw, Headed, 2.5 x 19 mm
P20-125-020S	Mini-Monster® Cannulated, Short Thread Screw, Headed, 2.5 x 20 mm
P20-125-022S	Mini-Monster® Cannulated, Short Thread Screw, Headed, 2.5 x 22 mm
P20-125-024S	Mini-Monster® Cannulated, Short Thread Screw, Headed, 2.5 x 24 mm
P20-125-026S	Mini-Monster® Cannulated, Short Thread Screw, Headed, 2.5 x 26 mm
P20-125-028S	Mini-Monster® Cannulated, Short Thread Screw, Headed, 2.5 x 28 mm
P20-125-030S	Mini-Monster® Cannulated, Short Thread Screw, Headed, 2.5 x 30 mm
P20-125-032S	Mini-Monster® Cannulated, Short Thread Screw, Headed, 2.5 x 32 mm
P20-125-034S	Mini-Monster® Cannulated, Short Thread Screw, Headed, 2.5 x 34 mm
P20-125-036S	Mini-Monster® Cannulated, Short Thread Screw, Headed, 2.5 x 36 mm
P20-125-038S	Mini-Monster® Cannulated, Short Thread Screw, Headed, 2.5 x 38 mm
P20-125-040S	Mini-Monster® Cannulated, Short Thread Screw, Headed, 2.5 x 40 mm
P20-125-042S	Mini-Monster® Cannulated, Short Thread Screw, Headed, 2.5 x 42 mm
P20-125-044S	Mini-Monster® Cannulated, Short Thread Screw, Headed, 2.5 x 44 mm
P20-125-046S	Mini-Monster® Cannulated, Short Thread Screw, Headed, 2.5 x 46 mm
P20-125-048S	Mini-Monster® Cannulated, Short Thread Screw, Headed, 2.5 x 48 mm
P20-125-050S	Mini-Monster® Cannulated, Short Thread Screw, Headed, 2.5 x 50 mm
P20-025-DW00	Mini-Monster® Washer, 2.5 Headed
P20-910-2500	Countersink, 2.5 Headed
P20-915-2500	Countersink, 2.5 Headless
P20-920-2500	Tap, 2.5
P20-941-2025	Tissue Protector, Drill, 2.0 & 2.5
P20-942-2500	Tissue Protector, Overdrill, 2.5
P20-951-2040	Depth Gauge (2.0 - 4.0 mm)
P99-110-1712	Drill, Cannulated, 1.7 X 110 mm
P99-110-2511	Overdrill, Cannulated, 2.5 X 110 mm
P99-150-0001	Screw Forceps
P99-190-TX06	Modified Tx-6 Screw Driver Attachment, Cannulated
P99-191-TX06	Modified Hx6 X 83mm Solid Driver
P99-192-0915	K-Wire, Single Ended Trocar Tip, Smooth, 0.9 X 150 mm
P99-292-0915	K-Wire, Double Ended Trocar Tip, Smooth, 0.9 X 150 mm



Not all products available for sale in all markets. To determine availability in your marketplace, please contact your local Paragon 28 representative or email info@paragon28.com.



3.0 mm Headed and Headless
Mini-Monster® Screws

3.0 MINI-MONSTER® SCREWS AND INSTRUMENTATION

PART NUMBER	DESCRIPTION
P20-900-0017-1	Caddy, Mini Monster, 3.0mm Lag Screw, Base
P20-900-0017-2	Caddy, Mini Monster, 3.0mm Lag Screw, Lid
P20-900-0017-3	Caddy, Mini Monster, 3.0mm Lag Screw, Instrument Base
P20-900-MLID	Caddy, Mini Monster, Instrument Lid
P20-530-010S	Mini-Monster® Headless, Short Thread, 3.0 x 10mm
P20-530-012S	Mini-Monster® Headless, Short Thread, 3.0 x 12mm
P20-530-014S	Mini-Monster® Headless, Short Thread, 3.0 x 14mm
P20-530-016S	Mini-Monster® Headless, Short Thread, 3.0 x 16mm
P20-530-018S	Mini-Monster® Headless, Short Thread, 3.0 x 18mm
P20-530-020S	Mini-Monster® Headless, Short Thread, 3.0 x 20mm
P20-530-022S	Mini-Monster® Headless, Short Thread, 3.0 x 22mm
P20-530-024S	Mini-Monster® Headless, Short Thread, 3.0 x 24mm
P20-530-026S	Mini-Monster® Headless, Short Thread, 3.0 x 26mm
P20-530-028S	Mini-Monster® Headless, Short Thread, 3.0 x 28mm
P20-530-030S	Mini-Monster® Headless, Short Thread, 3.0 x 30mm
P20-530-032S	Mini-Monster® Headless, Short Thread, 3.0 x 32mm
P20-530-034S	Mini-Monster® Headless, Short Thread, 3.0 x 34mm
P20-530-036S	Mini-Monster® Headless, Short Thread, 3.0 x 36mm
P20-530-038S	Mini-Monster® Headless, Short Thread, 3.0 x 38mm
P20-530-040S	Mini-Monster® Headless, Short Thread, 3.0 x 40mm
P20-530-042S	Mini-Monster® Headless, Short Thread, 3.0 x 42mm
P20-530-044S	Mini-Monster® Headless, Short Thread, 3.0 x 44mm
P20-530-046S	Mini-Monster® Headless, Short Thread, 3.0 x 46mm
P20-530-048S	Mini-Monster® Headless, Short Thread, 3.0 x 48mm
P20-530-050S	Mini-Monster® Headless, Short Thread, 3.0 x 50mm
P20-130-010F	Mini-Monster® Headed, Full Thread, 3.0 x 10mm
P20-130-012F	Mini-Monster® Headed, Full Thread, 3.0 x 12mm
P20-130-014F	Mini-Monster® Headed, Full Thread, 3.0 x 14mm
P20-130-016F	Mini-Monster® Headed, Full Thread, 3.0 x 16mm
P20-130-018F	Mini-Monster® Headed, Full Thread, 3.0 x 18mm

Not all products available for sale in all markets. To determine availability in your marketplace, please contact your local Paragon 28 representative or email info@paragon28.com.

3.0 MINI-MONSTER® SCREWS AND INSTRUMENTATION

PART NUMBER	DESCRIPTION
P20-130-020F	Mini-Monster® Headed, Full Thread, 3.0 x 20mm
P20-130-022F	Mini-Monster® Headed, Full Thread, 3.0 x 22mm
P20-130-024F	Mini-Monster® Headed, Full Thread, 3.0 x 24mm
P20-130-026F	Mini-Monster® Headed, Full Thread, 3.0 x 26mm
P20-130-028F	Mini-Monster® Headed, Full Thread, 3.0 x 28mm
P20-130-030F	Mini-Monster® Headed, Full Thread, 3.0 x 30mm
P20-130-032F	Mini-Monster® Headed, Full Thread, 3.0 x 32mm
P20-130-034F	Mini-Monster® Headed, Full Thread, 3.0 x 34mm
P20-130-036F	Mini-Monster® Headed, Full Thread, 3.0 x 36mm
P20-130-038F	Mini-Monster® Headed, Full Thread, 3.0 x 38mm
P20-130-040F	Mini-Monster® Headed, Full Thread, 3.0 x 40mm
P20-130-042F	Mini-Monster® Headed, Full Thread, 3.0 x 42mm
P20-130-044F	Mini-Monster® Headed, Full Thread, 3.0 x 44mm
P20-130-046F	Mini-Monster® Headed, Full Thread, 3.0 x 46mm
P20-130-048F	Mini-Monster® Headed, Full Thread, 3.0 x 48mm
P20-130-050F	Mini-Monster® Headed, Full Thread, 3.0 x 50mm
P20-130-010S	Mini-Monster® Headed, Short Thread, 3.0 x 10mm
P20-130-012S	Mini-Monster® Headed, Short Thread, 3.0 x 12mm
P20-130-014S	Mini-Monster® Headed, Short Thread, 3.0 x 14mm
P20-130-016S	Mini-Monster® Headed, Short Thread, 3.0 x 16mm
P20-130-018S	Mini-Monster® Headed, Short Thread, 3.0 x 18mm
P20-130-020S	Mini-Monster® Headed, Short Thread, 3.0 x 20mm
P20-130-022S	Mini-Monster® Headed, Short Thread, 3.0 x 22mm
P20-130-024S	Mini-Monster® Headed, Short Thread, 3.0 x 24mm
P20-130-026S	Mini-Monster® Headed, Short Thread, 3.0 x 26mm
P20-130-028S	Mini-Monster® Headed, Short Thread, 3.0 x 28mm
P20-130-030S	Mini-Monster® Headed, Short Thread, 3.0 x 30mm
P20-130-032S	Mini-Monster® Headed, Short Thread, 3.0 x 32mm
P20-130-034S	Mini-Monster® Headed, Short Thread, 3.0 x 34mm
P20-130-036S	Mini-Monster® Headed, Short Thread, 3.0 x 36mm
P20-130-038S	Mini-Monster® Headed, Short Thread, 3.0 x 38mm
P20-130-040S	Mini-Monster® Headed, Short Thread, 3.0 x 40mm
P20-130-042S	Mini-Monster® Headed, Short Thread, 3.0 x 42mm
P20-130-044S	Mini-Monster® Headed, Short Thread, 3.0 x 44mm
P20-130-046S	Mini-Monster® Headed, Short Thread, 3.0 x 46mm
P20-130-048S	Mini-Monster® Headed, Short Thread, 3.0 x 48mm
P20-130-050S	Mini-Monster® Headed, Short Thread, 3.0 x 50mm
P20-030-DW00	3.0 Flat Washer, Mini-Monster®
P20-910-3000	Countersink, 3.0 Headed
P20-915-3000	Countersink, 3.0 Headless

Not all products available for sale in all markets. To determine availability in your marketplace, please contact your local Paragon 28 representative or email info@paragon28.com.

3.0 MINI-MONSTER® SCREWS AND INSTRUMENTATION

PART NUMBER	DESCRIPTION
P20-920-3000	Tap, 3.0
P20-941-3000	Tissue Protector, Drill, 3.0
P20-942-3000	Tissue Protector, Overdrill, 3.0
P20-951-2040	Depth Gauge (2.0 - 4.0 mm)
P99-110-2112	Drill, 2.1 X 120 mm Long, Cannulated, A/O (3.0 Mimo)
P99-110-3011	Drill, 3.0 X 110 mm Long, Cannulated, A/O, Overdrill, (3.0 Mimo)
P99-150-0001	Screw Forceps
P99-190-TT08	Screw Driver Attachment, Cannulated, Modified Tx-8
P99-192-1115	K-Wire, Single Ended Trocar Tip, Smooth, 1.1 X 150 mm
P99-292-1115	K-Wire, Double Ended Trocar Tip, Smooth, 1.1 X 150 mm



Not all products available for sale in all markets. To determine availability in your marketplace, please contact your local Paragon 28 representative or email info@paragon28.com.

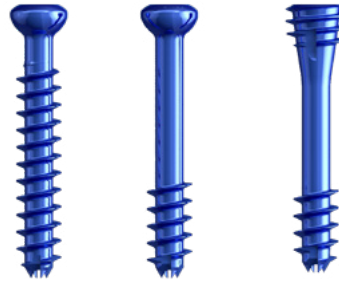

3.5 mm Headed and Headless
Mini-Monster® Screws

3.5 MINI-MONSTER® SCREWS AND INSTRUMENTATION

PART NUMBER	DESCRIPTION
P20-900-0013-1	Caddy, Mini Monster, 3.5mm Lag Screw, Base
P20-900-0013-2	Caddy, Mini Monster, 3.5mm Lag Screw, Lid
P20-900-0013-3	Caddy, Mini Monster, 3.5mm Lag Screw, Instrument Base
P20-900-MLID	Caddy, Mini Monster, Instrument Lid
P20-535-012S	Mini-Monster® Cannulated, Short Thread Screw, Headless, 3.5 x 12 mm
P20-535-014S	Mini-Monster® Cannulated, Short Thread Screw, Headless, 3.5 x 14 mm
P20-535-016S	Mini-Monster® Cannulated, Short Thread Screw, Headless, 3.5 x 16 mm
P20-535-018S	Mini-Monster® Cannulated, Short Thread Screw, Headless, 3.5 x 18 mm
P20-535-020S	Mini-Monster® Cannulated, Short Thread Screw, Headless, 3.5 x 20 mm
P20-535-022S	Mini-Monster® Cannulated, Short Thread Screw, Headless, 3.5 x 22 mm
P20-535-024S	Mini-Monster® Cannulated, Short Thread Screw, Headless, 3.5 x 24 mm
P20-535-026S	Mini-Monster® Cannulated, Short Thread Screw, Headless, 3.5 x 26 mm
P20-535-028S	Mini-Monster® Cannulated, Short Thread Screw, Headless, 3.5 x 28 mm
P20-535-030S	Mini-Monster® Cannulated, Short Thread Screw, Headless, 3.5 x 30 mm
P20-535-032S	Mini-Monster® Cannulated, Short Thread Screw, Headless, 3.5 x 32 mm
P20-535-034S	Mini-Monster® Cannulated, Short Thread Screw, Headless, 3.5 x 34 mm
P20-535-036S	Mini-Monster® Cannulated, Short Thread Screw, Headless, 3.5 x 36 mm
P20-535-038S	Mini-Monster® Cannulated, Short Thread Screw, Headless, 3.5 x 38 mm
P20-535-040S	Mini-Monster® Cannulated, Short Thread Screw, Headless, 3.5 x 40 mm
P20-535-042S	Mini-Monster® Cannulated, Short Thread Screw, Headless, 3.5 x 42 mm
P20-535-044S	Mini-Monster® Cannulated, Short Thread Screw, Headless, 3.5 x 44 mm
P20-535-046S	Mini-Monster® Cannulated, Short Thread Screw, Headless, 3.5 x 46 mm
P20-535-048S	Mini-Monster® Cannulated, Short Thread Screw, Headless, 3.5 x 48 mm
P20-535-050S	Mini-Monster® Cannulated, Short Thread Screw, Headless, 3.5 x 50 mm
P20-135-010F	Mini-Monster® Cannulated, Full Thread Screw, Headed, 3.5 x 10 mm
P20-135-012F	Mini-Monster® Cannulated, Full Thread Screw, Headed, 3.5 x 12 mm
P20-135-014F	Mini-Monster® Cannulated, Full Thread Screw, Headed, 3.5 x 14 mm
P20-135-016F	Mini-Monster® Cannulated, Full Thread Screw, Headed, 3.5 x 16 mm
P20-135-018F	Mini-Monster® Cannulated, Full Thread Screw, Headed, 3.5 x 18 mm
P20-135-020F	Mini-Monster® Cannulated, Full Thread Screw, Headed, 3.5 x 20 mm

Not all products available for sale in all markets. To determine availability in your marketplace, please contact your local Paragon 28 representative or email info@paragon28.com.

3.5 MINI-MONSTER® SCREWS AND INSTRUMENTATION

PART NUMBER	DESCRIPTION
P20-135-022F	Mini-Monster® Cannulated, Full Thread Screw, Headed, 3.5 x 22 mm
P20-135-024F	Mini-Monster® Cannulated, Full Thread Screw, Headed, 3.5 x 24 mm
P20-135-026F	Mini-Monster® Cannulated, Full Thread Screw, Headed, 3.5 x 26 mm
P20-135-028F	Mini-Monster® Cannulated, Full Thread Screw, Headed, 3.5 x 28 mm
P20-135-030F	Mini-Monster® Cannulated, Full Thread Screw, Headed, 3.5 x 30 mm
P20-135-032F	Mini-Monster® Cannulated, Full Thread Screw, Headed, 3.5 x 32 mm
P20-135-034F	Mini-Monster® Cannulated, Full Thread Screw, Headed, 3.5 x 34 mm
P20-135-036F	Mini-Monster® Cannulated, Full Thread Screw, Headed, 3.5 x 36 mm
P20-135-038F	Mini-Monster® Cannulated, Full Thread Screw, Headed, 3.5 x 38 mm
P20-135-040F	Mini-Monster® Cannulated, Full Thread Screw, Headed, 3.5 x 40 mm
P20-135-042F	Mini-Monster® Cannulated, Full Thread Screw, Headed, 3.5 x 42 mm
P20-135-044F	Mini-Monster® Cannulated, Full Thread Screw, Headed, 3.5 x 44 mm
P20-135-046F	Mini-Monster® Cannulated, Full Thread Screw, Headed, 3.5 x 46 mm
P20-135-048F	Mini-Monster® Cannulated, Full Thread Screw, Headed, 3.5 x 48 mm
P20-135-050F	Mini-Monster® Cannulated, Full Thread Screw, Headed, 3.5 x 50 mm
P20-135-010S	Mini-Monster® Cannulated, Short Thread Screw, Headed, 3.5 x 10 mm
P20-135-012S	Mini-Monster® Cannulated, Short Thread Screw, Headed, 3.5 x 12 mm
P20-135-014S	Mini-Monster® Cannulated, Short Thread Screw, Headed, 3.5 x 14 mm
P20-135-016S	Mini-Monster® Cannulated, Short Thread Screw, Headed, 3.5 x 16 mm
P20-135-018S	Mini-Monster® Cannulated, Short Thread Screw, Headed, 3.5 x 18 mm
P20-135-020S	Mini-Monster® Cannulated, Short Thread Screw, Headed, 3.5 x 20 mm
P20-135-022S	Mini-Monster® Cannulated, Short Thread Screw, Headed, 3.5 x 22 mm
P20-135-024S	Mini-Monster® Cannulated, Short Thread Screw, Headed, 3.5 x 24 mm
P20-135-026S	Mini-Monster® Cannulated, Short Thread Screw, Headed, 3.5 x 26 mm
P20-135-028S	Mini-Monster® Cannulated, Short Thread Screw, Headed, 3.5 x 28 mm
P20-135-030S	Mini-Monster® Cannulated, Short Thread Screw, Headed, 3.5 x 30 mm
P20-135-032S	Mini-Monster® Cannulated, Short Thread Screw, Headed, 3.5 x 32 mm
P20-135-034S	Mini-Monster® Cannulated, Short Thread Screw, Headed, 3.5 x 34 mm
P20-135-036S	Mini-Monster® Cannulated, Short Thread Screw, Headed, 3.5 x 36 mm
P20-135-038S	Mini-Monster® Cannulated, Short Thread Screw, Headed, 3.5 x 38 mm
P20-135-040S	Mini-Monster® Cannulated, Short Thread Screw, Headed, 3.5 x 40 mm
P20-135-042S	Mini-Monster® Cannulated, Short Thread Screw, Headed, 3.5 x 42 mm
P20-135-044S	Mini-Monster® Cannulated, Short Thread Screw, Headed, 3.5 x 44 mm
P20-135-046S	Mini-Monster® Cannulated, Short Thread Screw, Headed, 3.5 x 46 mm
P20-135-048S	Mini-Monster® Cannulated, Short Thread Screw, Headed, 3.5 x 48 mm
P20-135-050S	Mini-Monster® Cannulated, Short Thread Screw, Headed, 3.5 x 50 mm
P20-035-DW00	Mini-Monster® Washer, 3.5 Headed
P20-910-3500	Countersink, 3.5 Headed
P20-915-3500	Countersink, 3.5 Headless
P20-920-3500	Tap, 3.5

Not all products available for sale in all markets. To determine availability in your marketplace, please contact your local Paragon 28 representative or email info@paragon28.com.

3.5 MINI-MONSTER® SCREWS AND INSTRUMENTATION

PART NUMBER	DESCRIPTION
P20-941-3500	Tissue Protector, Drill, 3.5
P20-942-3500	Tissue Protector, Overdrill, 3.5
P20-951-2040	Depth Gauge (2.0 - 4.0mm)
P99-110-2312	Drill, Cannulated, 2.3 X 120mm
P99-110-3511	Overdrill, Cannulated, 3.5 X 110mm
P99-150-0001	Screw Forceps
P99-190-TT10	Screw Driver Attachment, Cannulated, Ao, Tx-10
P99-192-1215	K-Wire, Single Ended Trocar Tip, Smooth, 1.2 X 150mm



Not all products available for sale in all markets. To determine availability in your marketplace, please contact your local Paragon 28 representative or email info@paragon28.com.



4.0 mm Headed and Headless
Mini-Monster® Screws

4.0 MINI-MONSTER® SCREWS AND INSTRUMENTATION

PART NUMBER	DESCRIPTION
P20-900-0014-1	Caddy, Mini Monster, 4.0mm Lag Screw, Base
P20-900-0014-2	Caddy, Mini Monster, 4.0mm Lag Screw, Lid
P20-900-0014-3	Caddy, Mini Monster, 4.0mm Lag Screw, Instrument Base
P20-900-MLID	Caddy, Mini Monster, Instrument Lid
P20-540-028L	Mini-Monster® Cannulated, Long Thread Screw, Headless, 4.0 x 28 mm
P20-540-030L	Mini-Monster® Cannulated, Long Thread Screw, Headless, 4.0 x 30 mm
P20-540-032L	Mini-Monster® Cannulated, Long Thread Screw, Headless, 4.0 x 32 mm
P20-540-034L	Mini-Monster® Cannulated, Long Thread Screw, Headless, 4.0 x 34 mm
P20-540-036L	Mini-Monster® Cannulated, Long Thread Screw, Headless, 4.0 x 36 mm
P20-540-038L	Mini-Monster® Cannulated, Long Thread Screw, Headless, 4.0 x 38 mm
P20-540-040L	Mini-Monster® Cannulated, Long Thread Screw, Headless, 4.0 x 40 mm
P20-540-042L	Mini-Monster® Cannulated, Long Thread Screw, Headless, 4.0 x 42 mm
P20-540-044L	Mini-Monster® Cannulated, Long Thread Screw, Headless, 4.0 x 44 mm
P20-540-046L	Mini-Monster® Cannulated, Long Thread Screw, Headless, 4.0 x 46 mm
P20-540-048L	Mini-Monster® Cannulated, Long Thread Screw, Headless, 4.0 x 48 mm
P20-540-050L	Mini-Monster® Cannulated, Long Thread Screw, Headless, 4.0 x 50 mm
P20-540-055L	Mini-Monster® Cannulated, Long Thread Screw, Headless, 4.0 x 55 mm
P20-540-060L	Mini-Monster® Cannulated, Long Thread Screw, Headless, 4.0 x 60 mm
P20-540-014S	Mini-Monster® Cannulated, Short Thread Screw, Headless, 4.0 x 14 mm
P20-540-016S	Mini-Monster® Cannulated, Short Thread Screw, Headless, 4.0 x 16 mm
P20-540-018S	Mini-Monster® Cannulated, Short Thread Screw, Headless, 4.0 x 18 mm
P20-540-020S	Mini-Monster® Cannulated, Short Thread Screw, Headless, 4.0 x 20 mm
P20-540-022S	Mini-Monster® Cannulated, Short Thread Screw, Headless, 4.0 x 22 mm
P20-540-024S	Mini-Monster® Cannulated, Short Thread Screw, Headless, 4.0 x 24 mm
P20-540-026S	Mini-Monster® Cannulated, Short Thread Screw, Headless, 4.0 x 26 mm
P20-540-028S	Mini-Monster® Cannulated, Short Thread Screw, Headless, 4.0 x 28 mm
P20-540-030S	Mini-Monster® Cannulated, Short Thread Screw, Headless, 4.0 x 30 mm
P20-540-032S	Mini-Monster® Cannulated, Short Thread Screw, Headless, 4.0 x 32 mm
P20-540-034S	Mini-Monster® Cannulated, Short Thread Screw, Headless, 4.0 x 34 mm
P20-540-036S	Mini-Monster® Cannulated, Short Thread Screw, Headless, 4.0 x 36 mm

Not all products available for sale in all markets. To determine availability in your marketplace, please contact your local Paragon 28 representative or email info@paragon28.com.

4.0 MINI-MONSTER® SCREWS AND INSTRUMENTATION

PART NUMBER	DESCRIPTION
P20-540-038S	Mini-Monster® Cannulated, Short Thread Screw, Headless, 4.0 x 38 mm
P20-540-040S	Mini-Monster® Cannulated, Short Thread Screw, Headless, 4.0 x 40 mm
P20-540-042S	Mini-Monster® Cannulated, Short Thread Screw, Headless, 4.0 x 42 mm
P20-540-044S	Mini-Monster® Cannulated, Short Thread Screw, Headless, 4.0 x 44 mm
P20-540-046S	Mini-Monster® Cannulated, Short Thread Screw, Headless, 4.0 x 46 mm
P20-540-048S	Mini-Monster® Cannulated, Short Thread Screw, Headless, 4.0 x 48 mm
P20-540-050S	Mini-Monster® Cannulated, Short Thread Screw, Headless, 4.0 x 50 mm
P20-540-055S	Mini-Monster® Cannulated, Short Thread Screw, Headless, 4.0 x 55 mm
P20-540-060S	Mini-Monster® Cannulated, Short Thread Screw, Headless, 4.0 x 60 mm
P20-140-012F	Mini-Monster® Cannulated, Full Thread Screw, Headed, 4.0 x 12 mm
P20-140-014F	Mini-Monster® Cannulated, Full Thread Screw, Headed, 4.0 x 14 mm
P20-140-016F	Mini-Monster® Cannulated, Full Thread Screw, Headed, 4.0 x 16 mm
P20-140-018F	Mini-Monster® Cannulated, Full Thread Screw, Headed, 4.0 x 18 mm
P20-140-020F	Mini-Monster® Cannulated, Full Thread Screw, Headed, 4.0 x 20 mm
P20-140-022F	Mini-Monster® Cannulated, Full Thread Screw, Headed, 4.0 x 22 mm
P20-140-024F	Mini-Monster® Cannulated, Full Thread Screw, Headed, 4.0 x 24 mm
P20-140-026F	Mini-Monster® Cannulated, Full Thread Screw, Headed, 4.0 x 26 mm
P20-140-028F	Mini-Monster® Cannulated, Full Thread Screw, Headed, 4.0 x 28 mm
P20-140-030F	Mini-Monster® Cannulated, Full Thread Screw, Headed, 4.0 x 30 mm
P20-140-032F	Mini-Monster® Cannulated, Full Thread Screw, Headed, 4.0 x 32 mm
P20-140-034F	Mini-Monster® Cannulated, Full Thread Screw, Headed, 4.0 x 34 mm
P20-140-036F	Mini-Monster® Cannulated, Full Thread Screw, Headed, 4.0 x 36 mm
P20-140-038F	Mini-Monster® Cannulated, Full Thread Screw, Headed, 4.0 x 38 mm
P20-140-040F	Mini-Monster® Cannulated, Full Thread Screw, Headed, 4.0 x 40 mm
P20-140-042F	Mini-Monster® Cannulated, Full Thread Screw, Headed, 4.0 x 42 mm
P20-140-044F	Mini-Monster® Cannulated, Full Thread Screw, Headed, 4.0 x 44 mm
P20-140-046F	Mini-Monster® Cannulated, Full Thread Screw, Headed, 4.0 x 46 mm
P20-140-048F	Mini-Monster® Cannulated, Full Thread Screw, Headed, 4.0 x 48 mm
P20-140-050F	Mini-Monster® Cannulated, Full Thread Screw, Headed, 4.0 x 50 mm
P20-140-055F	Mini-Monster® Cannulated, Full Thread Screw, Headed, 4.0 x 55 mm
P20-140-060F	Mini-Monster® Cannulated, Full Thread Screw, Headed, 4.0 x 60 mm
P20-140-028L	Mini-Monster® Cannulated, Long Thread Screw, Headed, 4.0 x 28 mm
P20-140-030L	Mini-Monster® Cannulated, Long Thread Screw, Headed, 4.0 x 30 mm
P20-140-032L	Mini-Monster® Cannulated, Long Thread Screw, Headed, 4.0 x 32 mm
P20-140-034L	Mini-Monster® Cannulated, Long Thread Screw, Headed, 4.0 x 34 mm
P20-140-036L	Mini-Monster® Cannulated, Long Thread Screw, Headed, 4.0 x 36 mm
P20-140-038L	Mini-Monster® Cannulated, Long Thread Screw, Headed, 4.0 x 38 mm
P20-140-040L	Mini-Monster® Cannulated, Long Thread Screw, Headed, 4.0 x 40 mm
P20-140-042L	Mini-Monster® Cannulated, Long Thread Screw, Headed, 4.0 x 42 mm
P20-140-044L	Mini-Monster® Cannulated, Long Thread Screw, Headed, 4.0 x 44 mm

Not all products available for sale in all markets. To determine availability in your marketplace, please contact your local Paragon 28 representative or email info@paragon28.com.

4.0 MINI-MONSTER® SCREWS AND INSTRUMENTATION

PART NUMBER	DESCRIPTION
P20-140-046L	Mini-Monster® Cannulated, Long Thread Screw, Headed, 4.0 x 46 mm
P20-140-048L	Mini-Monster® Cannulated, Long Thread Screw, Headed, 4.0 x 48 mm
P20-140-050L	Mini-Monster® Cannulated, Long Thread Screw, Headed, 4.0 x 50 mm
P20-140-055L	Mini-Monster® Cannulated, Long Thread Screw, Headed, 4.0 x 55 mm
P20-140-060L	Mini-Monster® Cannulated, Long Thread Screw, Headed, 4.0 x 60 mm
P20-140-012S	Mini-Monster® Cannulated, Short Thread Screw, Headed, 4.0 x 12 mm
P20-140-014S	Mini-Monster® Cannulated, Short Thread Screw, Headed, 4.0 x 14 mm
P20-140-016S	Mini-Monster® Cannulated, Short Thread Screw, Headed, 4.0 x 16 mm
P20-140-018S	Mini-Monster® Cannulated, Short Thread Screw, Headed, 4.0 x 18 mm
P20-140-020S	Mini-Monster® Cannulated, Short Thread Screw, Headed, 4.0 x 20 mm
P20-140-022S	Mini-Monster® Cannulated, Short Thread Screw, Headed, 4.0 x 22 mm
P20-140-024S	Mini-Monster® Cannulated, Short Thread Screw, Headed, 4.0 x 24 mm
P20-140-026S	Mini-Monster® Cannulated, Short Thread Screw, Headed, 4.0 x 26 mm
P20-140-028S	Mini-Monster® Cannulated, Short Thread Screw, Headed, 4.0 x 28 mm
P20-140-030S	Mini-Monster® Cannulated, Short Thread Screw, Headed, 4.0 x 30 mm
P20-140-032S	Mini-Monster® Cannulated, Short Thread Screw, Headed, 4.0 x 32 mm
P20-140-034S	Mini-Monster® Cannulated, Short Thread Screw, Headed, 4.0 x 34 mm
P20-140-036S	Mini-Monster® Cannulated, Short Thread Screw, Headed, 4.0 x 36 mm
P20-140-038S	Mini-Monster® Cannulated, Short Thread Screw, Headed, 4.0 x 38 mm
P20-140-040S	Mini-Monster® Cannulated, Short Thread Screw, Headed, 4.0 x 40 mm
P20-140-042S	Mini-Monster® Cannulated, Short Thread Screw, Headed, 4.0 x 42 mm
P20-140-044S	Mini-Monster® Cannulated, Short Thread Screw, Headed, 4.0 x 44 mm
P20-140-046S	Mini-Monster® Cannulated, Short Thread Screw, Headed, 4.0 x 46 mm
P20-140-048S	Mini-Monster® Cannulated, Short Thread Screw, Headed, 4.0 x 48 mm
P20-140-050S	Mini-Monster® Cannulated, Short Thread Screw, Headed, 4.0 x 50 mm
P20-140-055S	Mini-Monster® Cannulated, Short Thread Screw, Headed, 4.0 x 55 mm
P20-140-060S	Mini-Monster® Cannulated, Short Thread Screw, Headed, 4.0 x 60 mm
P20-040-DW00	Mini-Monster® Washer, 4.0 Headed
P20-910-4000	Countersink, 4.0 Headed
P20-915-4000	Countersink, 4.0 Headless
P20-920-4000	Tap, 4.0
P20-941-4000	Tissue Protector, Drill, 4.0
P20-942-4000	Tissue Protector, Overdrill, 4.0
P20-951-2040	Depth Gauge (2.0 - 4.0 mm)
P99-110-2613	Drill, Cannulated, 2.6 X 130 mm
P99-110-4011	Overdrill, Cannulated, 4.0 X 110 mm
P99-150-0001	Screw Forceps
P99-190-TT10	Screw Driver Attachment, Cannulated, Ao, Tx-10
P99-192-1215	K-Wire, Single Ended Trocar Tip, Smooth, 1.2 X 150 mm



Not all products available for sale in all markets. To determine availability in your marketplace, please contact your local Paragon 28 representative or email info@paragon28.com.

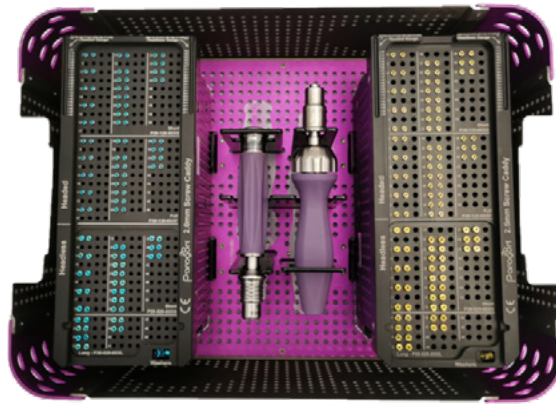

MINI-MONSTER® TWO PACK TRAY

PART NUMBER	DESCRIPTION
P20-900-0018	Case Base, Mini Monster
P20-900-0019	Case Lid, Mini Monster
P99-000-AOMN	Ratchet Handle, Mini Axial AO Pull Adapter
P99-000-AOSS	Handle, Non-Rtch, Streamline Short, AO Pull, Cannulated



MINI-MONSTER® FIVE PACK TRAY

PART NUMBER	DESCRIPTION
P20-900-0001	Case Lid
P20-900-0031	Case Base Outer, Mini Monster Full Din
P20-900-0032	Case Tray, Mini Monster, Full Din
P99-000-AOMN	P99-000-AOMN
P99-000-AOSS	Mini Ao, Non Ratcheting Handle Streamline, Cannulated
P99-900-1005	P28 Foot Plate, Plantigrade Guide

Not all products available for sale in all markets. To determine availability in your marketplace, please contact your local Paragon 28 representative or email info@paragon28.com.

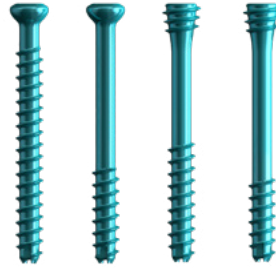

2.0 mm Headed and Headless
Mini-Monster® Screws

2.0 MINI-MONSTER® SCREWS AND INSTRUMENTATION (STAINLESS STEEL CADDY)

PART NUMBER	DESCRIPTION
P20-901-0015	International Stainless Steel Caddy, Mini-Monster®, 2.0mm Lag Screw
P20-520-030L	Mini-Monster® Headless, Long Thread, 2.0 x 30mm
P20-520-032L	Mini-Monster® Headless, Long Thread, 2.0 x 32mm
P20-520-034L	Mini-Monster® Headless, Long Thread, 2.0 x 34mm
P20-520-036L	Mini-Monster® Headless, Long Thread, 2.0 x 36mm
P20-520-038L	Mini-Monster® Headless, Long Thread, 2.0 x 38mm
P20-520-040L	Mini-Monster® Headless, Long Thread, 2.0 x 40mm
P20-520-010S	Mini-Monster® Headless, Short Thread, 2.0 x 10mm
P20-520-012S	Mini-Monster® Headless, Short Thread, 2.0 x 12mm
P20-520-014S	Mini-Monster® Headless, Short Thread, 2.0 x 14mm
P20-520-016S	Mini-Monster® Headless, Short Thread, 2.0 x 16mm
P20-520-018S	Mini-Monster® Headless, Short Thread, 2.0 x 18mm
P20-520-020S	Mini-Monster® Headless, Short Thread, 2.0 x 20mm
P20-520-022S	Mini-Monster® Headless, Short Thread, 2.0 x 22mm
P20-520-024S	Mini-Monster® Headless, Short Thread, 2.0 x 24mm
P20-520-026S	Mini-Monster® Headless, Short Thread, 2.0 x 26mm
P20-520-028S	Mini-Monster® Headless, Short Thread, 2.0 x 28mm
P20-520-030S	Mini-Monster® Headless, Short Thread, 2.0 x 30mm
P20-520-032S	Mini-Monster® Headless, Short Thread, 2.0 x 32mm
P20-520-034S	Mini-Monster® Headless, Short Thread, 2.0 x 34mm
P20-520-036S	Mini-Monster® Headless, Short Thread, 2.0 x 36mm
P20-520-038S	Mini-Monster® Headless, Short Thread, 2.0 x 38mm
P20-520-040S	Mini-Monster® Headless, Short Thread, 2.0 x 40mm
P20-120-008F	Mini-Monster® Headed, Full Thread, 2.0 x 8mm
P20-120-010F	Mini-Monster® Headed, Full Thread, 2.0 x 10mm
P20-120-012F	Mini-Monster® Headed, Full Thread, 2.0 x 12mm
P20-120-014F	Mini-Monster® Headed, Full Thread, 2.0 x 14mm
P20-120-016F	Mini-Monster® Headed, Full Thread, 2.0 x 16mm
P20-120-018F	Mini-Monster® Headed, Full Thread, 2.0 x 18mm
P20-120-020F	Mini-Monster® Headed, Full Thread, 2.0 x 20mm

Not all products available for sale in all markets. To determine availability in your marketplace, please contact your local Paragon 28 representative or email info@paragon28.com.

2.0 MINI-MONSTER® SCREWS AND INSTRUMENTATION (STAINLESS STEEL CADDY)

PART NUMBER	DESCRIPTION
P20-120-022F	Mini-Monster® Headed, Full Thread, 2.0 x 22mm
P20-120-024F	Mini-Monster® Headed, Full Thread, 2.0 x 24mm
P20-120-026F	Mini-Monster® Headed, Full Thread, 2.0 x 26mm
P20-120-028F	Mini-Monster® Headed, Full Thread, 2.0 x 28mm
P20-120-030F	Mini-Monster® Headed, Full Thread, 2.0 x 30mm
P20-120-032F	Mini-Monster® Headed, Full Thread, 2.0 x 32mm
P20-120-034F	Mini-Monster® Headed, Full Thread, 2.0 x 34mm
P20-120-036F	Mini-Monster® Headed, Full Thread, 2.0 x 36mm
P20-120-038F	Mini-Monster® Headed, Full Thread, 2.0 x 38mm
P20-120-040F	Mini-Monster® Headed, Full Thread, 2.0 x 40mm
P20-120-008S	Mini-Monster® Headed, Short Thread, 2.0 x 8mm
P20-120-010S	Mini-Monster® Headed, Short Thread, 2.0 x 10mm
P20-120-012S	Mini-Monster® Headed, Short Thread, 2.0 x 12mm
P20-120-014S	Mini-Monster® Headed, Short Thread, 2.0 x 14mm
P20-120-016S	Mini-Monster® Headed, Short Thread, 2.0 x 16mm
P20-120-018S	Mini-Monster® Headed, Short Thread, 2.0 x 18mm
P20-120-020S	Mini-Monster® Headed, Short Thread, 2.0 x 20mm
P20-120-022S	Mini-Monster® Headed, Short Thread, 2.0 x 22mm
P20-120-024S	Mini-Monster® Headed, Short Thread, 2.0 x 24mm
P20-120-026S	Mini-Monster® Headed, Short Thread, 2.0 x 26mm
P20-120-028S	Mini-Monster® Headed, Short Thread, 2.0 x 28mm
P20-120-030S	Mini-Monster® Headed, Short Thread, 2.0 x 30mm
P20-120-032S	Mini-Monster® Headed, Short Thread, 2.0 x 32mm
P20-120-034S	Mini-Monster® Headed, Short Thread, 2.0 x 34mm
P20-120-036S	Mini-Monster® Headed, Short Thread, 2.0 x 36mm
P20-120-038S	Mini-Monster® Headed, Short Thread, 2.0 x 38mm
P20-120-040S	Mini-Monster® Headed, Short Thread, 2.0 x 40mm
P20-020-DW00	2.0 Deep Well Washer, Mini-Monster®
P20-910-2000	Countersink, 2.0 Headed
P20-915-2000	Countersink, 2.0 Headless
P20-941-2025	Tissue Protector, Drill, 2.0 & 2.5
P20-942-2000	Tissue Protector, Overdrill, 2.0
P20-951-2040	Depth Gauge (2.0 - 4.0 mm)
P99-110-1712	Drill, Cannulated, 1.7 X 110 mm
P99-110-2011	Overdrill, Cannulated, 2.0 X 110 mm
P99-150-0001	Screw Forceps
P99-190-TX06	Modified Tx-6 Screw Driver Attachment, Cannulated
P99-191-TX06	Modified Hx6 X 83mm Solid Driver
P99-192-0915	K-Wire, Single Ended Trocar Tip, Smooth, 0.9 X 150 mm
P99-292-0915	K-Wire, Double Ended Trocar Tip, Smooth, 0.9 X 150 mm

JUMP TO MINI-MONSTER 2.0
STERILE PACKAGED PRODUCT



Not all products available for sale in all markets. To determine availability in your marketplace, please contact your local Paragon 28 representative or email info@paragon28.com.



2.5 mm Headed and Headless Mini-Monster® Screws

2.5 MINI-MONSTER® SCREWS AND INSTRUMENTATION (STAINLESS STEEL CADDY)

PART NUMBER	DESCRIPTION
P20-900-0016	Caddy, Mini Monster, 2.5mm Lag Screw
P20-525-030L	Mini-Monster Cannulated, Long Thread Screw, Headless, 2.5 X 30 mm
P20-525-032L	Mini-Monster Cannulated, Long Thread Screw, Headless, 2.5 X 32 mm
P20-525-034L	Mini-Monster Cannulated, Long Thread Screw, Headless, 2.5 X 34 mm
P20-525-036L	Mini-Monster Cannulated, Long Thread Screw, Headless, 2.5 X 36 mm
P20-525-038L	Mini-Monster Cannulated, Long Thread Screw, Headless, 2.5 X 38 mm
P20-525-040L	Mini-Monster Cannulated, Long Thread Screw, Headless, 2.5 X 40 mm
P20-525-010S	Mini-Monster Cannulated, Short Thread Screw, Headless, 2.5 X 10 mm
P20-525-012S	Mini-Monster Cannulated, Short Thread Screw, Headless, 2.5 X 12 mm
P20-525-014S	Mini-Monster Cannulated, Short Thread Screw, Headless, 2.5 X 14 mm
P20-525-016S	Mini-Monster Cannulated, Short Thread Screw, Headless, 2.5 X 16 mm
P20-525-018S	Mini-Monster Cannulated, Short Thread Screw, Headless, 2.5 X 18 mm
P20-525-020S	Mini-Monster Cannulated, Short Thread Screw, Headless, 2.5 X 20 mm
P20-525-022S	Mini-Monster Cannulated, Short Thread Screw, Headless, 2.5 X 22 mm
P20-525-024S	Mini-Monster Cannulated, Short Thread Screw, Headless, 2.5 X 24 mm
P20-525-026S	Mini-Monster Cannulated, Short Thread Screw, Headless, 2.5 X 26 mm
P20-525-028S	Mini-Monster Cannulated, Short Thread Screw, Headless, 2.5 X 28 mm
P20-525-030S	Mini-Monster Cannulated, Short Thread Screw, Headless, 2.5 X 30 mm
P20-525-032S	Mini-Monster Cannulated, Short Thread Screw, Headless, 2.5 X 32 mm
P20-525-034S	Mini-Monster Cannulated, Short Thread Screw, Headless, 2.5 X 34 mm
P20-525-036S	Mini-Monster Cannulated, Short Thread Screw, Headless, 2.5 X 36 mm
P20-525-038S	Mini-Monster Cannulated, Short Thread Screw, Headless, 2.5 X 38 mm
P20-525-040S	Mini-Monster Cannulated, Short Thread Screw, Headless, 2.5 X 40 mm
P20-125-010F	Mini-Monster Cannulated, Full Thread Screw, Headed, 2.5 X 10 mm
P20-125-012F	Mini-Monster Cannulated, Full Thread Screw, Headed, 2.5 X 12 mm
P20-125-014F	Mini-Monster Cannulated, Full Thread Screw, Headed, 2.5 X 14 mm
P20-125-016F	Mini-Monster Cannulated, Full Thread Screw, Headed, 2.5 X 16 mm
P20-125-018F	Mini-Monster Cannulated, Full Thread Screw, Headed, 2.5 X 18 mm
P20-125-020F	Mini-Monster Cannulated, Full Thread Screw, Headed, 2.5 X 20 mm
P20-125-022F	Mini-Monster Cannulated, Full Thread Screw, Headed, 2.5 X 22 mm

Not all products available for sale in all markets. To determine availability in your marketplace, please contact your local Paragon 28 representative or email info@paragon28.com.

2.5 MINI-MONSTER® SCREWS AND INSTRUMENTATION (STAINLESS STEEL CADDY)

PART NUMBER	DESCRIPTION
P20-125-024F	Mini-Monster Cannulated, Full Thread Screw, Headed, 2.5 X 24 mm
P20-125-026F	Mini-Monster Cannulated, Full Thread Screw, Headed, 2.5 X 26 mm
P20-125-028F	Mini-Monster Cannulated, Full Thread Screw, Headed, 2.5 X 28 mm
P20-125-030F	Mini-Monster Cannulated, Full Thread Screw, Headed, 2.5 X 30 mm
P20-125-032F	Mini-Monster Cannulated, Full Thread Screw, Headed, 2.5 X 32 mm
P20-125-034F	Mini-Monster Cannulated, Full Thread Screw, Headed, 2.5 X 34 mm
P20-125-036F	Mini-Monster Cannulated, Full Thread Screw, Headed, 2.5 X 36 mm
P20-125-038F	Mini-Monster Cannulated, Full Thread Screw, Headed, 2.5 X 38 mm
P20-125-040F	Mini-Monster Cannulated, Full Thread Screw, Headed, 2.5 X 40 mm
P20-125-010S	Mini-Monster Cannulated, Short Thread Screw, Headed, 2.5 X 10 mm
P20-125-012S	Mini-Monster Cannulated, Short Thread Screw, Headed, 2.5 X 12 mm
P20-125-014S	Mini-Monster Cannulated, Short Thread Screw, Headed, 2.5 X 14 mm
P20-125-016S	Mini-Monster Cannulated, Short Thread Screw, Headed, 2.5 X 16 mm
P20-125-018S	Mini-Monster Cannulated, Short Thread Screw, Headed, 2.5 X 18 mm
P20-125-020S	Mini-Monster Cannulated, Short Thread Screw, Headed, 2.5 X 20 mm
P20-125-022S	Mini-Monster Cannulated, Short Thread Screw, Headed, 2.5 X 22 mm
P20-125-024S	Mini-Monster Cannulated, Short Thread Screw, Headed, 2.5 X 24 mm
P20-125-026S	Mini-Monster Cannulated, Short Thread Screw, Headed, 2.5 X 26 mm
P20-125-028S	Mini-Monster Cannulated, Short Thread Screw, Headed, 2.5 X 28 mm
P20-125-030S	Mini-Monster Cannulated, Short Thread Screw, Headed, 2.5 X 30 mm
P20-125-032S	Mini-Monster Cannulated, Short Thread Screw, Headed, 2.5 X 32 mm
P20-125-034S	Mini-Monster Cannulated, Short Thread Screw, Headed, 2.5 X 34 mm
P20-125-036S	Mini-Monster Cannulated, Short Thread Screw, Headed, 2.5 X 36 mm
P20-125-038S	Mini-Monster Cannulated, Short Thread Screw, Headed, 2.5 X 38 mm
P20-125-040S	Mini-Monster Cannulated, Short Thread Screw, Headed, 2.5 X 40 mm
P20-025-DW00	Mini-Monster Washer, 2.5 Headed
P20-910-2500	Countersink, 2.5 Headed
P20-915-2500	Countersink, 2.5 Headless
P20-920-2500	Tap, 2.5
P20-941-2025	Tissue Protector, Drill, 2.0 & 2.5
P20-942-2500	Tissue Protector, Overdrill, 2.5
P20-951-2040	Depth Gauge (2.0 - 4.0 mm)
P99-110-1712	Drill, Cannulated, 1.7 X 110 mm
P99-110-2511	Overdrill, Cannulated, 2.5 X 110 mm
P99-150-0001	Screw Forceps
P99-190-TX06	Modified Tx-6 Screw Driver Attachment, Cannulated
P99-191-TX06	Modified Hx6 X 83mm Solid Driver
P99-192-0915	K-Wire, Single Ended Trocar Tip, Smooth, 0.9 X 150 mm
P99-292-0915	K-Wire, Double Ended Trocar Tip, Smooth, 0.9 X 150 mm



Not all products available for sale in all markets. To determine availability in your marketplace, please contact your local Paragon 28 representative or email info@paragon28.com.



3.0 mm Headed and Headless
Mini-Monster® Screws

3.0 MINI-MONSTER® SCREWS AND INSTRUMENTATION (STAINLESS STEEL CADDY)

PART NUMBER	DESCRIPTION
P20-900-0017	CADDY, Mini-Monster®, 3.0mm LAG SCREW
P20-530-010S	Mini-Monster® Headless, Short Thread, 3.0 x 10mm
P20-530-012S	Mini-Monster® Headless, Short Thread, 3.0 x 12mm
P20-530-014S	Mini-Monster® Headless, Short Thread, 3.0 x 14mm
P20-530-016S	Mini-Monster® Headless, Short Thread, 3.0 x 16mm
P20-530-018S	Mini-Monster® Headless, Short Thread, 3.0 x 18mm
P20-530-020S	Mini-Monster® Headless, Short Thread, 3.0 x 20mm
P20-530-022S	Mini-Monster® Headless, Short Thread, 3.0 x 22mm
P20-530-024S	Mini-Monster® Headless, Short Thread, 3.0 x 24mm
P20-530-026S	Mini-Monster® Headless, Short Thread, 3.0 x 26mm
P20-530-028S	Mini-Monster® Headless, Short Thread, 3.0 x 28mm
P20-530-030S	Mini-Monster® Headless, Short Thread, 3.0 x 30mm
P20-530-032S	Mini-Monster® Headless, Short Thread, 3.0 x 32mm
P20-530-034S	Mini-Monster® Headless, Short Thread, 3.0 x 34mm
P20-530-036S	Mini-Monster® Headless, Short Thread, 3.0 x 36mm
P20-530-038S	Mini-Monster® Headless, Short Thread, 3.0 x 38mm
P20-530-040S	Mini-Monster® Headless, Short Thread, 3.0 x 40mm
P20-530-042S	Mini-Monster® Headless, Short Thread, 3.0 x 42mm
P20-530-044S	Mini-Monster® Headless, Short Thread, 3.0 x 44mm
P20-530-046S	Mini-Monster® Headless, Short Thread, 3.0 x 46mm
P20-530-048S	Mini-Monster® Headless, Short Thread, 3.0 x 48mm
P20-530-050S	Mini-Monster® Headless, Short Thread, 3.0 x 50mm
P20-130-010F	Mini-Monster® Headed, Full Thread, 3.0 x 10mm
P20-130-012F	Mini-Monster® Headed, Full Thread, 3.0 x 12mm
P20-130-014F	Mini-Monster® Headed, Full Thread, 3.0 x 14mm
P20-130-016F	Mini-Monster® Headed, Full Thread, 3.0 x 16mm
P20-130-018F	Mini-Monster® Headed, Full Thread, 3.0 x 18mm
P20-130-020F	Mini-Monster® Headed, Full Thread, 3.0 x 20mm
P20-130-022F	Mini-Monster® Headed, Full Thread, 3.0 x 22mm
P20-130-024F	Mini-Monster® Headed, Full Thread, 3.0 x 24mm

Not all products available for sale in all markets. To determine availability in your marketplace, please contact your local Paragon 28 representative or email info@paragon28.com.

3.0 MINI-MONSTER® SCREWS AND INSTRUMENTATION (STAINLESS STEEL CADDY)

PART NUMBER	DESCRIPTION
P20-130-026F	Mini-Monster® Headed, Full Thread, 3.0 x 26mm
P20-130-028F	Mini-Monster® Headed, Full Thread, 3.0 x 28mm
P20-130-030F	Mini-Monster® Headed, Full Thread, 3.0 x 30mm
P20-130-032F	Mini-Monster® Headed, Full Thread, 3.0 x 32mm
P20-130-034F	Mini-Monster® Headed, Full Thread, 3.0 x 34mm
P20-130-036F	Mini-Monster® Headed, Full Thread, 3.0 x 36mm
P20-130-038F	Mini-Monster® Headed, Full Thread, 3.0 x 38mm
P20-130-040F	Mini-Monster® Headed, Full Thread, 3.0 x 40mm
P20-130-042F	Mini-Monster® Headed, Full Thread, 3.0 x 42mm
P20-130-044F	Mini-Monster® Headed, Full Thread, 3.0 x 44mm
P20-130-046F	Mini-Monster® Headed, Full Thread, 3.0 x 46mm
P20-130-048F	Mini-Monster® Headed, Full Thread, 3.0 x 48mm
P20-130-050F	Mini-Monster® Headed, Full Thread, 3.0 x 50mm
P20-130-010S	Mini-Monster® Headed, Short Thread, 3.0 x 10mm
P20-130-012S	Mini-Monster® Headed, Short Thread, 3.0 x 12mm
P20-130-014S	Mini-Monster® Headed, Short Thread, 3.0 x 14mm
P20-130-016S	Mini-Monster® Headed, Short Thread, 3.0 x 16mm
P20-130-018S	Mini-Monster® Headed, Short Thread, 3.0 x 18mm
P20-130-020S	Mini-Monster® Headed, Short Thread, 3.0 x 20mm
P20-130-022S	Mini-Monster® Headed, Short Thread, 3.0 x 22mm
P20-130-024S	Mini-Monster® Headed, Short Thread, 3.0 x 24mm
P20-130-026S	Mini-Monster® Headed, Short Thread, 3.0 x 26mm
P20-130-028S	Mini-Monster® Headed, Short Thread, 3.0 x 28mm
P20-130-030S	Mini-Monster® Headed, Short Thread, 3.0 x 30mm
P20-130-032S	Mini-Monster® Headed, Short Thread, 3.0 x 32mm
P20-130-034S	Mini-Monster® Headed, Short Thread, 3.0 x 34mm
P20-130-036S	Mini-Monster® Headed, Short Thread, 3.0 x 36mm
P20-130-038S	Mini-Monster® Headed, Short Thread, 3.0 x 38mm
P20-130-040S	Mini-Monster® Headed, Short Thread, 3.0 x 40mm
P20-130-042S	Mini-Monster® Headed, Short Thread, 3.0 x 42mm
P20-130-044S	Mini-Monster® Headed, Short Thread, 3.0 x 44mm
P20-130-046S	Mini-Monster® Headed, Short Thread, 3.0 x 46mm
P20-130-048S	Mini-Monster® Headed, Short Thread, 3.0 x 48mm
P20-130-050S	Mini-Monster® Headed, Short Thread, 3.0 x 50mm
P20-030-DW00	3.0 Flat Washer, Mini-Monster®
P20-910-3000	Countersink, 3.0 Headed
P20-915-3000	Countersink, 3.0 Headless
P20-920-3000	Tap, 3.0
P20-941-3000	Tissue Protector, Drill, 3.0
P20-942-3000	Tissue Protector, Overdrill, 3.0

Not all products available for sale in all markets. To determine availability in your marketplace, please contact your local Paragon 28 representative or email info@paragon28.com.

3.0 MINI-MONSTER® SCREWS AND INSTRUMENTATION (STAINLESS STEEL CADDY)

PART NUMBER	DESCRIPTION
P20-951-2040	Depth Gauge (2.0 - 4.0 mm)
P99-110-2112	Drill, 2.1 X 120 mm Long, Cannulated, A/O (3.0 Mimo)
P99-110-3011	Drill, 3.0 X 110 mm Long, Cannulated, A/O, Overdrill, (3.0 Mimo)
P99-150-0001	Screw Forceps
P99-190-TT08	Screw Driver Attachment, Cannulated, Modified Tx-8
P99-192-1115	K-Wire, Single Ended Trocar Tip, Smooth, 1.1 X 150 mm
P99-292-1115	K-Wire, Double Ended Trocar Tip, Smooth, 1.1 X 150 mm



Not all products available for sale in all markets. To determine availability in your marketplace, please contact your local Paragon 28 representative or email info@paragon28.com.

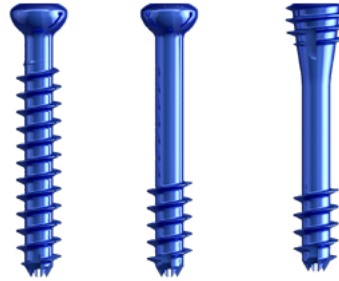

3.5 mm Headed and Headless
Mini-Monster® Screws

3.5 MINI-MONSTER® SCREWS AND INSTRUMENTATION (STAINLESS STEEL CADDY)

PART NUMBER	DESCRIPTION
P20-901-0013	Stainless Steel Mini-Monster® 3.5mm Lag Screw Caddy
P20-535-012S	Mini-Monster® Cannulated, Short Thread Screw, Headless, 3.5 x 12 mm
P20-535-014S	Mini-Monster® Cannulated, Short Thread Screw, Headless, 3.5 x 14 mm
P20-535-016S	Mini-Monster® Cannulated, Short Thread Screw, Headless, 3.5 x 16 mm
P20-535-018S	Mini-Monster® Cannulated, Short Thread Screw, Headless, 3.5 x 18 mm
P20-535-020S	Mini-Monster® Cannulated, Short Thread Screw, Headless, 3.5 x 20 mm
P20-535-022S	Mini-Monster® Cannulated, Short Thread Screw, Headless, 3.5 x 22 mm
P20-535-024S	Mini-Monster® Cannulated, Short Thread Screw, Headless, 3.5 x 24 mm
P20-535-026S	Mini-Monster® Cannulated, Short Thread Screw, Headless, 3.5 x 26 mm
P20-535-028S	Mini-Monster® Cannulated, Short Thread Screw, Headless, 3.5 x 28 mm
P20-535-030S	Mini-Monster® Cannulated, Short Thread Screw, Headless, 3.5 x 30 mm
P20-535-032S	Mini-Monster® Cannulated, Short Thread Screw, Headless, 3.5 x 32 mm
P20-535-034S	Mini-Monster® Cannulated, Short Thread Screw, Headless, 3.5 x 34 mm
P20-535-036S	Mini-Monster® Cannulated, Short Thread Screw, Headless, 3.5 x 36 mm
P20-535-038S	Mini-Monster® Cannulated, Short Thread Screw, Headless, 3.5 x 38 mm
P20-535-040S	Mini-Monster® Cannulated, Short Thread Screw, Headless, 3.5 x 40 mm
P20-535-042S	Mini-Monster® Cannulated, Short Thread Screw, Headless, 3.5 x 42 mm
P20-535-044S	Mini-Monster® Cannulated, Short Thread Screw, Headless, 3.5 x 44 mm
P20-535-046S	Mini-Monster® Cannulated, Short Thread Screw, Headless, 3.5 x 46 mm
P20-535-048S	Mini-Monster® Cannulated, Short Thread Screw, Headless, 3.5 x 48 mm
P20-535-050S	Mini-Monster® Cannulated, Short Thread Screw, Headless, 3.5 x 50 mm
P20-135-010F	Mini-Monster® Cannulated, Full Thread Screw, Headed, 3.5 x 10 mm
P20-135-012F	Mini-Monster® Cannulated, Full Thread Screw, Headed, 3.5 x 12 mm
P20-135-014F	Mini-Monster® Cannulated, Full Thread Screw, Headed, 3.5 x 14 mm
P20-135-016F	Mini-Monster® Cannulated, Full Thread Screw, Headed, 3.5 x 16 mm
P20-135-018F	Mini-Monster® Cannulated, Full Thread Screw, Headed, 3.5 x 18 mm
P20-135-020F	Mini-Monster® Cannulated, Full Thread Screw, Headed, 3.5 x 20 mm
P20-135-022F	Mini-Monster® Cannulated, Full Thread Screw, Headed, 3.5 x 22 mm
P20-135-024F	Mini-Monster® Cannulated, Full Thread Screw, Headed, 3.5 x 24 mm
P20-135-026F	Mini-Monster® Cannulated, Full Thread Screw, Headed, 3.5 x 26 mm

Not all products available for sale in all markets. To determine availability in your marketplace, please contact your local Paragon 28 representative or email info@paragon28.com.

3.5 MINI-MONSTER® SCREWS AND INSTRUMENTATION (STAINLESS STEEL CADDY)

PART NUMBER	DESCRIPTION
P20-135-028F	Mini-Monster® Cannulated, Full Thread Screw, Headed, 3.5 x 28 mm
P20-135-030F	Mini-Monster® Cannulated, Full Thread Screw, Headed, 3.5 x 30 mm
P20-135-032F	Mini-Monster® Cannulated, Full Thread Screw, Headed, 3.5 x 32 mm
P20-135-034F	Mini-Monster® Cannulated, Full Thread Screw, Headed, 3.5 x 34 mm
P20-135-036F	Mini-Monster® Cannulated, Full Thread Screw, Headed, 3.5 x 36 mm
P20-135-038F	Mini-Monster® Cannulated, Full Thread Screw, Headed, 3.5 x 38 mm
P20-135-040F	Mini-Monster® Cannulated, Full Thread Screw, Headed, 3.5 x 40 mm
P20-135-042F	Mini-Monster® Cannulated, Full Thread Screw, Headed, 3.5 x 42 mm
P20-135-044F	Mini-Monster® Cannulated, Full Thread Screw, Headed, 3.5 x 44 mm
P20-135-046F	Mini-Monster® Cannulated, Full Thread Screw, Headed, 3.5 x 46 mm
P20-135-048F	Mini-Monster® Cannulated, Full Thread Screw, Headed, 3.5 x 48 mm
P20-135-050F	Mini-Monster® Cannulated, Full Thread Screw, Headed, 3.5 x 50 mm
P20-135-010S	Mini-Monster® Cannulated, Short Thread Screw, Headed, 3.5 x 10 mm
P20-135-012S	Mini-Monster® Cannulated, Short Thread Screw, Headed, 3.5 x 12 mm
P20-135-014S	Mini-Monster® Cannulated, Short Thread Screw, Headed, 3.5 x 14 mm
P20-135-016S	Mini-Monster® Cannulated, Short Thread Screw, Headed, 3.5 x 16 mm
P20-135-018S	Mini-Monster® Cannulated, Short Thread Screw, Headed, 3.5 x 18 mm
P20-135-020S	Mini-Monster® Cannulated, Short Thread Screw, Headed, 3.5 x 20 mm
P20-135-022S	Mini-Monster® Cannulated, Short Thread Screw, Headed, 3.5 x 22 mm
P20-135-024S	Mini-Monster® Cannulated, Short Thread Screw, Headed, 3.5 x 24 mm
P20-135-026S	Mini-Monster® Cannulated, Short Thread Screw, Headed, 3.5 x 26 mm
P20-135-028S	Mini-Monster® Cannulated, Short Thread Screw, Headed, 3.5 x 28 mm
P20-135-030S	Mini-Monster® Cannulated, Short Thread Screw, Headed, 3.5 x 30 mm
P20-135-032S	Mini-Monster® Cannulated, Short Thread Screw, Headed, 3.5 x 32 mm
P20-135-034S	Mini-Monster® Cannulated, Short Thread Screw, Headed, 3.5 x 34 mm
P20-135-036S	Mini-Monster® Cannulated, Short Thread Screw, Headed, 3.5 x 36 mm
P20-135-038S	Mini-Monster® Cannulated, Short Thread Screw, Headed, 3.5 x 38 mm
P20-135-040S	Mini-Monster® Cannulated, Short Thread Screw, Headed, 3.5 x 40 mm
P20-135-042S	Mini-Monster® Cannulated, Short Thread Screw, Headed, 3.5 x 42 mm
P20-135-044S	Mini-Monster® Cannulated, Short Thread Screw, Headed, 3.5 x 44 mm
P20-135-046S	Mini-Monster® Cannulated, Short Thread Screw, Headed, 3.5 x 46 mm
P20-135-048S	Mini-Monster® Cannulated, Short Thread Screw, Headed, 3.5 x 48 mm
P20-135-050S	Mini-Monster® Cannulated, Short Thread Screw, Headed, 3.5 x 50 mm
P20-035-DW00	Mini-Monster® Washer, 3.5 headed
P20-910-3500	Countersink, 3.5 headed
P20-915-3500	Countersink, 3.5 headless
P20-920-3500	Tap, 3.5
P20-941-3500	Tissue Protector, Drill, 3.5
P20-942-3500	Tissue Protector, Overdrill, 3.5
P20-951-2040	Depth Gauge (2.0 - 4.0mm)

Not all products available for sale in all markets. To determine availability in your marketplace, please contact your local Paragon 28 representative or email info@paragon28.com.

3.5 MINI-MONSTER® SCREWS AND INSTRUMENTATION (STAINLESS STEEL CADDY)

PART NUMBER	DESCRIPTION
P99-110-2312	Drill, Cannulated, 2.3 x 120mm
P99-110-3511	Overdrill, Cannulated, 3.5 x 110mm
P99-150-0001	Screw Forceps
P99-190-TT10	Screw driver attachment, cannulated, AO, TX-10
P99-192-1215	K-Wire, Single Ended Trocar Tip, Smooth, 1.2 x 150mm



Not all products available for sale in all markets. To determine availability in your marketplace, please contact your local Paragon 28 representative or email info@paragon28.com.



4.0 mm Headed and Headless
Mini-Monster® Screws

4.0 MINI-MONSTER® SCREWS AND INSTRUMENTATION (STAINLESS STEEL CADDY)

PART NUMBER	DESCRIPTION
P20-901-0014	Stainless Steel Mini-Monster® 4.0mm LAG SCREW CADDY
P20-540-028L	Mini-Monster® Cannulated, Long Thread Screw, Headless, 4.0 x 28 mm
P20-540-030L	Mini-Monster® Cannulated, Long Thread Screw, Headless, 4.0 x 30 mm
P20-540-032L	Mini-Monster® Cannulated, Long Thread Screw, Headless, 4.0 x 32 mm
P20-540-034L	Mini-Monster® Cannulated, Long Thread Screw, Headless, 4.0 x 34 mm
P20-540-036L	Mini-Monster® Cannulated, Long Thread Screw, Headless, 4.0 x 36 mm
P20-540-038L	Mini-Monster® Cannulated, Long Thread Screw, Headless, 4.0 x 38 mm
P20-540-040L	Mini-Monster® Cannulated, Long Thread Screw, Headless, 4.0 x 40 mm
P20-540-042L	Mini-Monster® Cannulated, Long Thread Screw, Headless, 4.0 x 42 mm
P20-540-044L	Mini-Monster® Cannulated, Long Thread Screw, Headless, 4.0 x 44 mm
P20-540-046L	Mini-Monster® Cannulated, Long Thread Screw, Headless, 4.0 x 46 mm
P20-540-048L	Mini-Monster® Cannulated, Long Thread Screw, Headless, 4.0 x 48 mm
P20-540-050L	Mini-Monster® Cannulated, Long Thread Screw, Headless, 4.0 x 50 mm
P20-540-055L	Mini-Monster® Cannulated, Long Thread Screw, Headless, 4.0 x 55 mm
P20-540-060L	Mini-Monster® Cannulated, Long Thread Screw, Headless, 4.0 x 60 mm
P20-540-014S	Mini-Monster® Cannulated, Short Thread Screw, Headless, 4.0 x 14 mm
P20-540-016S	Mini-Monster® Cannulated, Short Thread Screw, Headless, 4.0 x 16 mm
P20-540-018S	Mini-Monster® Cannulated, Short Thread Screw, Headless, 4.0 x 18 mm
P20-540-020S	Mini-Monster® Cannulated, Short Thread Screw, Headless, 4.0 x 20 mm
P20-540-022S	Mini-Monster® Cannulated, Short Thread Screw, Headless, 4.0 x 22 mm
P20-540-024S	Mini-Monster® Cannulated, Short Thread Screw, Headless, 4.0 x 24 mm
P20-540-026S	Mini-Monster® Cannulated, Short Thread Screw, Headless, 4.0 x 26 mm
P20-540-028S	Mini-Monster® Cannulated, Short Thread Screw, Headless, 4.0 x 28 mm
P20-540-030S	Mini-Monster® Cannulated, Short Thread Screw, Headless, 4.0 x 30 mm
P20-540-032S	Mini-Monster® Cannulated, Short Thread Screw, Headless, 4.0 x 32 mm
P20-540-034S	Mini-Monster® Cannulated, Short Thread Screw, Headless, 4.0 x 34 mm
P20-540-036S	Mini-Monster® Cannulated, Short Thread Screw, Headless, 4.0 x 36 mm
P20-540-038S	Mini-Monster® Cannulated, Short Thread Screw, Headless, 4.0 x 38 mm
P20-540-040S	Mini-Monster® Cannulated, Short Thread Screw, Headless, 4.0 x 40 mm
P20-540-042S	Mini-Monster® Cannulated, Short Thread Screw, Headless, 4.0 x 42 mm

Not all products available for sale in all markets. To determine availability in your marketplace, please contact your local Paragon 28 representative or email info@paragon28.com.

4.0 MINI-MONSTER® SCREWS AND INSTRUMENTATION (STAINLESS STEEL CADDY)

PART NUMBER	DESCRIPTION
P20-540-044S	Mini-Monster® Cannulated, Short Thread Screw, Headless, 4.0 x 44 mm
P20-540-046S	Mini-Monster® Cannulated, Short Thread Screw, Headless, 4.0 x 46 mm
P20-540-048S	Mini-Monster® Cannulated, Short Thread Screw, Headless, 4.0 x 48 mm
P20-540-050S	Mini-Monster® Cannulated, Short Thread Screw, Headless, 4.0 x 50 mm
P20-540-055S	Mini-Monster® Cannulated, Short Thread Screw, Headless, 4.0 x 55 mm
P20-540-060S	Mini-Monster® Cannulated, Short Thread Screw, Headless, 4.0 x 60 mm
P20-140-012F	Mini-Monster® Cannulated, Full Thread Screw, Headed, 4.0 x 12 mm
P20-140-014F	Mini-Monster® Cannulated, Full Thread Screw, Headed, 4.0 x 14 mm
P20-140-016F	Mini-Monster® Cannulated, Full Thread Screw, Headed, 4.0 x 16 mm
P20-140-018F	Mini-Monster® Cannulated, Full Thread Screw, Headed, 4.0 x 18 mm
P20-140-020F	Mini-Monster® Cannulated, Full Thread Screw, Headed, 4.0 x 20 mm
P20-140-022F	Mini-Monster® Cannulated, Full Thread Screw, Headed, 4.0 x 22 mm
P20-140-024F	Mini-Monster® Cannulated, Full Thread Screw, Headed, 4.0 x 24 mm
P20-140-026F	Mini-Monster® Cannulated, Full Thread Screw, Headed, 4.0 x 26 mm
P20-140-028F	Mini-Monster® Cannulated, Full Thread Screw, Headed, 4.0 x 28 mm
P20-140-030F	Mini-Monster® Cannulated, Full Thread Screw, Headed, 4.0 x 30 mm
P20-140-032F	Mini-Monster® Cannulated, Full Thread Screw, Headed, 4.0 x 32 mm
P20-140-034F	Mini-Monster® Cannulated, Full Thread Screw, Headed, 4.0 x 34 mm
P20-140-036F	Mini-Monster® Cannulated, Full Thread Screw, Headed, 4.0 x 36 mm
P20-140-038F	Mini-Monster® Cannulated, Full Thread Screw, Headed, 4.0 x 38 mm
P20-140-040F	Mini-Monster® Cannulated, Full Thread Screw, Headed, 4.0 x 40 mm
P20-140-042F	Mini-Monster® Cannulated, Full Thread Screw, Headed, 4.0 x 42 mm
P20-140-044F	Mini-Monster® Cannulated, Full Thread Screw, Headed, 4.0 x 44 mm
P20-140-046F	Mini-Monster® Cannulated, Full Thread Screw, Headed, 4.0 x 46 mm
P20-140-048F	Mini-Monster® Cannulated, Full Thread Screw, Headed, 4.0 x 48 mm
P20-140-050F	Mini-Monster® Cannulated, Full Thread Screw, Headed, 4.0 x 50 mm
P20-140-055F	Mini-Monster® Cannulated, Full Thread Screw, Headed, 4.0 x 55 mm
P20-140-060F	Mini-Monster® Cannulated, Full Thread Screw, Headed, 4.0 x 60 mm
P20-140-028L	Mini-Monster® Cannulated, Long Thread Screw, Headed, 4.0 x 28 mm
P20-140-030L	Mini-Monster® Cannulated, Long Thread Screw, Headed, 4.0 x 30 mm
P20-140-032L	Mini-Monster® Cannulated, Long Thread Screw, Headed, 4.0 x 32 mm
P20-140-034L	Mini-Monster® Cannulated, Long Thread Screw, Headed, 4.0 x 34 mm
P20-140-036L	Mini-Monster® Cannulated, Long Thread Screw, Headed, 4.0 x 36 mm
P20-140-038L	Mini-Monster® Cannulated, Long Thread Screw, Headed, 4.0 x 38 mm
P20-140-040L	Mini-Monster® Cannulated, Long Thread Screw, Headed, 4.0 x 40 mm
P20-140-042L	Mini-Monster® Cannulated, Long Thread Screw, Headed, 4.0 x 42 mm
P20-140-044L	Mini-Monster® Cannulated, Long Thread Screw, Headed, 4.0 x 44 mm
P20-140-046L	Mini-Monster® Cannulated, Long Thread Screw, Headed, 4.0 x 46 mm
P20-140-048L	Mini-Monster® Cannulated, Long Thread Screw, Headed, 4.0 x 48 mm
P20-140-050L	Mini-Monster® Cannulated, Long Thread Screw, Headed, 4.0 x 50 mm

Not all products available for sale in all markets. To determine availability in your marketplace, please contact your local Paragon 28 representative or email info@paragon28.com.

4.0 MINI-MONSTER® SCREWS AND INSTRUMENTATION (STAINLESS STEEL CADDY)

PART NUMBER	DESCRIPTION
P20-140-055L	Mini-Monster® Cannulated, Long Thread Screw, Headed, 4.0 x 55 mm
P20-140-060L	Mini-Monster® Cannulated, Long Thread Screw, Headed, 4.0 x 60 mm
P20-140-012S	Mini-Monster® Cannulated, Short Thread Screw, Headed, 4.0 x 12 mm
P20-140-014S	Mini-Monster® Cannulated, Short Thread Screw, Headed, 4.0 x 14 mm
P20-140-016S	Mini-Monster® Cannulated, Short Thread Screw, Headed, 4.0 x 16 mm
P20-140-018S	Mini-Monster® Cannulated, Short Thread Screw, Headed, 4.0 x 18 mm
P20-140-020S	Mini-Monster® Cannulated, Short Thread Screw, Headed, 4.0 x 20 mm
P20-140-022S	Mini-Monster® Cannulated, Short Thread Screw, Headed, 4.0 x 22 mm
P20-140-024S	Mini-Monster® Cannulated, Short Thread Screw, Headed, 4.0 x 24 mm
P20-140-026S	Mini-Monster® Cannulated, Short Thread Screw, Headed, 4.0 x 26 mm
P20-140-028S	Mini-Monster® Cannulated, Short Thread Screw, Headed, 4.0 x 28 mm
P20-140-030S	Mini-Monster® Cannulated, Short Thread Screw, Headed, 4.0 x 30 mm
P20-140-032S	Mini-Monster® Cannulated, Short Thread Screw, Headed, 4.0 x 32 mm
P20-140-034S	Mini-Monster® Cannulated, Short Thread Screw, Headed, 4.0 x 34 mm
P20-140-036S	Mini-Monster® Cannulated, Short Thread Screw, Headed, 4.0 x 36 mm
P20-140-038S	Mini-Monster® Cannulated, Short Thread Screw, Headed, 4.0 x 38 mm
P20-140-040S	Mini-Monster® Cannulated, Short Thread Screw, Headed, 4.0 x 40 mm
P20-140-042S	Mini-Monster® Cannulated, Short Thread Screw, Headed, 4.0 x 42 mm
P20-140-044S	Mini-Monster® Cannulated, Short Thread Screw, Headed, 4.0 x 44 mm
P20-140-046S	Mini-Monster® Cannulated, Short Thread Screw, Headed, 4.0 x 46 mm
P20-140-048S	Mini-Monster® Cannulated, Short Thread Screw, Headed, 4.0 x 48 mm
P20-140-050S	Mini-Monster® Cannulated, Short Thread Screw, Headed, 4.0 x 50 mm
P20-140-055S	Mini-Monster® Cannulated, Short Thread Screw, Headed, 4.0 x 55 mm
P20-140-060S	Mini-Monster® Cannulated, Short Thread Screw, Headed, 4.0 x 60 mm
P20-040-DW00	Mini-Monster® washer, 4.0 headed
P20-910-4000	Countersink, 4.0 Headed
P20-915-4000	Countersink, 4.0 Headless
P20-920-4000	Tap, 4.0
P20-941-4000	Tissue Protector, Drill, 4.0
P20-942-4000	Tissue Protector, Overdrill, 4.0
P20-951-2040	Depth Gauge (2.0 - 4.0 mm)
P99-110-2613	Drill, Cannulated, 2.6 X 130 mm
P99-110-4011	Overdrill, Cannulated, 4.0 X 110 mm
P99-150-0001	Screw Forceps
P99-190-TT10	Screw Driver Attachment, Cannulated, Ao, Tx-10
P99-192-1215	K-Wire, Single Ended Trocar Tip, Smooth, 1.2 X 150 mm



Not all products available for sale in all markets. To determine availability in your marketplace, please contact your local Paragon 28 representative or email info@paragon28.com.

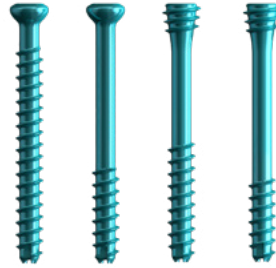

2.0 mm Headed and Headless
Mini-Monster® Screws

INTERNATIONAL 2.0 MINI-MONSTER® SCREWS AND INSTRUMENTATION

PART NUMBER	DESCRIPTION
P20-901-0015	International Stainless Steel Caddy, Mini-Monster®, 2.0mm Lag Screw
P20-520-030L	Mini-Monster® Headless, Long Thread, 2.0 x 30mm
P20-520-032L	Mini-Monster® Headless, Long Thread, 2.0 x 32mm
P20-520-034L	Mini-Monster® Headless, Long Thread, 2.0 x 34mm
P20-520-036L	Mini-Monster® Headless, Long Thread, 2.0 x 36mm
P20-520-038L	Mini-Monster® Headless, Long Thread, 2.0 x 38mm
P20-520-040L	Mini-Monster® Headless, Long Thread, 2.0 x 40mm
P20-520-010S	Mini-Monster® Headless, Short Thread, 2.0 x 10mm
P20-520-012S	Mini-Monster® Headless, Short Thread, 2.0 x 12mm
P20-520-014S	Mini-Monster® Headless, Short Thread, 2.0 x 14mm
P20-520-016S	Mini-Monster® Headless, Short Thread, 2.0 x 16mm
P20-520-018S	Mini-Monster® Headless, Short Thread, 2.0 x 18mm
P20-520-020S	Mini-Monster® Headless, Short Thread, 2.0 x 20mm
P20-520-022S	Mini-Monster® Headless, Short Thread, 2.0 x 22mm
P20-520-024S	Mini-Monster® Headless, Short Thread, 2.0 x 24mm
P20-520-026S	Mini-Monster® Headless, Short Thread, 2.0 x 26mm
P20-520-028S	Mini-Monster® Headless, Short Thread, 2.0 x 28mm
P20-520-030S	Mini-Monster® Headless, Short Thread, 2.0 x 30mm
P20-520-032S	Mini-Monster® Headless, Short Thread, 2.0 x 32mm
P20-520-034S	Mini-Monster® Headless, Short Thread, 2.0 x 34mm
P20-520-036S	Mini-Monster® Headless, Short Thread, 2.0 x 36mm
P20-520-038S	Mini-Monster® Headless, Short Thread, 2.0 x 38mm
P20-520-040S	Mini-Monster® Headless, Short Thread, 2.0 x 40mm
P20-120-008F	Mini-Monster® Headed, Full Thread, 2.0 x 8mm
P20-120-010F	Mini-Monster® Headed, Full Thread, 2.0 x 10mm
P20-120-012F	Mini-Monster® Headed, Full Thread, 2.0 x 12mm
P20-120-014F	Mini-Monster® Headed, Full Thread, 2.0 x 14mm
P20-120-016F	Mini-Monster® Headed, Full Thread, 2.0 x 16mm
P20-120-018F	Mini-Monster® Headed, Full Thread, 2.0 x 18mm
P20-120-020F	Mini-Monster® Headed, Full Thread, 2.0 x 20mm

Not all products available for sale in all markets. To determine availability in your marketplace, please contact your local Paragon 28 representative or email info@paragon28.com.

INTERNATIONAL 2.0 MINI-MONSTER® SCREWS AND INSTRUMENTATION

PART NUMBER	DESCRIPTION
P20-120-022F	Mini-Monster® Headed, Full Thread, 2.0 x 22mm
P20-120-024F	Mini-Monster® Headed, Full Thread, 2.0 x 24mm
P20-120-026F	Mini-Monster® Headed, Full Thread, 2.0 x 26mm
P20-120-028F	Mini-Monster® Headed, Full Thread, 2.0 x 28mm
P20-120-030F	Mini-Monster® Headed, Full Thread, 2.0 x 30mm
P20-120-032F	Mini-Monster® Headed, Full Thread, 2.0 x 32mm
P20-120-034F	Mini-Monster® Headed, Full Thread, 2.0 x 34mm
P20-120-036F	Mini-Monster® Headed, Full Thread, 2.0 x 36mm
P20-120-038F	Mini-Monster® Headed, Full Thread, 2.0 x 38mm
P20-120-040F	Mini-Monster® Headed, Full Thread, 2.0 x 40mm
P20-120-008S	Mini-Monster® Headed, Short Thread, 2.0 x 8mm
P20-120-010S	Mini-Monster® Headed, Short Thread, 2.0 x 10mm
P20-120-012S	Mini-Monster® Headed, Short Thread, 2.0 x 12mm
P20-120-014S	Mini-Monster® Headed, Short Thread, 2.0 x 14mm
P20-120-016S	Mini-Monster® Headed, Short Thread, 2.0 x 16mm
P20-120-018S	Mini-Monster® Headed, Short Thread, 2.0 x 18mm
P20-120-020S	Mini-Monster® Headed, Short Thread, 2.0 x 20mm
P20-120-022S	Mini-Monster® Headed, Short Thread, 2.0 x 22mm
P20-120-024S	Mini-Monster® Headed, Short Thread, 2.0 x 24mm
P20-120-026S	Mini-Monster® Headed, Short Thread, 2.0 x 26mm
P20-120-028S	Mini-Monster® Headed, Short Thread, 2.0 x 28mm
P20-120-030S	Mini-Monster® Headed, Short Thread, 2.0 x 30mm
P20-120-032S	Mini-Monster® Headed, Short Thread, 2.0 x 32mm
P20-120-034S	Mini-Monster® Headed, Short Thread, 2.0 x 34mm
P20-120-036S	Mini-Monster® Headed, Short Thread, 2.0 x 36mm
P20-120-038S	Mini-Monster® Headed, Short Thread, 2.0 x 38mm
P20-120-040S	Mini-Monster® Headed, Short Thread, 2.0 x 40mm
P20-020-DW00	2.0 Deep Well Washer, Mini-Monster®
P20-910-2000	Countersink, 2.0 Headed
P20-915-2000	Countersink, 2.0 Headless
P20-941-2025	Tissue Protector, Drill, 2.0 & 2.5
P20-942-2000	Tissue Protector, Overdrill, 2.0
P20-951-2040	Depth Gauge (2.0 - 4.0 mm)
P99-110-1712	Drill, Cannulated, 1.7 X 110 mm
P99-110-2011	Overdrill, Cannulated, 2.0 X 110 mm
P99-150-0001	Screw Forceps
P99-190-TX06	Modified Tx-6 Screw Driver Attachment, Cannulated
P99-191-TX06	Modified Hx6 X 83mm Solid Driver
P99-192-0915	K-Wire, Single Ended Trocar Tip, Smooth, 0.9 X 150 mm
P99-292-0915	K-Wire, Double Ended Trocar Tip, Smooth, 0.9 X 150 mm

JUMP TO MINI-MONSTER 2.0
STERILE PACKAGED PRODUCT



Not all products available for sale in all markets. To determine availability in your marketplace, please contact your local Paragon 28 representative or email info@paragon28.com.

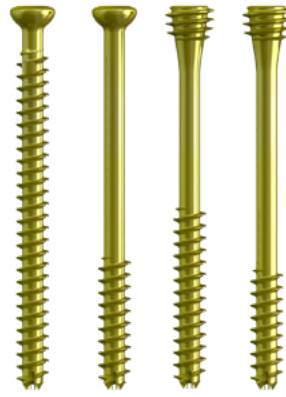

2.5 mm Headed and Headless Mini-Monster® Screws

INTERNATIONAL 2.5 MINI-MONSTER® SCREWS AND INSTRUMENTATION

PART NUMBER	DESCRIPTION
P20-901-0016	International Stainless Steel Caddy, Mini Monster, 2.5mm Lag Screw
P20-525-030L	Mini-Monster® Cannulated, Long Thread Screw, Headless, 2.5 x 30 mm
P20-525-032L	Mini-Monster® Cannulated, Long Thread Screw, Headless, 2.5 x 32 mm
P20-525-034L	Mini-Monster® Cannulated, Long Thread Screw, Headless, 2.5 x 34 mm
P20-525-036L	Mini-Monster® Cannulated, Long Thread Screw, Headless, 2.5 x 36 mm
P20-525-038L	Mini-Monster® Cannulated, Long Thread Screw, Headless, 2.5 x 38 mm
P20-525-040L	Mini-Monster® Cannulated, Long Thread Screw, Headless, 2.5 x 40 mm
P20-525-010S	Mini-Monster® Cannulated, Short Thread Screw, Headless, 2.5 x 10 mm
P20-525-012S	Mini-Monster® Cannulated, Short Thread Screw, Headless, 2.5 x 12 mm
P20-525-014S	Mini-Monster® Cannulated, Short Thread Screw, Headless, 2.5 x 14 mm
P20-525-016S	Mini-Monster® Cannulated, Short Thread Screw, Headless, 2.5 x 16 mm
P20-525-018S	Mini-Monster® Cannulated, Short Thread Screw, Headless, 2.5 x 18 mm
P20-525-020S	Mini-Monster® Cannulated, Short Thread Screw, Headless, 2.5 x 20 mm
P20-525-022S	Mini-Monster® Cannulated, Short Thread Screw, Headless, 2.5 x 22 mm
P20-525-024S	Mini-Monster® Cannulated, Short Thread Screw, Headless, 2.5 x 24 mm
P20-525-026S	Mini-Monster® Cannulated, Short Thread Screw, Headless, 2.5 x 26 mm
P20-525-028S	Mini-Monster® Cannulated, Short Thread Screw, Headless, 2.5 x 28 mm
P20-525-030S	Mini-Monster® Cannulated, Short Thread Screw, Headless, 2.5 x 30 mm
P20-525-032S	Mini-Monster® Cannulated, Short Thread Screw, Headless, 2.5 x 32 mm
P20-525-034S	Mini-Monster® Cannulated, Short Thread Screw, Headless, 2.5 x 34 mm
P20-525-036S	Mini-Monster® Cannulated, Short Thread Screw, Headless, 2.5 x 36 mm
P20-525-038S	Mini-Monster® Cannulated, Short Thread Screw, Headless, 2.5 x 38 mm
P20-525-040S	Mini-Monster® Cannulated, Short Thread Screw, Headless, 2.5 x 40 mm
P20-125-010F	Mini-Monster® Cannulated, Full Thread Screw, Headed, 2.5 x 10 mm
P20-125-012F	Mini-Monster® Cannulated, Full Thread Screw, Headed, 2.5 x 12 mm
P20-125-014F	Mini-Monster® Cannulated, Full Thread Screw, Headed, 2.5 x 14 mm
P20-125-016F	Mini-Monster® Cannulated, Full Thread Screw, Headed, 2.5 x 16 mm
P20-125-018F	Mini-Monster® Cannulated, Full Thread Screw, Headed, 2.5 x 18 mm
P20-125-020F	Mini-Monster® Cannulated, Full Thread Screw, Headed, 2.5 x 20 mm
P20-125-022F	Mini-Monster® Cannulated, Full Thread Screw, Headed, 2.5 x 22 mm

Not all products available for sale in all markets. To determine availability in your marketplace, please contact your local Paragon 28 representative or email info@paragon28.com.

INTERNATIONAL 2.5 MINI-MONSTER® SCREWS AND INSTRUMENTATION

PART NUMBER	DESCRIPTION
P20-125-024F	Mini-Monster® Cannulated, Full Thread Screw, Headed, 2.5 x 24 mm
P20-125-026F	Mini-Monster® Cannulated, Full Thread Screw, Headed, 2.5 x 26 mm
P20-125-028F	Mini-Monster® Cannulated, Full Thread Screw, Headed, 2.5 x 28 mm
P20-125-030F	Mini-Monster® Cannulated, Full Thread Screw, Headed, 2.5 x 30 mm
P20-125-032F	Mini-Monster® Cannulated, Full Thread Screw, Headed, 2.5 x 32 mm
P20-125-034F	Mini-Monster® Cannulated, Full Thread Screw, Headed, 2.5 x 34 mm
P20-125-036F	Mini-Monster® Cannulated, Full Thread Screw, Headed, 2.5 x 36 mm
P20-125-038F	Mini-Monster® Cannulated, Full Thread Screw, Headed, 2.5 x 38 mm
P20-125-040F	Mini-Monster® Cannulated, Full Thread Screw, Headed, 2.5 x 40 mm
P20-125-010S	Mini-Monster® Cannulated, Short Thread Screw, Headed, 2.5 x 10 mm
P20-125-012S	Mini-Monster® Cannulated, Short Thread Screw, Headed, 2.5 x 12 mm
P20-125-014S	Mini-Monster® Cannulated, Short Thread Screw, Headed, 2.5 x 14 mm
P20-125-016S	Mini-Monster® Cannulated, Short Thread Screw, Headed, 2.5 x 16 mm
P20-125-018S	Mini-Monster® Cannulated, Short Thread Screw, Headed, 2.5 x 18 mm
P20-125-020S	Mini-Monster® Cannulated, Short Thread Screw, Headed, 2.5 x 20 mm
P20-125-022S	Mini-Monster® Cannulated, Short Thread Screw, Headed, 2.5 x 22 mm
P20-125-024S	Mini-Monster® Cannulated, Short Thread Screw, Headed, 2.5 x 24 mm
P20-125-026S	Mini-Monster® Cannulated, Short Thread Screw, Headed, 2.5 x 26 mm
P20-125-028S	Mini-Monster® Cannulated, Short Thread Screw, Headed, 2.5 x 28 mm
P20-125-030S	Mini-Monster® Cannulated, Short Thread Screw, Headed, 2.5 x 30 mm
P20-125-032S	Mini-Monster® Cannulated, Short Thread Screw, Headed, 2.5 x 32 mm
P20-125-034S	Mini-Monster® Cannulated, Short Thread Screw, Headed, 2.5 x 34 mm
P20-125-036S	Mini-Monster® Cannulated, Short Thread Screw, Headed, 2.5 x 36 mm
P20-125-038S	Mini-Monster® Cannulated, Short Thread Screw, Headed, 2.5 x 38 mm
P20-125-040S	Mini-Monster® Cannulated, Short Thread Screw, Headed, 2.5 x 40 mm
P20-025-DW00	Mini-Monster® washer, 2.5 headed
P20-910-2500	Countersink, 2.5 Headed
P20-915-2500	Countersink, 2.5 Headless
P20-920-2500	Tap, 2.5
P20-941-2025	Tissue Protector, Drill, 2.0 & 2.5
P20-942-2500	Tissue Protector, Overdrill, 2.5
P20-951-2040	Depth Gauge (2.0 - 4.0 mm)
P99-110-1712	Drill, Cannulated, 1.7 x 110 mm
P99-110-2511	Overdrill, Cannulated, 2.5 x 110 mm
P99-150-0001	Screw Forceps
P99-190-TX06	Modified Tx-6 Screw Driver Attachment, Cannulated
P99-191-TX06	Modified Hx6 x 83mm Solid Driver
P99-192-0915	K-Wire, Single Ended Trocar Tip, Smooth, 0.9 x 150 mm
P99-292-0915	K-Wire, Double Ended Trocar Tip, Smooth, 0.9 x 150 mm

Section 23:

MINI-MONSTER® SOLID SCREW SYSTEM

Not all products available for sale in all markets. To determine availability in your marketplace, please contact your local Paragon 28 representative or email info@paragon28.com.

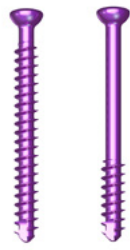

2.7 mm Mini-Monster®
Solid Screws

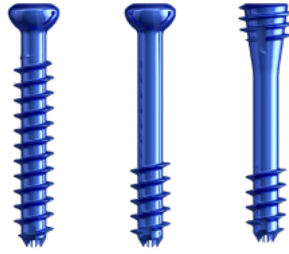

3.5 mm Mini-Monster®
Solid Screws

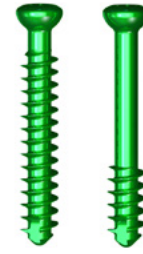

4.0 mm Mini-Monster®
Solid Screws

MINI-MONSTER® SCREWS AND INSTRUMENTATION

PART NUMBER	DESCRIPTION
P20-900-0019	Mini-Monster® solid case lid
P20-900-5001	Mini-Monster® solid case base
P20-900-5002	Mini-Monster® solid case tray
P20-900-5003	Mini-Monster® solid case caddy
P20-900-5007	Mini-Monster Solid Screw, Case Caddy, Lid
P20-900-5004-1	ø0.9mm K-Wire Tube
P20-900-5005-1	ø1.2mm K-Wire Tube
P20-900-5006	K-Wire Tube Cap (5132-4574)
P20-027-DW00	Monster Washer Deep well 2.7mm
P20-035-DW00	Mini-Monster Washer, 3.5 Headed
P20-040-DW00	Mini-Monster Washer, 4.0 Headed
P20-427-010F	Mini-Monster®, Screw, 2.7 x 10mm, Headed, Full Thd, Solid, Blunt Tip, Tia
P20-427-010S	Mini-Monster®, Screw, 2.7 x 10mm, Headed, Short Thd, Solid, Blunt Tip, Tia
P20-427-011F	Mini-Monster®, Screw, 2.7 x 11mm, Headed, Full Thd, Solid, Blunt Tip, Tia
P20-427-011S	Mini-Monster®, Screw, 2.7 x 11mm, Headed, Short Thd, Solid, Blunt Tip, Tia
P20-427-012F	Mini-Monster®, Screw, 2.7 x 12mm, Headed, Full Thd, Solid, Blunt Tip, Tia
P20-427-012S	Mini-Monster®, Screw, 2.7 x 12mm, Headed, Short Thd, Solid, Blunt Tip, Tia
P20-427-013F	Mini-Monster®, Screw, 2.7 x 13mm, Headed, Full Thd, Solid, Blunt Tip, Tia
P20-427-013S	Mini-Monster®, Screw, 2.7 x 13mm, Headed, Short Thd, Solid, Blunt Tip, Tia
P20-427-014F	Mini-Monster®, Screw, 2.7 x 14mm, Headed, Full Thd, Solid, Blunt Tip, Tia
P20-427-014S	Mini-Monster®, Screw, 2.7 x 14mm, Headed, Short Thd, Solid, Blunt Tip, Tia
P20-427-015F	Mini-Monster®, Screw, 2.7 x 15mm, Headed, Full Thd, Solid, Blunt Tip, Tia
P20-427-015S	Mini-Monster®, Screw, 2.7 x 15mm, Headed, Short Thd, Solid, Blunt Tip, Tia
P20-427-016F	Mini-Monster®, Screw, 2.7 x 16mm, Headed, Full Thd, Solid, Blunt Tip, Tia
P20-427-016S	Mini-Monster®, Screw, 2.7 x 16mm, Headed, Short Thd, Solid, Blunt Tip, Tia
P20-427-017F	Mini-Monster®, Screw, 2.7 x 17mm, Headed, Full Thd, Solid, Blunt Tip, Tia
P20-427-017S	Mini-Monster®, Screw, 2.7 x 17mm, Headed, Short Thd, Solid, Blunt Tip, Tia
P20-427-018F	Mini-Monster®, Screw, 2.7 x 18mm, Headed, Full Thd, Solid, Blunt Tip, Tia
P20-427-018S	Mini-Monster®, Screw, 2.7 x 18mm, Headed, Short Thd, Solid, Blunt Tip, Tia
P20-427-019F	Mini-Monster®, Screw, 2.7 x 19mm, Headed, Full Thd, Solid, Blunt Tip, Tia

Not all products available for sale in all markets. To determine availability in your marketplace, please contact your local Paragon 28 representative or email info@paragon28.com.

MINI-MONSTER® SCREWS AND INSTRUMENTATION

PART NUMBER	DESCRIPTION
P20-427-019S	Mini-Monster®, Screw, 2.7 x 19mm, Headed, Short Thd, Solid, Blunt Tip, Tia
P20-427-020F	Mini-Monster®, Screw, 2.7 x 20mm, Headed, Full Thd, Solid, Blunt Tip, Tia
P20-427-020S	Mini-Monster®, Screw, 2.7 x 20mm, Headed, Short Thd, Solid, Blunt Tip, Tia
P20-427-022F	Mini-Monster®, Screw, 2.7 x 22mm, Headed, Full Thd, Solid, Blunt Tip, Tia
P20-427-022S	Mini-Monster®, Screw, 2.7 x 22mm, Headed, Short Thd, Solid, Blunt Tip, Tia
P20-427-024F	Mini-Monster®, Screw, 2.7 x 24mm, Headed, Full Thd, Solid, Blunt Tip, Tia
P20-427-024S	Mini-Monster®, Screw, 2.7 x 24mm, Headed, Short Thd, Solid, Blunt Tip, Tia
P20-427-026F	Mini-Monster®, Screw, 2.7 x 26mm, Headed, Full Thd, Solid, Blunt Tip, Tia
P20-427-026S	Mini-Monster®, Screw, 2.7 x 26mm, Headed, Short Thd, Solid, Blunt Tip, Tia
P20-427-028F	Mini-Monster®, Screw, 2.7 x 28mm, Headed, Full Thd, Solid, Blunt Tip, Tia
P20-427-028S	Mini-Monster®, Screw, 2.7 x 28mm, Headed, Short Thd, Solid, Blunt Tip, Tia
P20-427-030F	Mini-Monster®, Screw, 2.7 x 30mm, Headed, Full Thd, Solid, Blunt Tip, Tia
P20-427-030S	Mini-Monster®, Screw, 2.7 x 30mm, Headed, Short Thd, Solid, Blunt Tip, Tia
P20-427-032F	Mini-Monster®, Screw, 2.7 x 32mm, Headed, Full Thd, Solid, Blunt Tip, Tia
P20-427-032S	Mini-Monster®, Screw, 2.7 x 32mm, Headed, Short Thd, Solid, Blunt Tip, Tia
P20-427-034F	Mini-Monster®, Screw, 2.7 x 34mm, Headed, Full Thd, Solid, Blunt Tip, Tia
P20-427-034S	Mini-Monster®, Screw, 2.7 x 34mm, Headed, Short Thd, Solid, Blunt Tip, Tia
P20-427-036F	Mini-Monster®, Screw, 2.7 x 36mm, Headed, Full Thd, Solid, Blunt Tip, Tia
P20-427-036S	Mini-Monster®, Screw, 2.7 x 36mm, Headed, Short Thd, Solid, Blunt Tip, Tia
P20-427-038F	Mini-Monster®, Screw, 2.7 x 38mm, Headed, Full Thd, Solid, Blunt Tip, Tia
P20-427-038S	Mini-Monster®, Screw, 2.7 x 38mm, Headed, Short Thd, Solid, Blunt Tip, Tia
P20-427-040F	Mini-Monster®, Screw, 2.7 x 40mm, Headed, Full Thd, Solid, Blunt Tip, Tia
P20-427-040S	Mini-Monster®, Screw, 2.7 x 40mm, Headed, Short Thd, Solid, Blunt Tip, Tia
P20-435-010F	Mini-Monster®, Screw, 3.5 x 10mm, Headed, Full Thd, Solid, Blunt Tip, Tia
P20-435-010S	Mini-Monster®, Screw, 3.5 x 10mm, Headed, Short Thd, Solid, Blunt Tip, Tia
P20-435-012F	Mini-Monster®, Screw, 3.5 x 12mm, Headed, Full Thd, Solid, Blunt Tip, Tia
P20-435-012S	Mini-Monster®, Screw, 3.5 x 12mm, Headed, Short Thd, Solid, Blunt Tip, Tia
P20-435-014F	Mini-Monster®, Screw, 3.5 x 14mm, Headed, Full Thd, Solid, Blunt Tip, Tia
P20-435-014S	Mini-Monster®, Screw, 3.5 x 14mm, Headed, Short Thd, Solid, Blunt Tip, Tia
P20-435-016F	Mini-Monster®, Screw, 3.5 x 16mm, Headed, Full Thd, Solid, Blunt Tip, Tia
P20-435-016S	Mini-Monster®, Screw, 3.5 x 16mm, Headed, Short Thd, Solid, Blunt Tip, Tia
P20-435-018F	Mini-Monster®, Screw, 3.5 x 18mm, Headed, Full Thd, Solid, Blunt Tip, Tia
P20-435-018S	Mini-Monster®, Screw, 3.5 x 18mm, Headed, Short Thd, Solid, Blunt Tip, Tia
P20-435-020F	Mini-Monster®, Screw, 3.5 x 20mm, Headed, Full Thd, Solid, Blunt Tip, Tia
P20-435-020S	Mini-Monster®, Screw, 3.5 x 20mm, Headed, Short Thd, Solid, Blunt Tip, Tia
P20-435-022F	Mini-Monster®, Screw, 3.5 x 22mm, Headed, Full Thd, Solid, Blunt Tip, Tia
P20-435-022S	Mini-Monster®, Screw, 3.5 x 22mm, Headed, Short Thd, Solid, Blunt Tip, Tia
P20-435-024F	Mini-Monster®, Screw, 3.5 x 24mm, Headed, Full Thd, Solid, Blunt Tip, Tia
P20-435-024S	Mini-Monster®, Screw, 3.5 x 24mm, Headed, Short Thd, Solid, Blunt Tip, Tia
P20-435-026F	Mini-Monster®, Screw, 3.5 x 26mm, Headed, Full Thd, Solid, Blunt Tip, Tia

Not all products available for sale in all markets. To determine availability in your marketplace, please contact your local Paragon 28 representative or email info@paragon28.com.

MINI-MONSTER® SCREWS AND INSTRUMENTATION

PART NUMBER	DESCRIPTION
P20-435-026S	Mini-Monster®, Screw, 3.5 x 26mm, Headed, Short Thd, Solid, Blunt Tip, Tia
P20-435-028F	Mini-Monster®, Screw, 3.5 x 28mm, Headed, Full Thd, Solid, Blunt Tip, Tia
P20-435-028S	Mini-Monster®, Screw, 3.5 x 28mm, Headed, Short Thd, Solid, Blunt Tip, Tia
P20-435-030F	Mini-Monster®, Screw, 3.5 x 30mm, Headed, Full Thd, Solid, Blunt Tip, Tia
P20-435-030S	Mini-Monster®, Screw, 3.5 x 30mm, Headed, Short Thd, Solid, Blunt Tip, Tia
P20-435-032F	Mini-Monster®, Screw, 3.5 x 32mm, Headed, Full Thd, Solid, Blunt Tip, Tia
P20-435-032S	Mini-Monster®, Screw, 3.5 x 32mm, Headed, Short Thd, Solid, Blunt Tip, Tia
P20-435-034F	Mini-Monster®, Screw, 3.5 x 34mm, Headed, Full Thd, Solid, Blunt Tip, Tia
P20-435-034S	Mini-Monster®, Screw, 3.5 x 34mm, Headed, Short Thd, Solid, Blunt Tip, Tia
P20-435-036F	Mini-Monster®, Screw, 3.5 x 36mm, Headed, Full Thd, Solid, Blunt Tip, Tia
P20-435-036S	Mini-Monster®, Screw, 3.5 x 36mm, Headed, Short Thd, Solid, Blunt Tip, Tia
P20-435-038F	Mini-Monster®, Screw, 3.5 x 38mm, Headed, Full Thd, Solid, Blunt Tip, Tia
P20-435-038S	Mini-Monster®, Screw, 3.5 x 38mm, Headed, Short Thd, Solid, Blunt Tip, Tia
P20-435-040F	Mini-Monster®, Screw, 3.5 x 40mm, Headed, Full Thd, Solid, Blunt Tip, Tia
P20-435-040S	Mini-Monster®, Screw, 3.5 x 40mm, Headed, Short Thd, Solid, Blunt Tip, Tia
P20-435-042F	Mini-Monster®, Screw, 3.5 x 42mm, Headed, Full Thd, Solid, Blunt Tip, Tia
P20-435-042S	Mini-Monster®, Screw, 3.5 x 42mm, Headed, Short Thd, Solid, Blunt Tip, Tia
P20-435-044F	Mini-Monster®, Screw, 3.5 x 44mm, Headed, Full Thd, Solid, Blunt Tip, Tia
P20-435-044S	Mini-Monster®, Screw, 3.5 x 44mm, Headed, Short Thd, Solid, Blunt Tip, Tia
P20-435-046F	Mini-Monster®, Screw, 3.5 x 46mm, Headed, Full Thd, Solid, Blunt Tip, Tia
P20-435-046S	Mini-Monster®, Screw, 3.5 x 46mm, Headed, Short Thd, Solid, Blunt Tip, Tia
P20-435-048F	Mini-Monster®, Screw, 3.5 x 48mm, Headed, Full Thd, Solid, Blunt Tip, Tia
P20-435-048S	Mini-Monster®, Screw, 3.5 x 48mm, Headed, Short Thd, Solid, Blunt Tip, Tia
P20-435-050F	Mini-Monster®, Screw, 3.5 x 50mm, Headed, Full Thd, Solid, Blunt Tip, Tia
P20-435-050S	Mini-Monster®, Screw, 3.5 x 50mm, Headed, Short Thd, Solid, Blunt Tip, Tia
P20-440-012F	Mini-Monster®, Screw, 4.0 x 12mm, Headed, Full Thd, Solid, Blunt Tip, Tia
P20-440-012S	Mini-Monster®, Screw, 4.0 x 12mm, Headed, Short Thd, Solid, Blunt Tip, Tia
P20-440-014F	Mini-Monster®, Screw, 4.0 x 14mm, Headed, Full Thd, Solid, Blunt Tip, Tia
P20-440-014S	Mini-Monster®, Screw, 4.0 x 14mm, Headed, Short Thd, Solid, Blunt Tip, Tia
P20-440-016F	Mini-Monster®, Screw, 4.0 x 16mm, Headed, Full Thd, Solid, Blunt Tip, Tia
P20-440-016S	Mini-Monster®, Screw, 4.0 x 16mm, Headed, Short Thd, Solid, Blunt Tip, Tia
P20-440-018F	Mini-Monster®, Screw, 4.0 x 18mm, Headed, Full Thd, Solid, Blunt Tip, Tia
P20-440-018S	Mini-Monster®, Screw, 4.0 x 18mm, Headed, Short Thd, Solid, Blunt Tip, Tia
P20-440-020F	Mini-Monster®, Screw, 4.0 x 20mm, Headed, Full Thd, Solid, Blunt Tip, Tia
P20-440-020S	Mini-Monster®, Screw, 4.0 x 20mm, Headed, Short Thd, Solid, Blunt Tip, Tia
P20-440-022F	Mini-Monster®, Screw, 4.0 x 22mm, Headed, Full Thd, Solid, Blunt Tip, Tia
P20-440-022S	Mini-Monster®, Screw, 4.0 x 22mm, Headed, Short Thd, Solid, Blunt Tip, Tia
P20-440-024F	Mini-Monster®, Screw, 4.0 x 24mm, Headed, Full Thd, Solid, Blunt Tip, Tia
P20-440-024S	Mini-Monster®, Screw, 4.0 x 24mm, Headed, Short Thd, Solid, Blunt Tip, Tia
P20-440-026F	Mini-Monster®, Screw, 4.0 x 26mm, Headed, Full Thd, Solid, Blunt Tip, Tia

Not all products available for sale in all markets. To determine availability in your marketplace, please contact your local Paragon 28 representative or email info@paragon28.com.

MINI-MONSTER® SCREWS AND INSTRUMENTATION

PART NUMBER	DESCRIPTION
P20-440-026S	Mini-Monster®, Screw, 4.0 x 26mm, Headed, Short Thd, Solid, Blunt Tip, Tia
P20-440-028F	Mini-Monster®, Screw, 4.0 x 28mm, Headed, Full Thd, Solid, Blunt Tip, Tia
P20-440-028S	Mini-Monster®, Screw, 4.0 x 28mm, Headed, Short Thd, Solid, Blunt Tip, Tia
P20-440-030F	Mini-Monster®, Screw, 4.0 x 30mm, Headed, Full Thd, Solid, Blunt Tip, Tia
P20-440-030S	Mini-Monster®, Screw, 4.0 x 30mm, Headed, Short Thd, Solid, Blunt Tip, Tia
P20-440-032F	Mini-Monster®, Screw, 4.0 x 32mm, Headed, Full Thd, Solid, Blunt Tip, Tia
P20-440-032S	Mini-Monster®, Screw, 4.0 x 32mm, Headed, Short Thd, Solid, Blunt Tip, Tia
P20-440-034F	Mini-Monster®, Screw, 4.0 x 34mm, Headed, Full Thd, Solid, Blunt Tip, Tia
P20-440-034S	Mini-Monster®, Screw, 4.0 x 34mm, Headed, Short Thd, Solid, Blunt Tip, Tia
P20-440-036F	Mini-Monster®, Screw, 4.0 x 36mm, Headed, Full Thd, Solid, Blunt Tip, Tia
P20-440-036S	Mini-Monster®, Screw, 4.0 x 36mm, Headed, Short Thd, Solid, Blunt Tip, Tia
P20-440-038F	Mini-Monster®, Screw, 4.0 x 38mm, Headed, Full Thd, Solid, Blunt Tip, Tia
P20-440-038S	Mini-Monster®, Screw, 4.0 x 38mm, Headed, Short Thd, Solid, Blunt Tip, Tia
P20-440-040F	Mini-Monster®, Screw, 4.0 x 40mm, Headed, Full Thd, Solid, Blunt Tip, Tia

Section 24:

MONSTER® HINDFOOT SCREW SYSTEM

Not all products available for sale in all markets. To determine availability in your marketplace, please contact your local Paragon 28 representative or email info@paragon28.com.



4.5 mm Headed and Headless Monster® Screws

4.5 MONSTER® HINDFOOT SCREWS

PART NUMBER	DESCRIPTION
P20-900-0021	4.5 Combination Headed/Headless Screw Caddy
P20-145-018S	Monster® Cannulated, Short Thread Screw, Headed, 4.5 X 18 mm
P20-145-020S	Monster® Cannulated, Short Thread Screw, Headed, 4.5 X 20 mm
P20-145-022S	Monster® Cannulated, Short Thread Screw, Headed, 4.5 X 22 mm
P20-145-024S	Monster® Cannulated, Short Thread Screw, Headed, 4.5 X 24 mm
P20-145-026S	Monster® Cannulated, Short Thread Screw, Headed, 4.5 X 26 mm
P20-145-028S	Monster® Cannulated, Short Thread Screw, Headed, 4.5 X 28 mm
P20-145-030S	Monster® Cannulated, Short Thread Screw, Headed, 4.5 X 30 mm
P20-145-032S	Monster® Cannulated, Short Thread Screw, Headed, 4.5 X 32 mm
P20-145-034S	Monster® Cannulated, Short Thread Screw, Headed, 4.5 X 34 mm
P20-145-036S	Monster® Cannulated, Short Thread Screw, Headed, 4.5 X 36 mm
P20-145-038S	Monster® Cannulated, Short Thread Screw, Headed, 4.5 X 38 mm
P20-145-040S	Monster® Cannulated, Short Thread Screw, Headed, 4.5 X 40 mm
P20-145-042S	Monster® Cannulated, Short Thread Screw, Headed, 4.5 X 42 mm
P20-145-044S	Monster® Cannulated, Short Thread Screw, Headed, 4.5 X 44 mm
P20-145-046S	Monster® Cannulated, Short Thread Screw, Headed, 4.5 X 46 mm
P20-145-048S	Monster® Cannulated, Short Thread Screw, Headed, 4.5 X 48 mm
P20-145-050S	Monster® Cannulated, Short Thread Screw, Headed, 4.5 X 50 mm
P20-145-055S	Monster® Cannulated, Short Thread Screw, Headed, 4.5 X 55 mm
P20-145-060S	Monster® Cannulated, Short Thread Screw, Headed, 4.5 X 60 mm
P20-145-065S	Monster® Cannulated, Short Thread Screw, Headed, 4.5 X 65 mm
P20-145-070S	Monster® Cannulated, Short Thread Screw, Headed, 4.5 X 70 mm
P20-545-018S	Monster® Cannulated, Short Thread Screw, Headless, 4.5 X 18 mm
P20-545-020S	Monster® Cannulated, Short Thread Screw, Headless, 4.5 X 20 mm
P20-545-022S	Monster® Cannulated, Short Thread Screw, Headless, 4.5 X 22 mm
P20-545-024S	Monster® Cannulated, Short Thread Screw, Headless, 4.5 X 24 mm
P20-545-026S	Monster® Cannulated, Short Thread Screw, Headless, 4.5 X 26 mm
P20-545-028S	Monster® Cannulated, Short Thread Screw, Headless, 4.5 X 28 mm
P20-545-030S	Monster® Cannulated, Short Thread Screw, Headless, 4.5 X 30 mm
P20-545-032S	Monster® Cannulated, Short Thread Screw, Headless, 4.5 X 32 mm

Not all products available for sale in all markets. To determine availability in your marketplace, please contact your local Paragon 28 representative or email info@paragon28.com.

4.5 MONSTER® HINDFOOT SCREWS

PART NUMBER	DESCRIPTION
P20-545-034S	Monster® Cannulated, Short Thread Screw, Headless, 4.5 X 34 mm
P20-545-036S	Monster® Cannulated, Short Thread Screw, Headless, 4.5 X 36 mm
P20-545-038S	Monster® Cannulated, Short Thread Screw, Headless, 4.5 X 38 mm
P20-545-040S	Monster® Cannulated, Short Thread Screw, Headless, 4.5 X 40 mm
P20-545-042S	Monster® Cannulated, Short Thread Screw, Headless, 4.5 X 42 mm
P20-545-044S	Monster® Cannulated, Short Thread Screw, Headless, 4.5 X 44 mm
P20-545-046S	Monster® Cannulated, Short Thread Screw, Headless, 4.5 X 46 mm
P20-545-048S	Monster® Cannulated, Short Thread Screw, Headless, 4.5 X 48 mm
P20-545-050S	Monster® Cannulated, Short Thread Screw, Headless, 4.5 X 50 mm
P20-545-055S	Monster® Cannulated, Short Thread Screw, Headless, 4.5 X 55 mm
P20-545-060S	Monster® Cannulated, Short Thread Screw, Headless, 4.5 X 60 mm
P20-545-065S	Monster® Cannulated, Short Thread Screw, Headless, 4.5 X 65 mm
P20-545-070S	Monster® Cannulated, Short Thread Screw, Headless, 4.5 X 70 mm
P20-145-020L	Monster® Cannulated, Long Thread Screw, Headed, 4.5 X 20 mm
P20-145-022L	Monster® Cannulated, Long Thread Screw, Headed, 4.5 X 22 mm
P20-145-024L	Monster® Cannulated, Long Thread Screw, Headed, 4.5 X 24 mm
P20-145-026L	Monster® Cannulated, Long Thread Screw, Headed, 4.5 X 26 mm
P20-145-028L	Monster® Cannulated, Long Thread Screw, Headed, 4.5 X 28 mm
P20-145-030L	Monster® Cannulated, Long Thread Screw, Headed, 4.5 X 30 mm
P20-145-032L	Monster® Cannulated, Long Thread Screw, Headed, 4.5 X 32 mm
P20-145-034L	Monster® Cannulated, Long Thread Screw, Headed, 4.5 X 34 mm
P20-145-036L	Monster® Cannulated, Long Thread Screw, Headed, 4.5 X 36 mm
P20-145-038L	Monster® Cannulated, Long Thread Screw, Headed, 4.5 X 38 mm
P20-145-040L	Monster® Cannulated, Long Thread Screw, Headed, 4.5 X 40 mm
P20-145-042L	Monster® Cannulated, Long Thread Screw, Headed, 4.5 X 42 mm
P20-145-044L	Monster® Cannulated, Long Thread Screw, Headed, 4.5 X 44 mm
P20-145-046L	Monster® Cannulated, Long Thread Screw, Headed, 4.5 X 46 mm
P20-145-048L	Monster® Cannulated, Long Thread Screw, Headed, 4.5 X 48 mm
P20-145-050L	Monster® Cannulated, Long Thread Screw, Headed, 4.5 X 50 mm
P20-145-055L	Monster® Cannulated, Long Thread Screw, Headed, 4.5 X 55 mm
P20-145-060L	Monster® Cannulated, Long Thread Screw, Headed, 4.5 X 60 mm
P20-145-065L	Monster® Cannulated, Long Thread Screw, Headed, 4.5 X 65 mm
P20-145-070L	Monster® Cannulated, Long Thread Screw, Headed, 4.5 X 70 mm
P20-545-030L	Monster® Cannulated, Long Thread Screw, Headless, 4.5 X 30 mm
P20-545-032L	Monster® Cannulated, Long Thread Screw, Headless, 4.5 X 32 mm
P20-545-034L	Monster® Cannulated, Long Thread Screw, Headless, 4.5 X 34 mm
P20-545-036L	Monster® Cannulated, Long Thread Screw, Headless, 4.5 X 36 mm
P20-545-038L	Monster® Cannulated, Long Thread Screw, Headless, 4.5 X 38 mm
P20-545-040L	Monster® Cannulated, Long Thread Screw, Headless, 4.5 X 40 mm
P20-545-042L	Monster® Cannulated, Long Thread Screw, Headless, 4.5 X 42 mm

Not all products available for sale in all markets. To determine availability in your marketplace, please contact your local Paragon 28 representative or email info@paragon28.com.

4.5 MONSTER® HINDFOOT SCREWS

PART NUMBER	DESCRIPTION
P20-545-044L	Monster® Cannulated, Long Thread Screw, Headless, 4.5 X 44 mm
P20-545-046L	Monster® Cannulated, Long Thread Screw, Headless, 4.5 X 46 mm
P20-545-048L	Monster® Cannulated, Long Thread Screw, Headless, 4.5 X 48 mm
P20-545-050L	Monster® Cannulated, Long Thread Screw, Headless, 4.5 X 50 mm
P20-545-055L	Monster® Cannulated, Long Thread Screw, Headless, 4.5 X 55 mm
P20-545-060L	Monster® Cannulated, Long Thread Screw, Headless, 4.5 X 60 mm
P20-545-065L	Monster® Cannulated, Long Thread Screw, Headless, 4.5 X 65 mm
P20-545-070L	Monster® Cannulated, Long Thread Screw, Headless, 4.5 X 70 mm
P20-145-018F	Monster® Cannulated, Full Thread Screw, Headed, 4.5 X 18 mm
P20-145-020F	Monster® Cannulated, Full Thread Screw, Headed, 4.5 X 20 mm
P20-145-022F	Monster® Cannulated, Full Thread Screw, Headed, 4.5 X 22 mm
P20-145-024F	Monster® Cannulated, Full Thread Screw, Headed, 4.5 X 24 mm
P20-145-026F	Monster® Cannulated, Full Thread Screw, Headed, 4.5 X 26 mm
P20-145-028F	Monster® Cannulated, Full Thread Screw, Headed, 4.5 X 28 mm
P20-145-030F	Monster® Cannulated, Full Thread Screw, Headed, 4.5 X 30 mm
P20-145-032F	Monster® Cannulated, Full Thread Screw, Headed, 4.5 X 32 mm
P20-145-034F	Monster® Cannulated, Full Thread Screw, Headed, 4.5 X 34 mm
P20-145-036F	Monster® Cannulated, Full Thread Screw, Headed, 4.5 X 36 mm
P20-145-038F	Monster® Cannulated, Full Thread Screw, Headed, 4.5 X 38 mm
P20-145-040F	Monster® Cannulated, Full Thread Screw, Headed, 4.5 X 40 mm
P20-145-042F	Monster® Cannulated, Full Thread Screw, Headed, 4.5 X 42 mm
P20-145-044F	Monster® Cannulated, Full Thread Screw, Headed, 4.5 X 44 mm
P20-145-046F	Monster® Cannulated, Full Thread Screw, Headed, 4.5 X 46 mm
P20-145-048F	Monster® Cannulated, Full Thread Screw, Headed, 4.5 X 48 mm
P20-145-050F	Monster® Cannulated, Full Thread Screw, Headed, 4.5 X 50 mm
P20-145-055F	Monster® Cannulated, Full Thread Screw, Headed, 4.5 X 55 mm
P20-145-060F	Monster® Cannulated, Full Thread Screw, Headed, 4.5 X 60 mm
P20-145-065F	Monster® Cannulated, Full Thread Screw, Headed, 4.5 X 65 mm
P20-145-070F	Monster® Cannulated, Full Thread Screw, Headed, 4.5 X 70 mm



Not all products available for sale in all markets. To determine availability in your marketplace, please contact your local Paragon 28 representative or email info@paragon28.com.

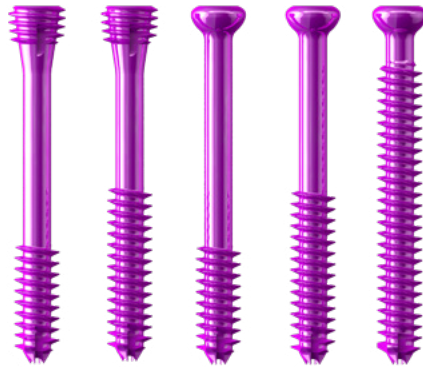

5.5 mm Headed and Headless Monster® Screws

5.5 MONSTER® HINDFOOT SCREWS

PART NUMBER	DESCRIPTION
P20-900-0022	Monster® 5.5mm Combination Headed and Headless Caddy
P20-155-026S	Monster® 5.5 x 26mm Headed Screw, Short Thread
P20-155-028S	Monster® 5.5 x 28mm Headed Screw, Short Thread
P20-155-030S	Monster® 5.5 x 30mm Headed Screw, Short Thread
P20-155-032S	Monster® 5.5 x 32mm Headed Screw, Short Thread
P20-155-034S	Monster® 5.5 x 34mm Headed Screw, Short Thread
P20-155-036S	Monster® 5.5 x 36mm Headed Screw, Short Thread
P20-155-038S	Monster® 5.5 x 38mm Headed Screw, Short Thread
P20-155-040S	Monster® 5.5 x 40mm Headed Screw, Short Thread
P20-155-042S	Monster® 5.5 x 42mm Headed Screw, Short Thread
P20-155-044S	Monster® 5.5 x 44mm Headed Screw, Short Thread
P20-155-046S	Monster® 5.5 x 46mm Headed Screw, Short Thread
P20-155-048S	Monster® 5.5 x 48mm Headed Screw, Short Thread
P20-155-050S	Monster® 5.5 x 50mm Headed Screw, Short Thread
P20-155-052S	Monster® 5.5 x 52mm Headed Screw, Short Thread
P20-155-054S	Monster® 5.5 x 54mm Headed Screw, Short Thread
P20-155-056S	Monster® 5.5 x 56mm Headed Screw, Short Thread
P20-155-058S	Monster® 5.5 x 58mm Headed Screw, Short Thread
P20-155-060S	Monster® 5.5 x 60mm Headed Screw, Short Thread
P20-155-065S	Monster® 5.5 x 65mm Headed Screw, Short Thread
P20-155-070S	Monster® 5.5 x 70mm Headed Screw, Short Thread
P20-155-075S	Monster® 5.5 x 75mm Headed Screw, Short Thread
P20-155-080S	Monster® 5.5 x 80mm Headed Screw, Short Thread
P20-155-085S	Monster® 5.5 x 85mm Headed Screw, Short Thread
P20-155-090S	Monster® 5.5 x 90mm Headed Screw, Short Thread
P20-555-026S	Monster® 5.5 x 26mm Headless Screw, Short Thread
P20-555-028S	Monster® 5.5 x 28mm Headless Screw, Short Thread
P20-555-030S	Monster® 5.5 x 30mm Headless Screw, Short Thread
P20-555-032S	Monster® 5.5 x 32mm Headless Screw, Short Thread
P20-555-034S	Monster® 5.5 x 34mm Headless Screw, Short Thread

Not all products available for sale in all markets. To determine availability in your marketplace, please contact your local Paragon 28 representative or email info@paragon28.com.

5.5 MONSTER® HINDFOOT SCREWS

PART NUMBER	DESCRIPTION
P20-555-036S	Monster® 5.5 x 36mm Headless Screw, Short Thread
P20-555-038S	Monster® 5.5 x 38mm Headless Screw, Short Thread
P20-555-040S	Monster® 5.5 x 40mm Headless Screw, Short Thread
P20-555-042S	Monster® 5.5 x 42mm Headless Screw, Short Thread
P20-555-044S	Monster® 5.5 x 44mm Headless Screw, Short Thread
P20-555-046S	Monster® 5.5 x 46mm Headless Screw, Short Thread
P20-555-048S	Monster® 5.5 x 48mm Headless Screw, Short Thread
P20-555-050S	Monster® 5.5 x 50mm Headless Screw, Short Thread
P20-555-052S	Monster® 5.5 x 52mm Headless Screw, Short Thread
P20-555-054S	Monster® 5.5 x 54mm Headless Screw, Short Thread
P20-555-056S	Monster® 5.5 x 56mm Headless Screw, Short Thread
P20-555-058S	Monster® 5.5 x 58mm Headless Screw, Short Thread
P20-555-060S	Monster® 5.5 x 60mm Headless Screw, Short Thread
P20-555-065S	Monster® 5.5 x 65mm Headless Screw, Short Thread
P20-555-070S	Monster® 5.5 x 70mm Headless Screw, Short Thread
P20-555-075S	Monster® 5.5 x 75mm Headless Screw, Short Thread
P20-555-080S	Monster® 5.5 x 80mm Headless Screw, Short Thread
P20-555-085S	Monster® 5.5 x 85mm Headless Screw, Short Thread
P20-555-090S	Monster® 5.5 x 90mm Headless Screw, Short Thread
P20-155-040L	Monster® 5.5 x 40mm Headed Screw, Long Thread
P20-155-042L	Monster® 5.5 x 42mm Headed Screw, Long Thread
P20-155-044L	Monster® 5.5 x 44mm Headed Screw, Long Thread
P20-155-046L	Monster® 5.5 x 46mm Headed Screw, Long Thread
P20-155-048L	Monster® 5.5 x 48mm Headed Screw, Long Thread
P20-155-050L	Monster® 5.5 x 50mm Headed Screw, Long Thread
P20-155-052L	Monster® 5.5 x 52mm Headed Screw, Long Thread
P20-155-054L	Monster® 5.5 x 54mm Headed Screw, Long Thread
P20-155-056L	Monster® 5.5 x 56mm Headed Screw, Long Thread
P20-155-058L	Monster® 5.5 x 58mm Headed Screw, Long Thread
P20-155-060L	Monster® 5.5 x 60mm Headed Screw, Long Thread
P20-155-065L	Monster® 5.5 x 65mm Headed Screw, Long Thread
P20-155-070L	Monster® 5.5 x 70mm Headed Screw, Long Thread
P20-155-075L	Monster® 5.5 x 75mm Headed Screw, Long Thread
P20-155-080L	Monster® 5.5 x 80mm Headed Screw, Long Thread
P20-155-085L	Monster® 5.5 x 85mm Headed Screw, Long Thread
P20-155-090L	Monster® 5.5 x 90mm Headed Screw, Long Thread
P20-555-040L	Monster® 5.5 x 40mm Headless Screw, Long Thread
P20-555-042L	Monster® 5.5 x 42mm Headless Screw, Long Thread
P20-555-044L	Monster® 5.5 x 44mm Headless Screw, Long Thread
P20-555-046L	Monster® 5.5 x 46mm Headless Screw, Long Thread

Not all products available for sale in all markets. To determine availability in your marketplace, please contact your local Paragon 28 representative or email info@paragon28.com.

5.5 MONSTER® HINDFOOT SCREWS

PART NUMBER	DESCRIPTION
P20-555-048L	Monster® 5.5 x 48mm Headless Screw, Long Thread
P20-555-050L	Monster® 5.5 x 50mm Headless Screw, Long Thread
P20-555-052L	Monster® 5.5 x 52mm Headless Screw, Long Thread
P20-555-054L	Monster® 5.5 x 54mm Headless Screw, Long Thread
P20-555-056L	Monster® 5.5 x 56mm Headless Screw, Long Thread
P20-555-058L	Monster® 5.5 x 58mm Headless Screw, Long Thread
P20-555-060L	Monster® 5.5 x 60mm Headless Screw, Long Thread
P20-555-065L	Monster® 5.5 x 65mm Headless Screw, Long Thread
P20-555-070L	Monster® 5.5 x 70mm Headless Screw, Long Thread
P20-555-075L	Monster® 5.5 x 75mm Headless Screw, Long Thread
P20-555-080L	Monster® 5.5 x 80mm Headless Screw, Long Thread
P20-555-085L	Monster® 5.5 x 85mm Headless Screw, Long Thread
P20-555-090L	Monster® 5.5 x 90mm Headless Screw, Long Thread
P20-155-026F	Monster® 5.5 x 26mm Headed Screw, Full Thread
P20-155-028F	Monster® 5.5 x 28mm Headed Screw, Full Thread
P20-155-030F	Monster® 5.5 x 30mm Headed Screw, Full Thread
P20-155-032F	Monster® 5.5 x 32mm Headed Screw, Full Thread
P20-155-034F	Monster® 5.5 x 34mm Headed Screw, Full Thread
P20-155-036F	Monster® 5.5 x 36mm Headed Screw, Full Thread
P20-155-038F	Monster® 5.5 x 38mm Headed Screw, Full Thread
P20-155-040F	Monster® 5.5 x 40mm Headed Screw, Full Thread
P20-155-042F	Monster® 5.5 x 42mm Headed Screw, Full Thread
P20-155-044F	Monster® 5.5 x 44mm Headed Screw, Full Thread
P20-155-046F	Monster® 5.5 x 46mm Headed Screw, Full Thread
P20-155-048F	Monster® 5.5 x 48mm Headed Screw, Full Thread
P20-155-050F	Monster® 5.5 x 50mm Headed Screw, Full Thread
P20-155-052F	Monster® 5.5 x 52mm Headed Screw, Full Thread
P20-155-054F	Monster® 5.5 x 54mm Headed Screw, Full Thread
P20-155-056F	Monster® 5.5 x 56mm Headed Screw, Full Thread
P20-155-058F	Monster® 5.5 x 58mm Headed Screw, Full Thread
P20-155-060F	Monster® 5.5 x 60mm Headed Screw, Full Thread
P20-155-065F	Monster® 5.5 x 65mm Headed Screw, Full Thread
P20-155-070F	Monster® 5.5 x 70mm Headed Screw, Full Thread
P20-155-075F	Monster® 5.5 x 75mm Headed Screw, Full Thread
P20-155-080F	Monster® 5.5 x 80mm Headed Screw, Full Thread
P20-155-085F	Monster® 5.5 x 85mm Headed Screw, Full Thread
P20-155-090F	Monster® 5.5 x 90mm Headed Screw, Full Thread



Not all products available for sale in all markets. To determine availability in your marketplace, please contact your local Paragon 28 representative or email info@paragon28.com.

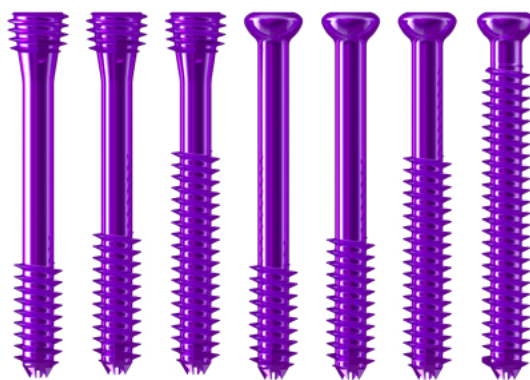

7.0 mm Headed and Headless Monster® Screws

7.0 MONSTER® HINDFOOT

PART NUMBER	DESCRIPTION
P20-900-0010	Caddy (7.0mm Combo Hd&Hdless)
P20-170-036S	Monster® Cannulated, Short Thread Screw, Headed, 7.0 x 36 mm
P20-170-038S	Monster® Cannulated, Short Thread Screw, Headed, 7.0 x 38 mm
P20-170-040S	Monster® Cannulated, Short Thread Screw, Headed, 7.0 x 40 mm
P20-170-042S	Monster® Cannulated, Short Thread Screw, Headed, 7.0 x 42 mm
P20-170-044S	Monster® Cannulated, Short Thread Screw, Headed, 7.0 x 44 mm
P20-170-046S	Monster® Cannulated, Short Thread Screw, Headed, 7.0 x 46 mm
P20-170-048S	Monster® Cannulated, Short Thread Screw, Headed, 7.0 x 48 mm
P20-170-050S	Monster® Cannulated, Short Thread Screw, Headed, 7.0 x 50 mm
P20-170-055S	Monster® Cannulated, Short Thread Screw, Headed, 7.0 x 55 mm
P20-170-060S	Monster® Cannulated, Short Thread Screw, Headed, 7.0 x 60 mm
P20-170-065S	Monster® Cannulated, Short Thread Screw, Headed, 7.0 x 65 mm
P20-170-070S	Monster® Cannulated, Short Thread Screw, Headed, 7.0 x 70 mm
P20-170-072S	Monster® Cannulated, Short Thread Screw, Headed, 7.0 x 72 mm
P20-170-074S	Monster® Cannulated, Short Thread Screw, Headed, 7.0 x 74 mm
P20-170-076S	Monster® Cannulated, Short Thread Screw, Headed, 7.0 x 76 mm
P20-170-078S	Monster® Cannulated, Short Thread Screw, Headed, 7.0 x 78 mm
P20-170-080S	Monster® Cannulated, Short Thread Screw, Headed, 7.0 x 80 mm
P20-170-082S	Monster® Cannulated, Short Thread Screw, Headed, 7.0 x 82 mm
P20-170-084S	Monster® Cannulated, Short Thread Screw, Headed, 7.0 x 84 mm
P20-170-086S	Monster® Cannulated, Short Thread Screw, Headed, 7.0 x 86 mm
P20-170-088S	Monster® Cannulated, Short Thread Screw, Headed, 7.0 x 88 mm
P20-170-090S	Monster® Cannulated, Short Thread Screw, Headed, 7.0 x 90 mm
P20-170-095S	Monster® Cannulated, Short Thread Screw, Headed, 7.0 x 95 mm
P20-170-100S	Monster® Cannulated, Short Thread Screw, Headed, 7.0 x 100 mm
P20-170-105S	Monster® Cannulated, Short Thread Screw, Headed, 7.0 x 105 mm
P20-170-110S	Monster® Cannulated, Short Thread Screw, Headed, 7.0 x 110 mm
P20-170-115S	Monster® Cannulated, Short Thread Screw, Headed, 7.0 x 115 mm
P20-170-120S	Monster® Cannulated, Short Thread Screw, Headed, 7.0 x 120 mm
P20-170-125S	Monster® Cannulated, Short Thread Screw, Headed, 7.0 x 125 mm

Not all products available for sale in all markets. To determine availability in your marketplace, please contact your local Paragon 28 representative or email info@paragon28.com.

7.0 MONSTER® HINDFOOT

PART NUMBER	DESCRIPTION
P20-170-130S	Monster® Cannulated, Short Thread Screw, Headed, 7.0 x 130 mm
P20-570-036S	Monster® Cannulated, Short Thread Screw, Headless, 7.0 x 36 mm
P20-570-038S	Monster® Cannulated, Short Thread Screw, Headless, 7.0 x 38 mm
P20-570-040S	Monster® Cannulated, Short Thread Screw, Headless, 7.0 x 40 mm
P20-570-042S	Monster® Cannulated, Short Thread Screw, Headless, 7.0 x 42 mm
P20-570-044S	Monster® Cannulated, Short Thread Screw, Headless, 7.0 x 44 mm
P20-570-046S	Monster® Cannulated, Short Thread Screw, Headless, 7.0 x 46 mm
P20-570-048S	Monster® Cannulated, Short Thread Screw, Headless, 7.0 x 48 mm
P20-570-050S	Monster® Cannulated, Short Thread Screw, Headless, 7.0 x 50 mm
P20-570-055S	Monster® Cannulated, Short Thread Screw, Headless, 7.0 x 55 mm
P20-570-060S	Monster® Cannulated, Short Thread Screw, Headless, 7.0 x 60 mm
P20-570-065S	Monster® Cannulated, Short Thread Screw, Headless, 7.0 x 65 mm
P20-570-070S	Monster® Cannulated, Short Thread Screw, Headless, 7.0 x 70 mm
P20-570-072S	Monster® Cannulated, Short Thread Screw, Headless, 7.0 x 72 mm
P20-570-074S	Monster® Cannulated, Short Thread Screw, Headless, 7.0 x 74 mm
P20-570-076S	Monster® Cannulated, Short Thread Screw, Headless, 7.0 x 76 mm
P20-570-078S	Monster® Cannulated, Short Thread Screw, Headless, 7.0 x 78 mm
P20-570-080S	Monster® Cannulated, Short Thread Screw, Headless, 7.0 x 80 mm
P20-570-082S	Monster® Cannulated, Short Thread Screw, Headless, 7.0 x 82 mm
P20-570-084S	Monster® Cannulated, Short Thread Screw, Headless, 7.0 x 84 mm
P20-570-086S	Monster® Cannulated, Short Thread Screw, Headless, 7.0 x 86 mm
P20-570-088S	Monster® Cannulated, Short Thread Screw, Headless, 7.0 x 88 mm
P20-570-090S	Monster® Cannulated, Short Thread Screw, Headless, 7.0 x 90 mm
P20-570-095S	Monster® Cannulated, Short Thread Screw, Headless, 7.0 x 95 mm
P20-570-100S	Monster® Cannulated, Short Thread Screw, Headless, 7.0 x 100 mm
P20-570-105S	Monster® Cannulated, Short Thread Screw, Headless, 7.0 x 105 mm
P20-570-110S	Monster® Cannulated, Short Thread Screw, Headless, 7.0 x 110 mm
P20-570-115S	Monster® Cannulated, Short Thread Screw, Headless, 7.0 x 115 mm
P20-570-120S	Monster® Cannulated, Short Thread Screw, Headless, 7.0 x 120 mm
P20-570-125S	Monster® Cannulated, Short Thread Screw, Headless, 7.0 x 125 mm
P20-570-130S	Monster® Cannulated, Short Thread Screw, Headless, 7.0 x 130 mm
P20-170-040M	Monster® Cannulated, Medium Thread Screw, Headed, 7.0 x 40 mm
P20-170-042M	Monster® Cannulated, Medium Thread Screw, Headed, 7.0 x 42 mm
P20-170-044M	Monster® Cannulated, Medium Thread Screw, Headed, 7.0 x 44 mm
P20-170-046M	Monster® Cannulated, Medium Thread Screw, Headed, 7.0 x 46 mm
P20-170-048M	Monster® Cannulated, Medium Thread Screw, Headed, 7.0 x 48 mm
P20-170-050M	Monster® Cannulated, Medium Thread Screw, Headed, 7.0 x 50 mm
P20-170-055M	Monster® Cannulated, Medium Thread Screw, Headed, 7.0 x 55 mm
P20-170-060M	Monster® Cannulated, Medium Thread Screw, Headed, 7.0 x 60 mm
P20-170-065M	Monster® Cannulated, Medium Thread Screw, Headed, 7.0 x 65 mm

Not all products available for sale in all markets. To determine availability in your marketplace, please contact your local Paragon 28 representative or email info@paragon28.com.

7.0 MONSTER® HINDFOOT

PART NUMBER	DESCRIPTION
P20-170-070M	Monster® Cannulated, Medium Thread Screw, Headed, 7.0 x 70 mm
P20-170-072M	Monster® Cannulated, Medium Thread Screw, Headed, 7.0 x 72 mm
P20-170-074M	Monster® Cannulated, Medium Thread Screw, Headed, 7.0 x 74 mm
P20-170-076M	Monster® Cannulated, Medium Thread Screw, Headed, 7.0 x 76 mm
P20-170-078M	Monster® Cannulated, Medium Thread Screw, Headed, 7.0 x 78 mm
P20-170-080M	Monster® Cannulated, Medium Thread Screw, Headed, 7.0 x 80 mm
P20-170-082M	Monster® Cannulated, Medium Thread Screw, Headed, 7.0 x 82 mm
P20-170-084M	Monster® Cannulated, Medium Thread Screw, Headed, 7.0 x 84 mm
P20-170-086M	Monster® Cannulated, Medium Thread Screw, Headed, 7.0 x 86 mm
P20-170-088M	Monster® Cannulated, Medium Thread Screw, Headed, 7.0 x 88 mm
P20-170-090M	Monster® Cannulated, Medium Thread Screw, Headed, 7.0 x 90 mm
P20-170-095M	Monster® Cannulated, Medium Thread Screw, Headed, 7.0 x 95 mm
P20-170-100M	Monster® Cannulated, Medium Thread Screw, Headed, 7.0 x 100 mm
P20-170-105M	Monster® Cannulated, Medium Thread Screw, Headed, 7.0 x 105 mm
P20-170-110M	Monster® Cannulated, Medium Thread Screw, Headed, 7.0 x 110 mm
P20-170-115M	Monster® Cannulated, Medium Thread Screw, Headed, 7.0 x 115 mm
P20-170-120M	Monster® Cannulated, Medium Thread Screw, Headed, 7.0 x 120 mm
P20-170-125M	Monster® Cannulated, Medium Thread Screw, Headed, 7.0 x 125 mm
P20-170-130M	Monster® Cannulated, Medium Thread Screw, Headed, 7.0 x 130 mm
P20-570-044M	Monster® Cannulated, Medium Thread Screw, Headless, 7.0 x 44 mm
P20-570-046M	Monster® Cannulated, Medium Thread Screw, Headless, 7.0 x 46 mm
P20-570-048M	Monster® Cannulated, Medium Thread Screw, Headless, 7.0 x 48 mm
P20-570-050M	Monster® Cannulated, Medium Thread Screw, Headless, 7.0 x 50 mm
P20-570-055M	Monster® Cannulated, Medium Thread Screw, Headless, 7.0 x 55 mm
P20-570-060M	Monster® Cannulated, Medium Thread Screw, Headless, 7.0 x 60 mm
P20-570-065M	Monster® Cannulated, Medium Thread Screw, Headless, 7.0 x 65 mm
P20-570-070M	Monster® Cannulated, Medium Thread Screw, Headless, 7.0 x 70 mm
P20-570-072M	Monster® Cannulated, Medium Thread Screw, Headless, 7.0 x 72 mm
P20-570-074M	Monster® Cannulated, Medium Thread Screw, Headless, 7.0 x 74 mm
P20-570-076M	Monster® Cannulated, Medium Thread Screw, Headless, 7.0 x 76 mm
P20-570-078M	Monster® Cannulated, Medium Thread Screw, Headless, 7.0 x 78 mm
P20-570-080M	Monster® Cannulated, Medium Thread Screw, Headless, 7.0 x 80 mm
P20-570-082M	Monster® Cannulated, Medium Thread Screw, Headless, 7.0 x 82 mm
P20-570-084M	Monster® Cannulated, Medium Thread Screw, Headless, 7.0 x 84 mm
P20-570-086M	Monster® Cannulated, Medium Thread Screw, Headless, 7.0 x 86 mm
P20-570-088M	Monster® Cannulated, Medium Thread Screw, Headless, 7.0 x 88 mm
P20-570-090M	Monster® Cannulated, Medium Thread Screw, Headless, 7.0 x 90 mm
P20-570-095M	Monster® Cannulated, Medium Thread Screw, Headless, 7.0 x 95 mm
P20-570-100M	Monster® Cannulated, Medium Thread Screw, Headless, 7.0 x 100 mm
P20-570-105M	Monster® Cannulated, Medium Thread Screw, Headless, 7.0 x 105 mm

Not all products available for sale in all markets. To determine availability in your marketplace, please contact your local Paragon 28 representative or email info@paragon28.com.

7.0 MONSTER® HINDFOOT

PART NUMBER	DESCRIPTION
P20-570-110M	Monster® Cannulated, Medium Thread Screw, Headless, 7.0 x 110 mm
P20-570-115M	Monster® Cannulated, Medium Thread Screw, Headless, 7.0 x 115 mm
P20-570-120M	Monster® Cannulated, Medium Thread Screw, Headless, 7.0 x 120 mm
P20-570-125M	Monster® Cannulated, Medium Thread Screw, Headless, 7.0 x 125 mm
P20-570-130M	Monster® Cannulated, Medium Thread Screw, Headless, 7.0 x 130 mm
P20-170-044L	Monster® Cannulated, Long Thread Screw, Headed, 7.0 x 44 mm
P20-170-046L	Monster® Cannulated, Long Thread Screw, Headed, 7.0 x 46 mm
P20-170-048L	Monster® Cannulated, Long Thread Screw, Headed, 7.0 x 48 mm
P20-170-050L	Monster® Cannulated, Long Thread Screw, Headed, 7.0 x 50 mm
P20-170-055L	Monster® Cannulated, Long Thread Screw, Headed, 7.0 x 55 mm
P20-170-060L	Monster® Cannulated, Long Thread Screw, Headed, 7.0 x 60 mm
P20-170-065L	Monster® Cannulated, Long Thread Screw, Headed, 7.0 x 65 mm
P20-170-070L	Monster® Cannulated, Long Thread Screw, Headed, 7.0 x 70 mm
P20-170-072L	Monster® Cannulated, Long Thread Screw, Headed, 7.0 x 72 mm
P20-170-074L	Monster® Cannulated, Long Thread Screw, Headed, 7.0 x 74 mm
P20-170-076L	Monster® Cannulated, Long Thread Screw, Headed, 7.0 x 76 mm
P20-170-078L	Monster® Cannulated, Long Thread Screw, Headed, 7.0 x 78 mm
P20-170-080L	Monster® Cannulated, Long Thread Screw, Headed, 7.0 x 80 mm
P20-170-082L	Monster® Cannulated, Long Thread Screw, Headed, 7.0 x 82 mm
P20-170-084L	Monster® Cannulated, Long Thread Screw, Headed, 7.0 x 84 mm
P20-170-086L	Monster® Cannulated, Long Thread Screw, Headed, 7.0 x 86 mm
P20-170-088L	Monster® Cannulated, Long Thread Screw, Headed, 7.0 x 88 mm
P20-170-090L	Monster® Cannulated, Long Thread Screw, Headed, 7.0 x 90 mm
P20-170-095L	Monster® Cannulated, Long Thread Screw, Headed, 7.0 x 95 mm
P20-170-100L	Monster® Cannulated, Long Thread Screw, Headed, 7.0 x 100 mm
P20-170-105L	Monster® Cannulated, Long Thread Screw, Headed, 7.0 x 105 mm
P20-170-110L	Monster® Cannulated, Long Thread Screw, Headed, 7.0 x 110 mm
P20-170-115L	Monster® Cannulated, Long Thread Screw, Headed, 7.0 x 115 mm
P20-170-120L	Monster® Cannulated, Long Thread Screw, Headed, 7.0 x 120 mm
P20-170-125L	Monster® Cannulated, Long Thread Screw, Headed, 7.0 x 125 mm
P20-170-130L	Monster® Cannulated, Long Thread Screw, Headed, 7.0 x 130 mm
P20-570-060L	Monster® Cannulated, Long Thread Screw, Headless, 7.0 x 60 mm
P20-570-065L	Monster® Cannulated, Long Thread Screw, Headless, 7.0 x 65 mm
P20-570-070L	Monster® Cannulated, Long Thread Screw, Headless, 7.0 x 70 mm
P20-570-072L	Monster® Cannulated, Long Thread Screw, Headless, 7.0 x 72 mm
P20-570-074L	Monster® Cannulated, Long Thread Screw, Headless, 7.0 x 74 mm
P20-570-076L	Monster® Cannulated, Long Thread Screw, Headless, 7.0 x 76 mm
P20-570-078L	Monster® Cannulated, Long Thread Screw, Headless, 7.0 x 78 mm
P20-570-080L	Monster® Cannulated, Long Thread Screw, Headless, 7.0 x 80 mm
P20-570-082L	Monster® Cannulated, Long Thread Screw, Headless, 7.0 x 82 mm

Not all products available for sale in all markets. To determine availability in your marketplace, please contact your local Paragon 28 representative or email info@paragon28.com.

7.0 MONSTER® HINDFOOT

PART NUMBER	DESCRIPTION
P20-570-084L	Monster® Cannulated, Long Thread Screw, Headless, 7.0 x 84 mm
P20-570-086L	Monster® Cannulated, Long Thread Screw, Headless, 7.0 x 86 mm
P20-570-088L	Monster® Cannulated, Long Thread Screw, Headless, 7.0 x 88 mm
P20-570-090L	Monster® Cannulated, Long Thread Screw, Headless, 7.0 x 90 mm
P20-570-095L	Monster® Cannulated, Long Thread Screw, Headless, 7.0 x 95 mm
P20-570-100L	Monster® Cannulated, Long Thread Screw, Headless, 7.0 x 100 mm
P20-570-105L	Monster® Cannulated, Long Thread Screw, Headless, 7.0 x 105 mm
P20-570-110L	Monster® Cannulated, Long Thread Screw, Headless, 7.0 x 110 mm
P20-570-115L	Monster® Cannulated, Long Thread Screw, Headless, 7.0 x 115 mm
P20-570-120L	Monster® Cannulated, Long Thread Screw, Headless, 7.0 x 120 mm
P20-570-125L	Monster® Cannulated, Long Thread Screw, Headless, 7.0 x 125 mm
P20-570-130L	Monster® Cannulated, Long Thread Screw, Headless, 7.0 x 130 mm
P20-170-036F	Monster® Cannulated, Full Thread Screw, Headed, 7.0 x 36 mm
P20-170-038F	Monster® Cannulated, Full Thread Screw, Headed, 7.0 x 38 mm
P20-170-040F	Monster® Cannulated, Full Thread Screw, Headed, 7.0 x 40 mm
P20-170-042F	Monster® Cannulated, Full Thread Screw, Headed, 7.0 x 42 mm
P20-170-044F	Monster® Cannulated, Full Thread Screw, Headed, 7.0 x 44 mm
P20-170-046F	Monster® Cannulated, Full Thread Screw, Headed, 7.0 x 46 mm
P20-170-048F	Monster® Cannulated, Full Thread Screw, Headed, 7.0 x 48 mm
P20-170-050F	Monster® Cannulated, Full Thread Screw, Headed, 7.0 x 50 mm
P20-170-055F	Monster® Cannulated, Full Thread Screw, Headed, 7.0 x 55 mm
P20-170-060F	Monster® Cannulated, Full Thread Screw, Headed, 7.0 x 60 mm
P20-170-065F	Monster® Cannulated, Full Thread Screw, Headed, 7.0 x 65 mm
P20-170-070F	Monster® Cannulated, Full Thread Screw, Headed, 7.0 x 70 mm
P20-170-072F	Monster® Cannulated, Full Thread Screw, Headed, 7.0 x 72 mm
P20-170-074F	Monster® Cannulated, Full Thread Screw, Headed, 7.0 x 74 mm
P20-170-076F	Monster® Cannulated, Full Thread Screw, Headed, 7.0 x 76 mm
P20-170-078F	Monster® Cannulated, Full Thread Screw, Headed, 7.0 x 78 mm
P20-170-080F	Monster® Cannulated, Full Thread Screw, Headed, 7.0 x 80 mm
P20-170-082F	Monster® Cannulated, Full Thread Screw, Headed, 7.0 x 82 mm
P20-170-084F	Monster® Cannulated, Full Thread Screw, Headed, 7.0 x 84 mm
P20-170-086F	Monster® Cannulated, Full Thread Screw, Headed, 7.0 x 86 mm
P20-170-088F	Monster® Cannulated, Full Thread Screw, Headed, 7.0 x 88 mm
P20-170-090F	Monster® Cannulated, Full Thread Screw, Headed, 7.0 x 90 mm
P20-170-095F	Monster® Cannulated, Full Thread Screw, Headed, 7.0 x 95 mm
P20-170-100F	Monster® Cannulated, Full Thread Screw, Headed, 7.0 x 100 mm
P20-170-105F	Monster® Cannulated, Full Thread Screw, Headed, 7.0 x 105 mm
P20-170-110F	Monster® Cannulated, Full Thread Screw, Headed, 7.0 x 110 mm
P20-170-115F	Monster® Cannulated, Full Thread Screw, Headed, 7.0 x 115 mm
P20-170-120F	Monster® Cannulated, Full Thread Screw, Headed, 7.0 x 120 mm

Not all products available for sale in all markets. To determine availability in your marketplace, please contact your local Paragon 28 representative or email info@paragon28.com.

7.0 MONSTER® HINDFOOT

PART NUMBER	DESCRIPTION
P20-170-125F	Monster® Cannulated, Full Thread Screw, Headed, 7.0 x 125 mm
P20-170-130F	Monster® Cannulated, Full Thread Screw, Headed, 7.0 x 130 mm

Not all products available for sale in all markets. To determine availability in your marketplace, please contact your local Paragon 28 representative or email info@paragon28.com.

MONSTER® HINDFOOT INSTRUMENTATION, CASE, AND TRAY

PART NUMBER	DESCRIPTION
P20-900-0001	Case Lid
P20-900-0002	Case Bottom Assy
P20-900-0003	Instrument Tray
P99-900-1005	Footplate
P20-900-0008	K-Wire Caddy Assy Short
P20-900-0009	K-Wire Caddy Assy Long
P20-045-WD00	Dome Washer for Monster Screw 4.5mm
P20-045-WF00	Flat Washer for Monster Screw 4.5mm
P20-055-WD00	Dome Washer for Monster Screw 5.5mm
P20-055-WF00	Flat Washer for Monster Screw 5.5mm
P20-070-WD00	Dome Washer for Monster Screw 7.0mm
P20-070-WF00	Flat Washer for Monster Screw 7.0mm
P20-070-WFS0	Monster, Washer, 7.0mm Slotted
P20-070-WB00	Monster Screw Bowl Washer, 7.0 mm
P99-110-7020	Overdrill, cannulated, 7.0 x 200mm
P99-192-1415	1.4 x 150 mm, K-wire, Single Ended Trocar Tip, Smooth
P99-192-1615	1.6 x 150 mm, K-wire, Single Ended Trocar Tip, Smooth
P99-192-2323	2.3 x 230 mm, K-wire, Single Ended Trocar Tip, Smooth
P99-193-1415	1.4 x 150 mm, K-wire, Threaded
P20-910-4500	4.5 mm Monster Screw Headed Countersink
P20-910-5500	5.5 mm Monster Screw Headed Countersink
P20-910-7000	7.0 mm Monster Screw Headed Countersink
P20-915-4500	4.5 mm Monster Screw Headless Countersink
P20-915-5500	5.5 mm Monster Screw Headless Countersink
P20-915-7000	7.0mm Monster Screw Headless Countersink
P20-920-4500	4.5 mm Monster Screw Tap
P20-920-5500	5.5 mm Monster Screw Tap
P20-920-7000	7.0 mm Monster Screw Tap
P20-930-7000	7.0 mm Tissue Protector
P20-931-7000	7.0 mm Drill Guide
P20-932-4500	1.4 mm K-wire Guide
P20-932-5500	1.6 mm K-wire Guide
P20-932-7000	2.3 mm K-wire Guide
P20-935-7000	7.0 mm Parallel K-wire Drill Guide
P20-940-4555	4.5/5.5 Double-Ended Drill Guide
P20-952-4555	4.5 & 5.5 Monster Depth Gauge
P20-952-7000	Monster 7.0 Depth Gauge
P99-000-316A	3/16 Sq to Jacobs Adapter
P99-000-316L	Axial Ratcheting Handle, Large, 3/16 Sq ADPT
P99-000-316M	Axial Ratcheting Handle, Medium, 3/16 Sq ADPT

Not all products available for sale in all markets. To determine availability in your marketplace, please contact your local Paragon 28 representative or email info@paragon28.com.

MONSTER® HINDFOOT INSTRUMENTATION, CASE, AND TRAY

PART NUMBER	DESCRIPTION
P99-110-2914	Drill, 2.9 x 140 mm Long, Cannulated, 3/16 Sq. (4.5 HF)
P99-110-3516	Drill, 3.5 x 160 mm Long, Cannulated, 3/16 Sq (5.5 HF)
P99-110-4511	Overdrill, Cannulated, 4.5 x 110mm
P99-110-4622	Drill, 4.6 x 220 mm Long, Cannulated, 3/16 Sq (7.0 HF)
P99-110-5513	Overdrill, Cannulated, 3/16 sq connection, 5.5 x 130mm
P99-150-0001	Screw Forceps
P99-150-0010	Hintermann Hindfoot Distractor, 2.5 & 3.0 K-wire
P99-190-TX15	TX-15 Monster Screw Cannulated Driver
P99-190-TX25	TX-25 Monster Screw Cannulated Driver
P99-190-TX30	TX-30 Monster Screw Cannulated Driver
P99-190-TX30-17	TX-30, 170mm Long Monster Screw Cannulated Driver
P99-193-1615	1.6 x 150 mm K-wire, Threaded
P99-193-2323	2.3 x 230 mm K-wire, Single Ended Trocar Tip, Threaded
P99-194-2323	2.3 x 230 mm, K-wire, Single Trocar Tip, Smooth, w/ FlouroBand
P99-195-2323	2.3 x 230 mm, K-wire, Single Trocar Tip, Threaded, w/ FlouroBand
P99-998-0014	1.4 mm Monster Screw Cannulated Cleaning Stylet
P99-998-0023	7.0mm Monster Screw 2.3mm Cleaning Stylet
P20-910-WB70	Monster, Countersink, 7.0mm, Bowl Washer

Not all products available for sale in all markets. To determine availability in your marketplace, please contact your local Paragon 28 representative or email info@paragon28.com.

4.5 & 5.5 MONSTER® HINDFOOT INSTRUMENTATION

PART NUMBER	DESCRIPTION
P50-900-5001	P28 Caddy Lid, Half DIN Caddies
P50-900-5002	P28 Caddy Base, Half DIN Caddies
P99-900-1007	Footplate
P20-900-7004	Caddy, Insert, Monster Instrument, Upper Tray
P99-110-2914	Drill, 2.9 x 140 mm Long, Cannulated, 3/16 Sq. (4.5 HF)
P99-110-3516	Drill, 3.5 x 160 mm Long, Cannulated, 3/16 Sq (5.5 HF)
P99-998-0014	1.4 mm Monster Screw Cannulated Cleaning Stylet
P99-998-0023	7.0mm Monster Screw 2.3mm Cleaning Stylet
P99-192-1415	1.4 x 150 mm, K-wire, Single Ended Trocar Tip, SMOOTH
P99-192-1615	1.6 x 150 mm, K-wire, Single Ended Trocar Tip, SMOOTH
P99-193-1415	1.4 x 150 mm, K-wire, THREADED
P99-193-1615	1.6 x 150 mm, K-wire, THREADED
P20-910-4500	4.5 mm Monster Screw HEADED Countersink
P20-910-5500	5.5 mm Monster Screw HEADED Countersink
P20-915-4500	4.5 mm Monster Screw HEADLESS Countersink
P20-915-5500	5.5 mm Monster Screw HEADLESS Countersink
P20-920-4500	4.5 mm Monster Screw Tap
P20-920-5500	5.5 mm Monster Screw Tap
P20-900-7003	Caddy, Insert, Monster Instrument, Middle Tray
P20-932-4500	1.4 mm K-wire Guide
P20-932-5500	1.6 mm K-wire Guide
P20-940-4555	4.5/5.5 Double-Ended Drill Guide
P20-952-4555	4.5 & 5.5 MONSTER DEPTH GAUGE
P99-110-4511	Overdrill, cannulated, 4.5 x 110mm
P99-110-5513	Overdrill, cannulated, 3/16 sq connection, 5.5 x 130mm
P99-150-0001	Screw Forceps
P20-900-7002	Caddy, Insert, Monster Instrument, Lower Tray
P99-150-0010	Hintermann Hindfoot Distractor, 2.5 & 3.0 K-wire
P99-190-TX15	TX-15 Monster Screw Cannulated Driver
P99-190-TX25	TX-25 Monster Screw Cannulated Driver
P99-000-316A	3/16 Sq to Jacobs Adapter
P99-000-316L	Axial Ratcheting Handle, LARGE, 3/16 Sq ADPT
P99-000-316M	Axial Ratcheting Handle, MEDIUM, 3/16 Sq ADPT
P20-045-WD00	Dome Washer for Monster Screw 4.5mm
P20-045-WF00	Flat Washer for Monster Screw 4.5mm
P20-055-WD00	Dome Washer for Monster Screw 5.5mm
P20-055-WF00	Flat Washer for Monster Screw 5.5mm
MS55CI-XXX	Monster Hindfoot 5.5 Ø Combination, Stainless Screw Caddy, OUS
MS45CI-XXX	Monster Hindfoot 4.5 Ø Combination, Stainless Screw Caddy, OUS

Not all products available for sale in all markets. To determine availability in your marketplace, please contact your local Paragon 28 representative or email info@paragon28.com.

4.5 & 7.0 MONSTER® HINDFOOT INSTRUMENTATION

PART NUMBER	DESCRIPTION
P50-900-5001	P28 Caddy Lid, Half DIN Caddies
P50-900-5002	P28 Caddy Base, Half DIN Caddies
P99-900-1007	Footplate
P20-900-7004	Caddy, Insert, Monster Instrument, Upper Tray
P99-110-2914	Drill, 2.9 x 140 mm Long, Cannulated, 3/16 Sq. (4.5 HF)
P99-110-4622	Drill, 4.6 x 220 mm Long, Cannulated, 3/16 Sq (7.0 HF)
P99-998-0014	1.4 mm Monster Screw Cannulated Cleaning Stylet
P99-998-0023	7.0mm Monster Screw 2.3mm Cleaning Stylet
P99-192-1415	1.4 x 150 mm, K-wire, Single Ended Trocar Tip, SMOOTH
P99-193-1415	1.4 x 150 mm, K-wire, THREADED
P99-192-2323	2.3 x 230 mm, K-wire, Single Ended Trocar Tip, SMOOTH
P99-193-2323	2.3 x 230 mm, K-wire, Single Ended Trocar Tip, THREADED
P99-194-2323	2.3 x 230 mm, K-wire, Single Trocar Tip, SMOOTH, w/ FlouroBand
P99-195-2323	2.3 x 230 mm, K-wire, Single Trocar Tip, THREADED, w/ FlouroBand
P20-910-4500	4.5 mm Monster Screw HEADED Countersink
P20-910-7000	7.0 mm Monster Screw HEADED Countersink
P20-915-4500	4.5 mm Monster Screw HEADLESS Countersink
P20-915-7000	7.0mm Monster Screw HEADLESS Countersink
P20-920-4500	4.5 mm Monster Screw Tap
P20-920-7000	7.0 mm Monster Screw Tap
P20-900-7003	Caddy, Insert, Monster Instrument, Middle Tray
P99-110-7020	Overdrill, cannulated, 7.0 x 200mm
P20-930-7000	7.0 mm Tissue Protector
P20-931-7000	7.0 mm Drill Guide
P20-932-4500	1.4 mm K-wire Guide
P20-932-7000	2.3 mm K-wire Guide
P20-935-7000	7.0 mm Parallel K-wire Drill Guide
P20-940-4555	4.5/5.5 Double-Ended Drill Guide
P20-952-4555	4.5 & 5.5 MONSTER DEPTH GAUGE
P20-952-7000	Monster 7.0 Depth Gauge
P99-110-4511	Overdrill, cannulated, 4.5 x 110mm
P99-150-0001	Screw Forceps
P20-910-WB70	Monster, Countersink, 7.0mm, Bowl Washer
P20-900-7002	Caddy, Insert, Monster Instrument, Lower Tray
P99-150-0010	Hintermann Hindfoot Distractor, 2.5 & 3.0 K-wire
P99-190-TX15	TX-15 Monster Screw Cannulated Driver
P99-190-TX30	TX-30 Monster Screw Cannulated Driver
P99-190-TX30-17	TX-30, 170mm Long Monster Screw Cannulated Driver
P99-000-316A	3/16 Sq to Jacobs Adapter
P99-000-316L	Axial Ratcheting Handle, LARGE, 3/16 Sq ADPT

Not all products available for sale in all markets. To determine availability in your marketplace, please contact your local Paragon 28 representative or email info@paragon28.com.

4.5 & 7.0 MONSTER® HINDFOOT INSTRUMENTATION

PART NUMBER	DESCRIPTION
P99-000-316M	Axial Ratcheting Handle, MEDIUM, 3/16 Sq ADPT
P20-045-WD00	Dome Washer for Monster Screw 4.5mm
P20-045-WF00	Flat Washer for Monster Screw 4.5mm
P20-070-WD00	Dome Washer for Monster Screw 7.0mm
P20-070-WF00	Flat Washer for Monster Screw 7.0mm
P20-070-WFS0	Monster, Washer, 7.0mm Slotted
P20-070-WB00	Monster Screw Bowl Washer, 7.0 mm
MS70CI-XXX	Monster Hindfoot 7.0 Ø Combination, Stainless Screw Caddy, OUS
MS45CI-XXX	Monster Hindfoot 4.5 Ø Combination, Stainless Screw Caddy, OUS

Not all products available for sale in all markets. To determine availability in your marketplace, please contact your local Paragon 28 representative or email info@paragon28.com.

5.5 & 7.0 MONSTER® HINDFOOT INSTRUMENTATION

PART NUMBER	DESCRIPTION
P50-900-5001	P28 Caddy Lid, Half DIN Caddies
P50-900-5002	P28 Caddy Base, Half DIN Caddies
P99-900-1007	Footplate
P20-900-7004	Caddy, Insert, Monster Instrument, Upper Tray
P99-110-3516	Drill, 3.5 x 160 mm Long, Cannulated, 3/16 Sq (5.5 HF)
P99-110-4622	Drill, 4.6 x 220 mm Long, Cannulated, 3/16 Sq (7.0 HF)
P99-998-0014	1.4 mm Monster Screw Cannulated Cleaning Stylet
P99-998-0023	7.0mm Monster Screw 2.3mm Cleaning Stylet
P99-192-1615	1.6 x 150 mm, K-wire, Single Ended Trocar Tip, SMOOTH
P99-193-1615	1.6 x 150 mm, K-wire, THREADED
P99-192-2323	2.3 x 230 mm, K-wire, Single Ended Trocar Tip, SMOOTH
P99-193-2323	2.3 x 230 mm, K-wire, Single Ended Trocar Tip, THREADED
P99-194-2323	2.3 x 230 mm, K-wire, Single Trocar Tip, SMOOTH, w/ FlouroBand
P99-195-2323	2.3 x 230 mm, K-wire, Single Trocar Tip, THREADED, w/ FlouroBand
P20-910-5500	5.5 mm Monster Screw HEADED Countersink
P20-910-7000	7.0 mm Monster Screw HEADED Countersink
P20-915-5500	5.5 mm Monster Screw HEADLESS Countersink
P20-915-7000	7.0mm Monster Screw HEADLESS Countersink
P20-920-5500	5.5 mm Monster Screw Tap
P20-920-7000	7.0 mm Monster Screw Tap
P20-900-7003	Caddy, Insert, Monster Instrument, Middle Tray
P99-110-7020	Overdrill, cannulated, 7.0 x 200mm
P20-930-7000	7.0 mm Tissue Protector
P20-931-7000	7.0 mm Drill Guide
P20-932-5500	1.6 mm K-wire Guide
P20-932-7000	2.3 mm K-wire Guide
P20-935-7000	7.0 mm Parallel K-wire Drill Guide
P20-940-4555	4.5/5.5 Double-Ended Drill Guide
P20-952-4555	4.5 & 5.5 MONSTER DEPTH GAUGE
P20-952-7000	Monster 7.0 Depth Gauge
P99-110-5513	Overdrill, cannulated, 3/16 sq connection, 5.5 x 130mm
P99-150-0001	Screw Forceps
P20-910-WB70	Monster, Countersink, 7.0mm, Bowl Washer
P20-900-7002	Caddy, Insert, Monster Instrument, Lower Tray
P99-150-0010	Hintermann Hindfoot Distractor, 2.5 & 3.0 K-wire
P99-190-TX25	TX-25 Monster Screw Cannulated Driver
P99-190-TX30	TX-30 Monster Screw Cannulated Driver
P99-190-TX30-17	TX-30, 170mm Long Monster Screw Cannulated Driver
P99-000-316A	3/16 Sq to Jacobs Adapter
P99-000-316L	Axial Ratcheting Handle, LARGE, 3/16 Sq ADPT

Not all products available for sale in all markets. To determine availability in your marketplace, please contact your local Paragon 28 representative or email info@paragon28.com.

5.5 & 7.0 MONSTER® HINDFOOT INSTRUMENTATION

PART NUMBER	DESCRIPTION
P99-000-316M	Axial Ratcheting Handle, MEDIUM, 3/16 Sq ADPT
P20-055-WD00	Dome Washer for Monster Screw 5.5mm
P20-055-WF00	Flat Washer for Monster Screw 5.5mm
P20-070-WD00	Dome Washer for Monster Screw 7.0mm
P20-070-WF00	Flat Washer for Monster Screw 7.0mm
P20-070-WFS0	Monster, Washer, 7.0mm Slotted
P20-070-WB00	Monster Screw Bowl Washer, 7.0 mm
MS70CI-XXX	Monster Hindfoot 7.0 Ø Combination, Stainless Screw Caddy, OUS
MS55CI-XXX	Monster Hindfoot 5.5 Ø Combination, Stainless Screw Caddy, OUS

Not all products available for sale in all markets. To determine availability in your marketplace, please contact your local Paragon 28 representative or email info@paragon28.com.

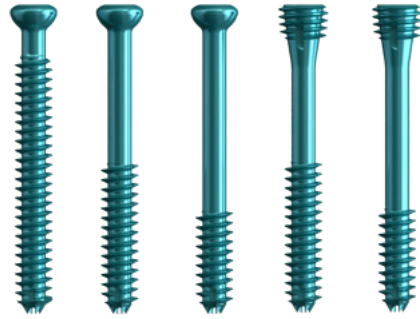

4.5 mm Headed and Headless Monster® Screws

4.5 MONSTER® HINDFOOT SCREWS (STAINLESS STEEL CADDY)

PART NUMBER	DESCRIPTION
P20-901-2021	Monster 4.5mm Combination Screw Caddy, Stainless Steel
P20-145-018S	Monster 4.5 X 18mm Headed Screw, Short Thread
P20-145-020S	Monster 4.5 X 20mm Headed Screw, Short Thread
P20-145-022S	Monster 4.5 X 22mm Headed Screw, Short Thread
P20-145-024S	Monster 4.5 X 24mm Headed Screw, Short Thread
P20-145-026S	Monster 4.5 X 26mm Headed Screw, Short Thread
P20-145-028S	Monster 4.5 X 28mm Headed Screw, Short Thread
P20-145-030S	Monster 4.5 X 30mm Headed Screw, Short Thread
P20-145-032S	Monster 4.5 X 32mm Headed Screw, Short Thread
P20-145-034S	Monster 4.5 X 34mm Headed Screw, Short Thread
P20-145-036S	Monster 4.5 X 36mm Headed Screw, Short Thread
P20-145-038S	Monster 4.5 X 38mm Headed Screw, Short Thread
P20-145-040S	Monster 4.5 X 40mm Headed Screw, Short Thread
P20-145-042S	Monster 4.5 X 42mm Headed Screw, Short Thread
P20-145-044S	Monster 4.5 X 44mm Headed Screw, Short Thread
P20-145-046S	Monster 4.5 X 46mm Headed Screw, Short Thread
P20-145-048S	Monster 4.5 X 48mm Headed Screw, Short Thread
P20-145-050S	Monster 4.5 X 50mm Headed Screw, Short Thread
P20-145-055S	Monster 4.5 X 55mm Headed Screw, Short Thread
P20-145-060S	Monster 4.5 X 60mm Headed Screw, Short Thread
P20-145-065S	Monster 4.5 X 65mm Headed Screw, Short Thread
P20-145-070S	Monster 4.5 X 70mm Headed Screw, Short Thread
P20-545-018S	Monster 4.5 X 18mm Headless Screw, Short Thread
P20-545-020S	Monster 4.5 X 20mm Headless Screw, Short Thread
P20-545-022S	Monster 4.5 X 22mm Headless Screw, Short Thread
P20-545-024S	Monster 4.5 X 24mm Headless Screw, Short Thread
P20-545-026S	Monster 4.5 X 26mm Headless Screw, Short Thread
P20-545-028S	Monster 4.5 X 28mm Headless Screw, Short Thread
P20-545-030S	Monster 4.5 X 30mm Headless Screw, Short Thread
P20-545-032S	Monster 4.5 X 32mm Headless Screw, Short Thread

Not all products available for sale in all markets. To determine availability in your marketplace, please contact your local Paragon 28 representative or email info@paragon28.com.

4.5 MONSTER® HINDFOOT SCREWS (STAINLESS STEEL CADDY)

PART NUMBER	DESCRIPTION
P20-545-034S	Monster 4.5 X 34mm Headless Screw, Short Thread
P20-545-036S	Monster 4.5 X 36mm Headless Screw, Short Thread
P20-545-038S	Monster 4.5 X 38mm Headless Screw, Short Thread
P20-545-040S	Monster 4.5 X 40mm Headless Screw, Short Thread
P20-545-042S	Monster 4.5 X 42mm Headless Screw, Short Thread
P20-545-044S	Monster 4.5 X 44mm Headless Screw, Short Thread
P20-545-046S	Monster 4.5 X 46mm Headless Screw, Short Thread
P20-545-048S	Monster 4.5 X 48mm Headless Screw, Short Thread
P20-545-050S	Monster 4.5 X 50mm Headless Screw, Short Thread
P20-545-055S	Monster 4.5 X 55mm Headless Screw, Short Thread
P20-545-060S	Monster 4.5 X 60mm Headless Screw, Short Thread
P20-545-065S	Monster 4.5 X 65mm Headless Screw, Short Thread
P20-545-070S	Monster 4.5 X 70mm Headless Screw, Short Thread
P20-145-020L	Monster 4.5 X 20mm Headed Screw, Long Thread
P20-145-022L	Monster 4.5 X 22mm Headed Screw, Long Thread
P20-145-024L	Monster 4.5 X 24mm Headed Screw, Long Thread
P20-145-026L	Monster 4.5 X 26mm Headed Screw, Long Thread
P20-145-028L	Monster 4.5 X 28mm Headed Screw, Long Thread
P20-145-030L	Monster 4.5 X 30mm Headed Screw, Long Thread
P20-145-032L	Monster 4.5 X 32mm Headed Screw, Long Thread
P20-145-034L	Monster 4.5 X 34mm Headed Screw, Long Thread
P20-145-036L	Monster 4.5 X 36mm Headed Screw, Long Thread
P20-145-038L	Monster 4.5 X 38mm Headed Screw, Long Thread
P20-145-040L	Monster 4.5 X 40mm Headed Screw, Long Thread
P20-145-042L	Monster 4.5 X 42mm Headed Screw, Long Thread
P20-145-044L	Monster 4.5 X 44mm Headed Screw, Long Thread
P20-145-046L	Monster 4.5 X 46mm Headed Screw, Long Thread
P20-145-048L	Monster 4.5 X 48mm Headed Screw, Long Thread
P20-145-050L	Monster 4.5 X 50mm Headed Screw, Long Thread
P20-145-055L	Monster 4.5 X 55mm Headed Screw, Long Thread
P20-145-060L	Monster 4.5 X 60mm Headed Screw, Long Thread
P20-145-065L	Monster 4.5 X 65mm Headed Screw, Long Thread
P20-145-070L	Monster 4.5 X 70mm Headed Screw, Long Thread
P20-545-030L	Monster 4.5 X 30mm Headless Screw, Long Thread
P20-545-032L	Monster 4.5 X 32mm Headless Screw, Long Thread
P20-545-034L	Monster 4.5 X 34mm Headless Screw, Long Thread
P20-545-036L	Monster 4.5 X 36mm Headless Screw, Long Thread
P20-545-038L	Monster 4.5 X 38mm Headless Screw, Long Thread
P20-545-040L	Monster 4.5 X 40mm Headless Screw, Long Thread
P20-545-042L	Monster 4.5 X 42mm Headless Screw, Long Thread

Not all products available for sale in all markets. To determine availability in your marketplace, please contact your local Paragon 28 representative or email info@paragon28.com.

4.5 MONSTER® HINDFOOT SCREWS (STAINLESS STEEL CADDY)

PART NUMBER	DESCRIPTION
P20-545-044L	Monster 4.5 X 44mm Headless Screw, Long Thread
P20-545-046L	Monster 4.5 X 46mm Headless Screw, Long Thread
P20-545-048L	Monster 4.5 X 48mm Headless Screw, Long Thread
P20-545-050L	Monster 4.5 X 50mm Headless Screw, Long Thread
P20-545-055L	Monster 4.5 X 55mm Headless Screw, Long Thread
P20-545-060L	Monster 4.5 X 60mm Headless Screw, Long Thread
P20-545-065L	Monster 4.5 X 65mm Headless Screw, Long Thread
P20-545-070L	Monster 4.5 X 70mm Headless Screw, Long Thread
P20-145-018F	Monster 4.5 X 18mm Headed Screw, Full Thread
P20-145-020F	Monster 4.5 X 20mm Headed Screw, Full Thread
P20-145-022F	Monster 4.5 X 22mm Headed Screw, Full Thread
P20-145-024F	Monster 4.5 X 24mm Headed Screw, Full Thread
P20-145-026F	Monster 4.5 X 26mm Headed Screw, Full Thread
P20-145-028F	Monster 4.5 X 28mm Headed Screw, Full Thread
P20-145-030F	Monster 4.5 X 30mm Headed Screw, Full Thread
P20-145-032F	Monster 4.5 X 32mm Headed Screw, Full Thread
P20-145-034F	Monster 4.5 X 34mm Headed Screw, Full Thread
P20-145-036F	Monster 4.5 X 36mm Headed Screw, Full Thread
P20-145-038F	Monster 4.5 X 38mm Headed Screw, Full Thread
P20-145-040F	Monster 4.5 X 40mm Headed Screw, Full Thread
P20-145-042F	Monster 4.5 X 42mm Headed Screw, Full Thread
P20-145-044F	Monster 4.5 X 44mm Headed Screw, Full Thread
P20-145-046F	Monster 4.5 X 46mm Headed Screw, Full Thread
P20-145-048F	Monster 4.5 X 48mm Headed Screw, Full Thread
P20-145-050F	Monster 4.5 X 50mm Headed Screw, Full Thread
P20-145-055F	Monster 4.5 X 55mm Headed Screw, Full Thread
P20-145-060F	Monster 4.5 X 60mm Headed Screw, Full Thread
P20-145-065F	Monster 4.5 X 65mm Headed Screw, Full Thread
P20-145-070F	Monster 4.5 X 70mm Headed Screw, Full Thread



Not all products available for sale in all markets. To determine availability in your marketplace, please contact your local Paragon 28 representative or email info@paragon28.com.



5.5 mm Headed and Headless Monster® Screws

5.5 MONSTER® HINDFOOT SCREWS (STAINLESS STEEL CADDY)

PART NUMBER	DESCRIPTION
P20-901-2022	Monster 5.5mm Combination Screw Caddy, Stainless Steel
P20-155-026S	Monster 5.5 X 26mm Headed Screw, Short Thread
P20-155-028S	Monster 5.5 X 28mm Headed Screw, Short Thread
P20-155-030S	Monster 5.5 X 30mm Headed Screw, Short Thread
P20-155-032S	Monster 5.5 X 32mm Headed Screw, Short Thread
P20-155-034S	Monster 5.5 X 34mm Headed Screw, Short Thread
P20-155-036S	Monster 5.5 X 36mm Headed Screw, Short Thread
P20-155-038S	Monster 5.5 X 38mm Headed Screw, Short Thread
P20-155-040S	Monster 5.5 X 40mm Headed Screw, Short Thread
P20-155-042S	Monster 5.5 X 42mm Headed Screw, Short Thread
P20-155-044S	Monster 5.5 X 44mm Headed Screw, Short Thread
P20-155-046S	Monster 5.5 X 46mm Headed Screw, Short Thread
P20-155-048S	Monster 5.5 X 48mm Headed Screw, Short Thread
P20-155-050S	Monster 5.5 X 50mm Headed Screw, Short Thread
P20-155-052S	Monster 5.5 X 52mm Headed Screw, Short Thread
P20-155-054S	Monster 5.5 X 54mm Headed Screw, Short Thread
P20-155-056S	Monster 5.5 X 56mm Headed Screw, Short Thread
P20-155-058S	Monster 5.5 X 58mm Headed Screw, Short Thread
P20-155-060S	Monster 5.5 X 60mm Headed Screw, Short Thread
P20-155-065S	Monster 5.5 X 65mm Headed Screw, Short Thread
P20-155-070S	Monster 5.5 X 70mm Headed Screw, Short Thread
P20-155-075S	Monster 5.5 X 75mm Headed Screw, Short Thread
P20-155-080S	Monster 5.5 X 80mm Headed Screw, Short Thread
P20-155-085S	Monster 5.5 X 85mm Headed Screw, Short Thread
P20-155-090S	Monster 5.5 X 90mm Headed Screw, Short Thread
P20-555-026S	Monster 5.5 X 26mm Headless Screw, Short Thread
P20-555-028S	Monster 5.5 X 28mm Headless Screw, Short Thread
P20-555-030S	Monster 5.5 X 30mm Headless Screw, Short Thread
P20-555-032S	Monster 5.5 X 32mm Headless Screw, Short Thread
P20-555-034S	Monster 5.5 X 34mm Headless Screw, Short Thread

Not all products available for sale in all markets. To determine availability in your marketplace, please contact your local Paragon 28 representative or email info@paragon28.com.

5.5 MONSTER® HINDFOOT SCREWS (STAINLESS STEEL CADDY)

PART NUMBER	DESCRIPTION
P20-555-036S	Monster 5.5 X 36mm Headless Screw, Short Thread
P20-555-038S	Monster 5.5 X 38mm Headless Screw, Short Thread
P20-555-040S	Monster 5.5 X 40mm Headless Screw, Short Thread
P20-555-042S	Monster 5.5 X 42mm Headless Screw, Short Thread
P20-555-044S	Monster 5.5 X 44mm Headless Screw, Short Thread
P20-555-046S	Monster 5.5 X 46mm Headless Screw, Short Thread
P20-555-048S	Monster 5.5 X 48mm Headless Screw, Short Thread
P20-555-050S	Monster 5.5 X 50mm Headless Screw, Short Thread
P20-555-052S	Monster 5.5 X 52mm Headless Screw, Short Thread
P20-555-054S	Monster 5.5 X 54mm Headless Screw, Short Thread
P20-555-056S	Monster 5.5 X 56mm Headless Screw, Short Thread
P20-555-058S	Monster 5.5 X 58mm Headless Screw, Short Thread
P20-555-060S	Monster 5.5 X 60mm Headless Screw, Short Thread
P20-555-065S	Monster 5.5 X 65mm Headless Screw, Short Thread
P20-555-070S	Monster 5.5 X 70mm Headless Screw, Short Thread
P20-555-075S	Monster 5.5 X 75mm Headless Screw, Short Thread
P20-555-080S	Monster 5.5 X 80mm Headless Screw, Short Thread
P20-555-085S	Monster 5.5 X 85mm Headless Screw, Short Thread
P20-555-090S	Monster 5.5 X 90mm Headless Screw, Short Thread
P20-155-040L	Monster 5.5 X 40mm Headed Screw, Long Thread
P20-155-042L	Monster 5.5 X 42mm Headed Screw, Long Thread
P20-155-044L	Monster 5.5 X 44mm Headed Screw, Long Thread
P20-155-046L	Monster 5.5 X 46mm Headed Screw, Long Thread
P20-155-048L	Monster 5.5 X 48mm Headed Screw, Long Thread
P20-155-050L	Monster 5.5 X 50mm Headed Screw, Long Thread
P20-155-052L	Monster 5.5 X 52mm Headed Screw, Long Thread
P20-155-054L	Monster 5.5 X 54mm Headed Screw, Long Thread
P20-155-056L	Monster 5.5 X 56mm Headed Screw, Long Thread
P20-155-058L	Monster 5.5 X 58mm Headed Screw, Long Thread
P20-155-060L	Monster 5.5 X 60mm Headed Screw, Long Thread
P20-155-065L	Monster 5.5 X 65mm Headed Screw, Long Thread
P20-155-070L	Monster 5.5 X 70mm Headed Screw, Long Thread
P20-155-075L	Monster 5.5 X 75mm Headed Screw, Long Thread
P20-155-080L	Monster 5.5 X 80mm Headed Screw, Long Thread
P20-155-085L	Monster 5.5 X 85mm Headed Screw, Long Thread
P20-155-090L	Monster 5.5 X 90mm Headed Screw, Long Thread
P20-555-040L	Monster 5.5 X 40mm Headless Screw, Long Thread
P20-555-042L	Monster 5.5 X 42mm Headless Screw, Long Thread
P20-555-044L	Monster 5.5 X 44mm Headless Screw, Long Thread
P20-555-046L	Monster 5.5 X 46mm Headless Screw, Long Thread

Not all products available for sale in all markets. To determine availability in your marketplace, please contact your local Paragon 28 representative or email info@paragon28.com.

5.5 MONSTER® HINDFOOT SCREWS (STAINLESS STEEL CADDY)

PART NUMBER	DESCRIPTION
P20-555-048L	Monster 5.5 X 48mm Headless Screw, Long Thread
P20-555-050L	Monster 5.5 X 50mm Headless Screw, Long Thread
P20-555-052L	Monster 5.5 X 52mm Headless Screw, Long Thread
P20-555-054L	Monster 5.5 X 54mm Headless Screw, Long Thread
P20-555-056L	Monster 5.5 X 56mm Headless Screw, Long Thread
P20-555-058L	Monster 5.5 X 58mm Headless Screw, Long Thread
P20-555-060L	Monster 5.5 X 60mm Headless Screw, Long Thread
P20-555-065L	Monster 5.5 X 65mm Headless Screw, Long Thread
P20-555-070L	Monster 5.5 X 70mm Headless Screw, Long Thread
P20-555-075L	Monster 5.5 X 75mm Headless Screw, Long Thread
P20-555-080L	Monster 5.5 X 80mm Headless Screw, Long Thread
P20-555-085L	Monster 5.5 X 85mm Headless Screw, Long Thread
P20-555-090L	Monster 5.5 X 90mm Headless Screw, Long Thread
P20-155-026F	Monster 5.5 X 26mm Headed Screw, Full Thread
P20-155-028F	Monster 5.5 X 28mm Headed Screw, Full Thread
P20-155-030F	Monster 5.5 X 30mm Headed Screw, Full Thread
P20-155-032F	Monster 5.5 X 32mm Headed Screw, Full Thread
P20-155-034F	Monster 5.5 X 34mm Headed Screw, Full Thread
P20-155-036F	Monster 5.5 X 36mm Headed Screw, Full Thread
P20-155-038F	Monster 5.5 X 38mm Headed Screw, Full Thread
P20-155-040F	Monster 5.5 X 40mm Headed Screw, Full Thread
P20-155-042F	Monster 5.5 X 42mm Headed Screw, Full Thread
P20-155-044F	Monster 5.5 X 44mm Headed Screw, Full Thread
P20-155-046F	Monster 5.5 X 46mm Headed Screw, Full Thread
P20-155-048F	Monster 5.5 X 48mm Headed Screw, Full Thread
P20-155-050F	Monster 5.5 X 50mm Headed Screw, Full Thread
P20-155-052F	Monster 5.5 X 52mm Headed Screw, Full Thread
P20-155-054F	Monster 5.5 X 54mm Headed Screw, Full Thread
P20-155-056F	Monster 5.5 X 56mm Headed Screw, Full Thread
P20-155-058F	Monster 5.5 X 58mm Headed Screw, Full Thread
P20-155-060F	Monster 5.5 X 60mm Headed Screw, Full Thread
P20-155-065F	Monster 5.5 X 65mm Headed Screw, Full Thread
P20-155-070F	Monster 5.5 X 70mm Headed Screw, Full Thread
P20-155-075F	Monster 5.5 X 75mm Headed Screw, Full Thread
P20-155-080F	Monster 5.5 X 80mm Headed Screw, Full Thread
P20-155-085F	Monster 5.5 X 85mm Headed Screw, Full Thread
P20-155-090F	Monster 5.5 X 90mm Headed Screw, Full Thread



Not all products available for sale in all markets. To determine availability in your marketplace, please contact your local Paragon 28 representative or email info@paragon28.com.



7.0 mm Headed and Headless Monster® Screws

7.0 MONSTER® HINDFOOT SCREWS (STAINLESS STEEL CADDY)

PART NUMBER	DESCRIPTION
P20-901-2010-01	Monster 7.0mm Combination Screw Caddy, Stainless Steel, Base Assembly
P20-901-2010-02	Monster 7.0mm Combination Screw Caddy, Stainless Steel, Lid
P20-170-040S	7.0 x 40 mm Headed, Cannulated, Short Thread Screw
P20-170-044S	7.0 x 44 mm Headed, Cannulated, Short Thread Screw
P20-170-048S	7.0 x 48 mm Headed, Cannulated, Short Thread Screw
P20-170-050S	7.0 x 50 mm Headed, Cannulated, Short Thread Screw
P20-170-055S	7.0 x 55 mm Headed, Cannulated, Short Thread Screw
P20-170-060S	7.0 x 60 mm Headed, Cannulated, Short Thread Screw
P20-170-065S	7.0 x 65 mm Headed, Cannulated, Short Thread Screw
P20-170-070S	7.0 x 70 mm Headed, Cannulated, Short Thread Screw
P20-170-074S	7.0 x 74 mm Headed, Cannulated, Short Thread Screw
P20-170-078S	7.0 x 78 mm Headed, Cannulated, Short Thread Screw
P20-170-080S	7.0 x 80 mm Headed, Cannulated, Short Thread Screw
P20-170-084S	7.0 x 84 mm Headed, Cannulated, Short Thread Screw
P20-170-088S	7.0 x 88 mm Headed, Cannulated, Short Thread Screw
P20-170-090S	7.0 x 90 mm Headed, Cannulated, Short Thread Screw
P20-170-095S	7.0 x 95 mm Headed, Cannulated, Short Thread Screw
P20-170-100S	7.0 x 100 mm Headed, Cannulated, Short Thread Screw
P20-170-105S	7.0 x 105 mm Headed, Cannulated, Short Thread Screw
P20-170-110S	7.0 x 110 mm Headed, Cannulated, Short Thread Screw
P20-170-115S	7.0 x 115 mm Headed, Cannulated, Short Thread Screw
P20-170-120S	7.0 x 120 mm Headed, Cannulated, Short Thread Screw
P20-570-040S	7.0 x 40 mm Headless, Cannulated, Short Thread Screw
P20-570-044S	7.0 x 44 mm Headless, Cannulated, Short Thread Screw
P20-570-048S	7.0 x 48 mm Headless, Cannulated, Short Thread Screw
P20-570-050S	7.0 x 50 mm Headless, Cannulated, Short Thread Screw
P20-570-055S	7.0 x 55 mm Headless, Cannulated, Short Thread Screw
P20-570-060S	7.0 x 60 mm Headless, Cannulated, Short Thread Screw
P20-570-065S	7.0 x 65 mm Headless, Cannulated, Short Thread Screw
P20-570-070S	7.0 x 70 mm Headless, Cannulated, Short Thread Screw

Not all products available for sale in all markets. To determine availability in your marketplace, please contact your local Paragon 28 representative or email info@paragon28.com.

7.0 MONSTER® HINDFOOT SCREWS (STAINLESS STEEL CADDY)

PART NUMBER	DESCRIPTION
P20-570-074S	7.0 x 74 mm Headless, Cannulated, Short Thread Screw
P20-570-078S	7.0 x 78 mm Headless, Cannulated, Short Thread Screw
P20-570-080S	7.0 x 80 mm Headless, Cannulated, Short Thread Screw
P20-570-084S	7.0 x 84 mm Headless, Cannulated, Short Thread Screw
P20-570-088S	7.0 x 88 mm Headless, Cannulated, Short Thread Screw
P20-570-090S	7.0 x 90 mm Headless, Cannulated, Short Thread Screw
P20-570-095S	7.0 x 95 mm Headless, Cannulated, Short Thread Screw
P20-570-100S	7.0 x 100 mm Headless, Cannulated, Short Thread Screw
P20-570-105S	7.0 x 105 mm Headless, Cannulated, Short Thread Screw
P20-570-110S	7.0 x 110 mm Headless, Cannulated, Short Thread Screw
P20-570-115S	7.0 x 115 mm Headless, Cannulated, Short Thread Screw
P20-570-120S	7.0 x 120 mm Headless, Cannulated, Short Thread Screw
P20-170-040M	7.0 x 40 mm Headed, Cannulated, Medium Thread Screw
P20-170-044M	7.0 x 44 mm Headed, Cannulated, Medium Thread Screw
P20-170-048M	7.0 x 48 mm Headed, Cannulated, Medium Thread Screw
P20-170-050M	7.0 x 50 mm Headed, Cannulated, Medium Thread Screw
P20-170-055M	7.0 x 55 mm Headed, Cannulated, Medium Thread Screw
P20-170-060M	7.0 x 60 mm Headed, Cannulated, Medium Thread Screw
P20-170-065M	7.0 x 65 mm Headed, Cannulated, Medium Thread Screw
P20-170-070M	7.0 x 70 mm Headed, Cannulated, Medium Thread Screw
P20-170-074M	7.0 x 74 mm Headed, Cannulated, Medium Thread Screw
P20-170-078M	7.0 x 78 mm Headed, Cannulated, Medium Thread Screw
P20-170-080M	7.0 x 80 mm Headed, Cannulated, Medium Thread Screw
P20-170-084M	7.0 x 84 mm Headed, Cannulated, Medium Thread Screw
P20-170-088M	7.0 x 88 mm Headed, Cannulated, Medium Thread Screw
P20-170-090M	7.0 x 90 mm Headed, Cannulated, Medium Thread Screw
P20-170-095M	7.0 x 95 mm Headed, Cannulated, Medium Thread Screw
P20-170-100M	7.0 x 100 mm Headed, Cannulated, Medium Thread Screw
P20-170-105M	7.0 x 105 mm Headed, Cannulated, Medium Thread Screw
P20-170-110M	7.0 x 110 mm Headed, Cannulated, Medium Thread Screw
P20-170-115M	7.0 x 115 mm Headed, Cannulated, Medium Thread Screw
P20-170-120M	7.0 x 120 mm Headed, Cannulated, Medium Thread Screw
P20-570-044M	7.0 x 44 mm Headless, Cannulated, Medium Thread Screw
P20-570-048M	7.0 x 48 mm Headless, Cannulated, Medium Thread Screw
P20-570-050M	7.0 x 50 mm Headless, Cannulated, Medium Thread Screw
P20-570-055M	7.0 x 55 mm Headless, Cannulated, Medium Thread Screw
P20-570-060M	7.0 x 60 mm Headless, Cannulated, Medium Thread Screw
P20-570-065M	7.0 x 65 mm Headless, Cannulated, Medium Thread Screw
P20-570-070M	7.0 x 70 mm Headless, Cannulated, Medium Thread Screw
P20-570-074M	7.0 x 74 mm Headless, Cannulated, Medium Thread Screw

Not all products available for sale in all markets. To determine availability in your marketplace, please contact your local Paragon 28 representative or email info@paragon28.com.

7.0 MONSTER® HINDFOOT SCREWS (STAINLESS STEEL CADDY)

PART NUMBER	DESCRIPTION
P20-570-078M	7.0 x 78 mm Headless, Cannulated, Medium Thread Screw
P20-570-080M	7.0 x 80 mm Headless, Cannulated, Medium Thread Screw
P20-570-084M	7.0 x 84 mm Headless, Cannulated, Medium Thread Screw
P20-570-088M	7.0 x 88 mm Headless, Cannulated, Medium Thread Screw
P20-570-090M	7.0 x 90 mm Headless, Cannulated, Medium Thread Screw
P20-570-095M	7.0 x 95 mm Headless, Cannulated, Medium Thread Screw
P20-570-100M	7.0 x 100 mm Headless, Cannulated, Medium Thread Screw
P20-570-105M	7.0 x 105 mm Headless, Cannulated, Medium Thread Screw
P20-570-110M	7.0 x 110 mm Headless, Cannulated, Medium Thread Screw
P20-570-115M	7.0 x 115 mm Headless, Cannulated, Medium Thread Screw
P20-570-120M	7.0 x 120 mm Headless, Cannulated, Medium Thread Screw
P20-170-050L	7.0 x 50 mm Headed, Cannulated, Long Thread Screw
P20-170-055L	7.0 x 55 mm Headed, Cannulated, Long Thread Screw
P20-170-060L	7.0 x 60 mm Headed, Cannulated, Long Thread Screw
P20-170-065L	7.0 x 65 mm Headed, Cannulated, Long Thread Screw
P20-170-070L	7.0 x 70 mm Headed, Cannulated, Long Thread Screw
P20-170-074L	7.0 x 74 mm Headed, Cannulated, Long Thread Screw
P20-170-078L	7.0 x 78 mm Headed, Cannulated, Long Thread Screw
P20-170-080L	7.0 x 80 mm Headed, Cannulated, Long Thread Screw
P20-170-084L	7.0 x 84 mm Headed, Cannulated, Long Thread Screw
P20-170-088L	7.0 x 88 mm Headed, Cannulated, Long Thread Screw
P20-170-090L	7.0 x 90 mm Headed, Cannulated, Long Thread Screw
P20-170-095L	7.0 x 95 mm Headed, Cannulated, Long Thread Screw
P20-570-060L	7.0 x 60 mm Headless, Cannulated, Long Thread Screw
P20-570-065L	7.0 x 65 mm Headless, Cannulated, Long Thread Screw
P20-570-070L	7.0 x 70 mm Headless, Cannulated, Long Thread Screw
P20-570-074L	7.0 x 74 mm Headless, Cannulated, Long Thread Screw
P20-570-078L	7.0 x 78 mm Headless, Cannulated, Long Thread Screw
P20-570-080L	7.0 x 80 mm Headless, Cannulated, Long Thread Screw
P20-570-084L	7.0 x 84 mm Headless, Cannulated, Long Thread Screw
P20-570-088L	7.0 x 88 mm Headless, Cannulated, Long Thread Screw
P20-570-090L	7.0 x 90 mm Headless, Cannulated, Long Thread Screw
P20-570-095L	7.0 x 95 mm Headless, Cannulated, Long Thread Screw
P20-570-100L	7.0 x 100 mm Headless, Cannulated, Long Thread Screw
P20-570-105L	7.0 x 105 mm Headless, Cannulated, Long Thread Screw
P20-570-110L	7.0 x 110 mm Headless, Cannulated, Long Thread Screw
P20-570-115L	7.0 x 115 mm Headless, Cannulated, Long Thread Screw
P20-570-120L	7.0 x 120 mm Headless, Cannulated, Long Thread Screw
P20-170-050F	7.0 x 50 mm Headed, Cannulated, Full Thread Screw
P20-170-055F	7.0 x 55 mm Headed, Cannulated, Full Thread Screw

Not all products available for sale in all markets. To determine availability in your marketplace, please contact your local Paragon 28 representative or email info@paragon28.com.

7.0 MONSTER® HINDFOOT SCREWS (STAINLESS STEEL CADDY)

PART NUMBER	DESCRIPTION
P20-170-060F	7.0 x 60 mm Headed, Cannulated, Full Thread Screw
P20-170-065F	7.0 x 65 mm Headed, Cannulated, Full Thread Screw
P20-170-070F	7.0 x 70 mm Headed, Cannulated, Full Thread Screw
P20-170-074F	7.0 x 74 mm Headed, Cannulated, Full Thread Screw
P20-170-078F	7.0 x 78 mm Headed, Cannulated, Full Thread Screw
P20-170-080F	7.0 x 80 mm Headed, Cannulated, Full Thread Screw
P20-170-084F	7.0 x 84 mm Headed, Cannulated, Full Thread Screw
P20-170-088F	7.0 x 88 mm Headed, Cannulated, Full Thread Screw
P20-170-090F	7.0 x 90 mm Headed, Cannulated, Full Thread Screw
P20-170-095F	7.0 x 95 mm Headed, Cannulated, Full Thread Screw



Not all products available for sale in all markets. To determine availability in your marketplace, please contact your local Paragon 28 representative or email info@paragon28.com.

MONSTER STAINLESS STEEL INSTRUMENTS

PART NUMBER	DESCRIPTION
P50-900-5001	P28 Caddy Lid, Half DIN Caddies
P50-900-5002	P28 Caddy Base, Half DIN Caddies
P99-900-1007	Footplate
P20-900-7004	Caddy, Insert, Monster Instrument, Upper Tray
P99-110-2914	Drill, 2.9 x 140 mm Long, Cannulated, 3/16 Sq. (4.5 HF)
P99-110-3516	Drill, 3.5 x 160 mm Long, Cannulated, 3/16 Sq (5.5 HF)
P99-110-4622	Drill, 4.6 x 220 mm Long, Cannulated, 3/16 Sq (7.0 HF)
P99-998-0014	1.4 mm Monster Screw Cannulated Cleaning Stylet
P99-998-0023	7.0mm Monster Screw 2.3mm Cleaning Stylet
P99-192-1415	1.4 x 150 mm, K-wire, Single Ended Trocar Tip, SMOOTH
P99-192-1615	1.6 x 150 mm, K-wire, Single Ended Trocar Tip, SMOOTH
P99-193-1415	1.4 x 150 mm, K-wire, THREADED
P99-193-1615	1.6 x 150 mm, K-wire, THREADED
P99-192-2323	2.3 x 230 mm, K-wire, Single Ended Trocar Tip, SMOOTH
P99-193-2323	2.3 x 230 mm, K-wire, Single Ended Trocar Tip, THREADED
P99-194-2323	2.3 x 230 mm, K-wire, Single Trocar Tip, SMOOTH, w/ FlouroBand
P99-195-2323	2.3 x 230 mm, K-wire, Single Trocar Tip, THREADED, w/ FlouroBand
P20-910-4500	4.5 mm Monster Screw HEADED Countersink
P20-910-5500	5.5 mm Monster Screw HEADED Countersink
P20-910-7000	7.0 mm Monster Screw HEADED Countersink
P20-915-4500	4.5 mm Monster Screw HEADLESS Countersink
P20-915-5500	5.5 mm Monster Screw HEADLESS Countersink
P20-915-7000	7.0mm Monster Screw HEADLESS Countersink
P20-920-4500	4.5 mm Monster Screw Tap
P20-920-5500	5.5 mm Monster Screw Tap
P20-920-7000	7.0 mm Monster Screw Tap
P20-900-7003	Caddy, Insert, Monster Instrument, Middle Tray
P99-110-7020	Overdrill, cannulated, 7.0 x 200mm
P20-930-7000	7.0 mm Tissue Protector
P20-931-7000	7.0 mm Drill Guide
P20-932-4500	1.4 mm K-wire Guide
P20-932-5500	1.6 mm K-wire Guide
P20-932-7000	2.3 mm K-wire Guide
P20-935-7000	7.0 mm Parallel K-wire Drill Guide
P20-940-4555	4.5/5.5 Double-Ended Drill Guide
P20-952-4555	4.5 & 5.5 MONSTER DEPTH GAUGE
P20-952-7000	Monster 7.0 Depth Gauge
P99-110-4511	Overdrill, cannulated, 4.5 x 110mm
P99-110-5513	Overdrill, cannulated, 3/16 sq connection, 5.5 x 130mm
P99-150-0001	Screw Forceps

Not all products available for sale in all markets. To determine availability in your marketplace, please contact your local Paragon 28 representative or email info@paragon28.com.

MONSTER STAINLESS STEEL INSTRUMENTS

PART NUMBER	DESCRIPTION
P20-910-WB70	Monster, Countersink, 7.0mm, Bowl Washer
P20-900-7002	Caddy, Insert, Monster Instrument, Lower Tray
P99-150-0010	Hintermann Hindfoot Distractor, 2.5 & 3.0 K-wire
P99-190-TX15	TX-15 Monster Screw Cannulated Driver
P99-190-TX25	TX-25 Monster Screw Cannulated Driver
P99-190-TX30	TX-30 Monster Screw Cannulated Driver
P99-190-TX30-17	TX-30, 170mm Long Monster Screw Cannulated Driver
P99-000-316A	3/16 Sq to Jacobs Adapter
P99-000-316L	Axial Ratcheting Handle, LARGE, 3/16 Sq ADPT
P99-000-316M	Axial Ratcheting Handle, MEDIUM, 3/16 Sq ADPT
P20-045-WD00	Dome Washer for Monster Screw 4.5mm
P20-045-WF00	Flat Washer for Monster Screw 4.5mm
P20-055-WD00	Dome Washer for Monster Screw 5.5mm
P20-055-WF00	Flat Washer for Monster Screw 5.5mm
P20-070-WD00	Dome Washer for Monster Screw 7.0mm
P20-070-WF00	Flat Washer for Monster Screw 7.0mm
P20-070-WFS0	Monster, Washer, 7.0mm Slotted
P20-070-WB00	Monster Screw Bowl Washer, 7.0 mm
MS70CI-XXX	Monster Hindfoot 7.0 Ø Combination, Stainless Screw Caddy, OUS
MS55CI-XXX	Monster Hindfoot 5.5 Ø Combination, Stainless Screw Caddy, OUS
MS45CI-XXX	Monster Hindfoot 4.5 Ø Combination, Stainless Screw Caddy, OUS

Section 25:
**STERILE PACKAGED
PRODUCT**

Not all products available for sale in all markets. To determine availability in your marketplace, please contact your local Paragon 28 representative or email info@paragon28.com.

STERILE PACKAGED PRODUCT

PART NUMBER	DESCRIPTION
P20-020-DW00-S	Mini-Monster® Washer, Deep Well, Ø2.0 Sterile
P20-025-DW00-S	Mini-Monster® Washer, Deep Well, Ø2.5 Sterile
P20-030-DW00-S	Mini-Monster® Washer, Deep Well, Ø3.0 Sterile
P20-035-DW00-S	Mini-Monster® Washer, Deep Well, Ø3.5 Sterile
P20-040-DW00-S	Mini-Monster® Washer, Deep Well, Ø4.0 Sterile
P20-045-WD00-S	Monster® Dome Washer, 4.5mm Sterile
P20-045-WF00-S	Monster® Flat Washer, 4.5mm Sterile
P20-055-WD00-S	Monster® Dome Washer, 5.5mm Sterile
P20-055-WF00-S	Monster® Flat Washer, 5.5mm Sterile
P20-070-WB00-S	Monster® Bowl Washer, 7.0mm Sterile
P20-070-WD00-S	Monster® Dome Washer, 7.0mm Sterile
P20-070-WF00-S	Monster® Flat Washer, 7.0mm Sterile
P20-070-WFS0-S	Monster® Slotted Bowl Washer, 7.0mm Sterile
P20-120-008F-S	Mini-Monster® Cannulated Screw, Full Thread, Headed, Ø2.0 x 8mm Sterile
P20-120-008S-S	Mini-Monster® Cannulated Screw, Short Thread, Headed, Ø2.0 x 8mm Sterile
P20-120-009F-S	Mini-Monster® Cannulated Screw, Full Thread, Headed, Ø2.0 x 9mm Sterile
P20-120-009S-S	Mini-Monster® Cannulated Screw, Short Thread, Headed, Ø2.0 x 9mm Sterile
P20-120-010F-S	Mini-Monster® Cannulated Screw, Full Thread, Headed, Ø2.0 x 10mm Sterile
P20-120-010S-S	Mini-Monster® Cannulated Screw, Short Thread, Headed, Ø2.0 x 10mm Sterile
P20-120-011F-S	Mini-Monster® Cannulated Screw, Full Thread, Headed, Ø2.0 x 11mm Sterile
P20-120-011S-S	Mini-Monster® Cannulated Screw, Short Thread, Headed, Ø2.0 x 11mm Sterile
P20-120-012F-S	Mini-Monster® Cannulated Screw, Full Thread, Headed, Ø2.0 x 12mm Sterile
P20-120-012S-S	Mini-Monster® Cannulated Screw, Short Thread, Headed, Ø2.0 x 12mm Sterile
P20-120-013F-S	Mini-Monster® Cannulated Screw, Full Thread, Headed, Ø2.0 x 13mm Sterile
P20-120-013S-S	Mini-Monster® Cannulated Screw, Short Thread, Headed, Ø2.0 x 13mm Sterile
P20-120-014F-S	Mini-Monster® Cannulated Screw, Full Thread, Headed, Ø2.0 x 14mm Sterile
P20-120-014S-S	Mini-Monster® Cannulated Screw, Short Thread, Headed, Ø2.0 x 14mm Sterile
P20-120-015F-S	Mini-Monster® Cannulated Screw, Full Thread, Headed, Ø2.0 x 15mm Sterile
P20-120-015S-S	Mini-Monster® Cannulated Screw, Short Thread, Headed, Ø2.0 x 15mm Sterile
P20-120-016F-S	Mini-Monster® Cannulated Screw, Full Thread, Headed, Ø2.0 x 16mm Sterile
P20-120-016S-S	Mini-Monster® Cannulated Screw, Short Thread, Headed, Ø2.0 x 16mm Sterile
P20-120-017F-S	Mini-Monster® Cannulated Screw, Full Thread, Headed, Ø2.0 x 17mm Sterile
P20-120-017S-S	Mini-Monster® Cannulated Screw, Short Thread, Headed, Ø2.0 x 17mm Sterile
P20-120-018F-S	Mini-Monster® Cannulated Screw, Full Thread, Headed, Ø2.0 x 18mm Sterile
P20-120-018S-S	Mini-Monster® Cannulated Screw, Short Thread, Headed, Ø2.0 x 18mm Sterile
P20-120-019F-S	Mini-Monster® Cannulated Screw, Full Thread, Headed, Ø2.0 x 19mm Sterile
P20-120-019S-S	Mini-Monster® Cannulated Screw, Short Thread, Headed, Ø2.0 x 19mm Sterile
P20-120-020F-S	Mini-Monster® Cannulated Screw, Full Thread, Headed, Ø2.0 x 20mm Sterile
P20-120-020S-S	Mini-Monster® Cannulated Screw, Short Thread, Headed, Ø2.0 x 20mm Sterile
P20-120-022F-S	Mini-Monster® Cannulated Screw, Full Thread, Headed, Ø2.0 x 22mm Sterile

Not all products available for sale in all markets. To determine availability in your marketplace, please contact your local Paragon 28 representative or email info@paragon28.com.

STERILE PACKAGED PRODUCT

PART NUMBER	DESCRIPTION
P20-120-022S-S	Mini-Monster® Cannulated Screw, Short Thread, Headed, Ø2.0 x 22mm Sterile
P20-120-024F-S	Mini-Monster® Cannulated Screw, Full Thread, Headed, Ø2.0 x 24mm Sterile
P20-120-024S-S	Mini-Monster® Cannulated Screw, Short Thread, Headed, Ø2.0 x 24mm Sterile
P20-120-026F-S	Mini-Monster® Cannulated Screw, Full Thread, Headed, Ø2.0 x 26mm Sterile
P20-120-026S-S	Mini-Monster® Cannulated Screw, Short Thread, Headed, Ø2.0 x 26mm Sterile
P20-120-028F-S	Mini-Monster® Cannulated Screw, Full Thread, Headed, Ø2.0 x 28mm Sterile
P20-120-028S-S	Mini-Monster® Cannulated Screw, Short Thread, Headed, Ø2.0 x 28mm Sterile
P20-120-030F-S	Mini-Monster® Cannulated Screw, Full Thread, Headed, Ø2.0 x 30mm Sterile
P20-120-030S-S	Mini-Monster® Cannulated Screw, Short Thread, Headed, Ø2.0 x 30mm Sterile
P20-120-032F-S	Mini-Monster® Cannulated Screw, Full Thread, Headed, Ø2.0 x 32mm Sterile
P20-120-032S-S	Mini-Monster® Cannulated Screw, Short Thread, Headed, Ø2.0 x 32mm Sterile
P20-120-034F-S	Mini-Monster® Cannulated Screw, Full Thread, Headed, Ø2.0 x 34mm Sterile
P20-120-034S-S	Mini-Monster® Cannulated Screw, Short Thread, Headed, Ø2.0 x 34mm Sterile
P20-120-036F-S	Mini-Monster® Cannulated Screw, Full Thread, Headed, Ø2.0 x 36mm Sterile
P20-120-036S-S	Mini-Monster® Cannulated Screw, Short Thread, Headed, Ø2.0 x 36mm Sterile
P20-120-038F-S	Mini-Monster® Cannulated Screw, Full Thread, Headed, Ø2.0 x 38mm Sterile
P20-120-038S-S	Mini-Monster® Cannulated Screw, Short Thread, Headed, Ø2.0 x 38mm Sterile
P20-120-040F-S	Mini-Monster® Cannulated Screw, Full Thread, Headed, Ø2.0 x 40mm Sterile
P20-120-040S-S	Mini-Monster® Cannulated Screw, Short Thread, Headed, Ø2.0 x 40mm Sterile
P20-120-042F-S	Mini-Monster® Cannulated Screw, Full Thread, Headed, Ø2.0 x 42mm Sterile
P20-120-042S-S	Mini-Monster® Cannulated Screw, Short Thread, Headed, Ø2.0 x 42mm Sterile
P20-120-044F-S	Mini-Monster® Cannulated Screw, Full Thread, Headed, Ø2.0 x 44mm Sterile
P20-120-044S-S	Mini-Monster® Cannulated Screw, Short Thread, Headed, Ø2.0 x 44mm Sterile
P20-120-046F-S	Mini-Monster® Cannulated Screw, Full Thread, Headed, Ø2.0 x 46mm Sterile
P20-120-046S-S	Mini-Monster® Cannulated Screw, Short Thread, Headed, Ø2.0 x 46mm Sterile
P20-120-048F-S	Mini-Monster® Cannulated Screw, Full Thread, Headed, Ø2.0 x 48mm Sterile
P20-120-048S-S	Mini-Monster® Cannulated Screw, Short Thread, Headed, Ø2.0 x 48mm Sterile
P20-120-050F-S	Mini-Monster® Cannulated Screw, Full Thread, Headed, Ø2.0 x 50mm Sterile
P20-120-050S-S	Mini-Monster® Cannulated Screw, Short Thread, Headed, Ø2.0 x 50mm Sterile
P20-125-010F-S	Mini-Monster® Cannulated Screw, Full Thread, Headed, Ø2.5 x 10 mm Sterile
P20-125-010S-S	Mini-Monster® Cannulated Screw, Short Thread, Headed, Ø2.5 x 10 mm Sterile
P20-125-011F-S	Mini-Monster® Cannulated Screw, Full Thread, Headed, Ø2.5 x 11 mm Sterile
P20-125-011S-S	Mini-Monster® Cannulated Screw, Short Thread, Headed, Ø2.5 x 11 mm Sterile
P20-125-012F-S	Mini-Monster® Cannulated Screw, Full Thread, Headed, Ø2.5 x 12 mm Sterile
P20-125-012S-S	Mini-Monster® Cannulated Screw, Short Thread, Headed, Ø2.5 x 12 mm Sterile
P20-125-013F-S	Mini-Monster® Cannulated Screw, Full Thread, Headed, Ø2.5 x 13 mm Sterile
P20-125-013S-S	Mini-Monster® Cannulated Screw, Short Thread, Headed, Ø2.5 x 13 mm Sterile
P20-125-014F-S	Mini-Monster® Cannulated Screw, Full Thread, Headed, Ø2.5 x 14 mm Sterile
P20-125-014S-S	Mini-Monster® Cannulated Screw, Short Thread, Headed, Ø2.5 x 14 mm Sterile
P20-125-015F-S	Mini-Monster® Cannulated Screw, Full Thread, Headed, Ø2.5 x 15 mm Sterile

Not all products available for sale in all markets. To determine availability in your marketplace, please contact your local Paragon 28 representative or email info@paragon28.com.

STERILE PACKAGED PRODUCT

PART NUMBER	DESCRIPTION
P20-125-015S-S	Mini-Monster® Cannulated Screw, Short Thread, Headed, Ø2.5 x 15 mm Sterile
P20-125-016F-S	Mini-Monster® Cannulated Screw, Full Thread, Headed, Ø2.5 x 16 mm Sterile
P20-125-016S-S	Mini-Monster® Cannulated Screw, Short Thread, Headed, Ø2.5 x 16 mm Sterile
P20-125-017F-S	Mini-Monster® Cannulated Screw, Full Thread, Headed, Ø2.5 x 17 mm Sterile
P20-125-017S-S	Mini-Monster® Cannulated Screw, Short Thread, Headed, Ø2.5 x 17 mm Sterile
P20-125-018F-S	Mini-Monster® Cannulated Screw, Full Thread, Headed, Ø2.5 x 18 mm Sterile
P20-125-018S-S	Mini-Monster® Cannulated Screw, Short Thread, Headed, Ø2.5 x 18 mm Sterile
P20-125-019F-S	Mini-Monster® Cannulated Screw, Full Thread, Headed, Ø2.5 x 19 mm Sterile
P20-125-019S-S	Mini-Monster® Cannulated Screw, Short Thread, Headed, Ø2.5 x 19 mm Sterile
P20-125-020F-S	Mini-Monster® Cannulated Screw, Full Thread, Headed, Ø2.5 x 20 mm Sterile
P20-125-020S-S	Mini-Monster® Cannulated Screw, Short Thread, Headed, Ø2.5 x 20 mm Sterile
P20-125-022F-S	Mini-Monster® Cannulated Screw, Full Thread, Headed, Ø2.5 x 22 mm Sterile
P20-125-022S-S	Mini-Monster® Cannulated Screw, Short Thread, Headed, Ø2.5 x 22 mm Sterile
P20-125-024F-S	Mini-Monster® Cannulated Screw, Full Thread, Headed, Ø2.5 x 24 mm Sterile
P20-125-024S-S	Mini-Monster® Cannulated Screw, Short Thread, Headed, Ø2.5 x 24 mm Sterile
P20-125-026F-S	Mini-Monster® Cannulated Screw, Full Thread, Headed, Ø2.5 x 26 mm Sterile
P20-125-026S-S	Mini-Monster® Cannulated Screw, Short Thread, Headed, Ø2.5 x 26 mm Sterile
P20-125-028F-S	Mini-Monster® Cannulated Screw, Full Thread, Headed, Ø2.5 x 28 mm Sterile
P20-125-028S-S	Mini-Monster® Cannulated Screw, Short Thread, Headed, Ø2.5 x 28 mm Sterile
P20-125-030F-S	Mini-Monster® Cannulated Screw, Full Thread, Headed, Ø2.5 x 30 mm Sterile
P20-125-030S-S	Mini-Monster® Cannulated Screw, Short Thread, Headed, Ø2.5 x 30 mm Sterile
P20-125-032F-S	Mini-Monster® Cannulated Screw, Full Thread, Headed, Ø2.5 x 32 mm Sterile
P20-125-032S-S	Mini-Monster® Cannulated Screw, Short Thread, Headed, Ø2.5 x 32 mm Sterile
P20-125-034F-S	Mini-Monster® Cannulated Screw, Full Thread, Headed, Ø2.5 x 34 mm Sterile
P20-125-034S-S	Mini-Monster® Cannulated Screw, Short Thread, Headed, Ø2.5 x 34 mm Sterile
P20-125-036F-S	Mini-Monster® Cannulated Screw, Full Thread, Headed, Ø2.5 x 36 mm Sterile
P20-125-036S-S	Mini-Monster® Cannulated Screw, Short Thread, Headed, Ø2.5 x 36 mm Sterile
P20-125-038F-S	Mini-Monster® Cannulated Screw, Full Thread, Headed, Ø2.5 x 38 mm Sterile
P20-125-038S-S	Mini-Monster® Cannulated Screw, Short Thread, Headed, Ø2.5 x 38 mm Sterile
P20-125-040F-S	Mini-Monster® Cannulated Screw, Full Thread, Headed, Ø2.5 x 40 mm Sterile
P20-125-040S-S	Mini-Monster® Cannulated Screw, Short Thread, Headed, Ø2.5 x 40 mm Sterile
P20-125-042F-S	Mini-Monster® Cannulated Screw, Full Thread, Headed, Ø2.5 x 42 mm Sterile
P20-125-042S-S	Mini-Monster® Cannulated Screw, Short Thread, Headed, Ø2.5 x 42 mm Sterile
P20-125-044F-S	Mini-Monster® Cannulated Screw, Full Thread, Headed, Ø2.5 x 44 mm Sterile
P20-125-044S-S	Mini-Monster® Cannulated Screw, Short Thread, Headed, Ø2.5 x 44 mm Sterile
P20-125-046F-S	Mini-Monster® Cannulated Screw, Full Thread, Headed, Ø2.5 x 46 mm Sterile
P20-125-046S-S	Mini-Monster® Cannulated Screw, Short Thread, Headed, Ø2.5 x 46 mm Sterile
P20-125-048F-S	Mini-Monster® Cannulated Screw, Full Thread, Headed, Ø2.5 x 48 mm Sterile
P20-125-048S-S	Mini-Monster® Cannulated Screw, Short Thread, Headed, Ø2.5 x 48 mm Sterile
P20-125-050F-S	Mini-Monster® Cannulated Screw, Full Thread, Headed, Ø2.5 x 50 mm Sterile

Not all products available for sale in all markets. To determine availability in your marketplace, please contact your local Paragon 28 representative or email info@paragon28.com.

STERILE PACKAGED PRODUCT

PART NUMBER	DESCRIPTION
P20-125-050S-S	Mini-Monster® Cannulated Screw, Short Thread, Headed, Ø2.5 x 50 mm Sterile
P20-130-010F-S	Mini-Monster® Cannulated Screw, Full Thread, Headed Ø3.0 x 10mm Sterile
P20-130-010S-S	Mini-Monster® Cannulated Screw, Short Thread, Headed Ø3.0 x 10mm Sterile
P20-130-012F-S	Mini-Monster® Cannulated Screw, Full Thread, Headed Ø3.0 x 12mm Sterile
P20-130-012S-S	Mini-Monster® Cannulated Screw, Short Thread, Headed Ø3.0 x 12mm Sterile
P20-130-014F-S	Mini-Monster® Cannulated Screw, Full Thread, Headed Ø3.0 x 14mm Sterile
P20-130-014S-S	Mini-Monster® Cannulated Screw, Short Thread, Headed Ø3.0 x 14mm Sterile
P20-130-016F-S	Mini-Monster® Cannulated Screw, Full Thread, Headed Ø3.0 x 16mm Sterile
P20-130-016S-S	Mini-Monster® Cannulated Screw, Short Thread, Headed Ø3.0 x 16mm Sterile
P20-130-018F-S	Mini-Monster® Cannulated Screw, Full Thread, Headed Ø3.0 x 18mm Sterile
P20-130-018S-S	Mini-Monster® Cannulated Screw, Short Thread, Headed Ø3.0 x 18mm Sterile
P20-130-020F-S	Mini-Monster® Cannulated Screw, Full Thread, Headed Ø3.0 x 20mm Sterile
P20-130-020S-S	Mini-Monster® Cannulated Screw, Short Thread, Headed Ø3.0 x 20mm Sterile
P20-130-022F-S	Mini-Monster® Cannulated Screw, Full Thread, Headed Ø3.0 x 22mm Sterile
P20-130-022S-S	Mini-Monster® Cannulated Screw, Short Thread, Headed Ø3.0 x 22mm Sterile
P20-130-024F-S	Mini-Monster® Cannulated Screw, Full Thread, Headed Ø3.0 x 24mm Sterile
P20-130-024S-S	Mini-Monster® Cannulated Screw, Short Thread, Headed Ø3.0 x 24mm Sterile
P20-130-026F-S	Mini-Monster® Cannulated Screw, Full Thread, Headed Ø3.0 x 26mm Sterile
P20-130-026S-S	Mini-Monster® Cannulated Screw, Short Thread, Headed Ø3.0 x 26mm Sterile
P20-130-028F-S	Mini-Monster® Cannulated Screw, Full Thread, Headed Ø3.0 x 28mm Sterile
P20-130-028S-S	Mini-Monster® Cannulated Screw, Short Thread, Headed Ø3.0 x 28mm Sterile
P20-130-030F-S	Mini-Monster® Cannulated Screw, Full Thread, Headed Ø3.0 x 30mm Sterile
P20-130-030S-S	Mini-Monster® Cannulated Screw, Short Thread, Headed Ø3.0 x 30mm Sterile
P20-130-032F-S	Mini-Monster® Cannulated Screw, Full Thread, Headed Ø3.0 x 32mm Sterile
P20-130-032S-S	Mini-Monster® Cannulated Screw, Short Thread, Headed Ø3.0 x 32mm Sterile
P20-130-034F-S	Mini-Monster® Cannulated Screw, Full Thread, Headed Ø3.0 x 34mm Sterile
P20-130-034S-S	Mini-Monster® Cannulated Screw, Short Thread, Headed Ø3.0 x 34mm Sterile
P20-130-036F-S	Mini-Monster® Cannulated Screw, Full Thread, Headed Ø3.0 x 36mm Sterile
P20-130-036S-S	Mini-Monster® Cannulated Screw, Short Thread, Headed Ø3.0 x 36mm Sterile
P20-130-038F-S	Mini-Monster® Cannulated Screw, Full Thread, Headed Ø3.0 x 38mm Sterile
P20-130-038S-S	Mini-Monster® Cannulated Screw, Short Thread, Headed Ø3.0 x 38mm Sterile
P20-130-040F-S	Mini-Monster® Cannulated Screw, Full Thread, Headed Ø3.0 x 40mm Sterile
P20-130-040S-S	Mini-Monster® Cannulated Screw, Short Thread, Headed Ø3.0 x 40mm Sterile
P20-130-042F-S	Mini-Monster® Cannulated Screw, Full Thread, Headed Ø3.0 x 42mm Sterile
P20-130-042S-S	Mini-Monster® Cannulated Screw, Short Thread, Headed Ø3.0 x 42mm Sterile
P20-130-044F-S	Mini-Monster® Cannulated Screw, Full Thread, Headed Ø3.0 x 44mm Sterile
P20-130-044S-S	Mini-Monster® Cannulated Screw, Short Thread, Headed Ø3.0 x 44mm Sterile
P20-130-046F-S	Mini-Monster® Cannulated Screw, Full Thread, Headed Ø3.0 x 46mm Sterile
P20-130-046S-S	Mini-Monster® Cannulated Screw, Short Thread, Headed Ø3.0 x 46mm Sterile
P20-130-048F-S	Mini-Monster® Cannulated Screw, Full Thread, Headed Ø3.0 x 48mm Sterile

Not all products available for sale in all markets. To determine availability in your marketplace, please contact your local Paragon 28 representative or email info@paragon28.com.

STERILE PACKAGED PRODUCT

PART NUMBER	DESCRIPTION
P20-130-048S-S	Mini-Monster® Cannulated Screw, Short Thread, Headed Ø3.0 x 48mm Sterile
P20-130-050F-S	Mini-Monster® Cannulated Screw, Full Thread, Headed Ø3.0 x 50mm Sterile
P20-130-050S-S	Mini-Monster® Cannulated Screw, Short Thread, Headed Ø3.0 x 50mm Sterile
P20-135-010F-S	Mini-Monster® Cannulated Screw, Full Thread, Headed, Ø3.5 x 10 mm Sterile
P20-135-010S-S	Mini-Monster® Cannulated Screw, Short Thread, Headed, Ø3.5 x 10 mm Sterile
P20-135-012F-S	Mini-Monster® Cannulated Screw, Full Thread, Headed, Ø3.5 x 12 mm Sterile
P20-135-012S-S	Mini-Monster® Cannulated Screw, Short Thread, Headed, Ø3.5 x 12 mm Sterile
P20-135-014F-S	Mini-Monster® Cannulated Screw, Full Thread, Headed, Ø3.5 x 14 mm Sterile
P20-135-014S-S	Mini-Monster® Cannulated Screw, Short Thread, Headed, Ø3.5 x 14 mm Sterile
P20-135-016F-S	Mini-Monster® Cannulated Screw, Full Thread, Headed, Ø3.5 x 16 mm Sterile
P20-135-016S-S	Mini-Monster® Cannulated Screw, Short Thread, Headed, Ø3.5 x 16 mm Sterile
P20-135-018F-S	Mini-Monster® Cannulated Screw, Full Thread, Headed, Ø3.5 x 18 mm Sterile
P20-135-018S-S	Mini-Monster® Cannulated Screw, Short Thread, Headed, Ø3.5 x 18 mm Sterile
P20-135-020F-S	Mini-Monster® Cannulated Screw, Full Thread, Headed, Ø3.5 x 20 mm Sterile
P20-135-020S-S	Mini-Monster® Cannulated Screw, Short Thread, Headed, Ø3.5 x 20 mm Sterile
P20-135-022F-S	Mini-Monster® Cannulated Screw, Full Thread, Headed, Ø3.5 x 22 mm Sterile
P20-135-022S-S	Mini-Monster® Cannulated Screw, Short Thread, Headed, Ø3.5 x 22 mm Sterile
P20-135-024F-S	Mini-Monster® Cannulated Screw, Full Thread, Headed, Ø3.5 x 24 mm Sterile
P20-135-024S-S	Mini-Monster® Cannulated Screw, Short Thread, Headed, Ø3.5 x 24 mm Sterile
P20-135-026F-S	Mini-Monster® Cannulated Screw, Full Thread, Headed, Ø3.5 x 26 mm Sterile
P20-135-026S-S	Mini-Monster® Cannulated Screw, Short Thread, Headed, Ø3.5 x 26 mm Sterile
P20-135-028F-S	Mini-Monster® Cannulated Screw, Full Thread, Headed, Ø3.5 x 28 mm Sterile
P20-135-028S-S	Mini-Monster® Cannulated Screw, Short Thread, Headed, Ø3.5 x 28 mm Sterile
P20-135-030F-S	Mini-Monster® Cannulated Screw, Full Thread, Headed, Ø3.5 x 30 mm Sterile
P20-135-030S-S	Mini-Monster® Cannulated Screw, Short Thread, Headed, Ø3.5 x 30 mm Sterile
P20-135-032F-S	Mini-Monster® Cannulated Screw, Full Thread, Headed, Ø3.5 x 32 mm Sterile
P20-135-032S-S	Mini-Monster® Cannulated Screw, Short Thread, Headed, Ø3.5 x 32 mm Sterile
P20-135-034F-S	Mini-Monster® Cannulated Screw, Full Thread, Headed, Ø3.5 x 34 mm Sterile
P20-135-034S-S	Mini-Monster® Cannulated Screw, Short Thread, Headed, Ø3.5 x 34 mm Sterile
P20-135-036F-S	Mini-Monster® Cannulated Screw, Full Thread, Headed, Ø3.5 x 36 mm Sterile
P20-135-036S-S	Mini-Monster® Cannulated Screw, Short Thread, Headed, Ø3.5 x 36 mm Sterile
P20-135-038F-S	Mini-Monster® Cannulated Screw, Full Thread, Headed, Ø3.5 x 38 mm Sterile
P20-135-038S-S	Mini-Monster® Cannulated Screw, Short Thread, Headed, Ø3.5 x 38 mm Sterile
P20-135-040F-S	Mini-Monster® Cannulated Screw, Full Thread, Headed, Ø3.5 x 40 mm Sterile
P20-135-040S-S	Mini-Monster® Cannulated Screw, Short Thread, Headed, Ø3.5 x 40 mm Sterile
P20-135-042F-S	Mini-Monster® Cannulated Screw, Full Thread, Headed, Ø3.5 x 42 mm Sterile
P20-135-042S-S	Mini-Monster® Cannulated Screw, Short Thread, Headed, Ø3.5 x 42 mm Sterile
P20-135-044F-S	Mini-Monster® Cannulated Screw, Full Thread, Headed, Ø3.5 x 44 mm Sterile
P20-135-044S-S	Mini-Monster® Cannulated Screw, Short Thread, Headed, Ø3.5 x 44 mm Sterile
P20-135-046F-S	Mini-Monster® Cannulated Screw, Full Thread, Headed, Ø3.5 x 46 mm Sterile

Not all products available for sale in all markets. To determine availability in your marketplace, please contact your local Paragon 28 representative or email info@paragon28.com.

STERILE PACKAGED PRODUCT

PART NUMBER	DESCRIPTION
P20-135-046S-S	Mini-Monster® Cannulated Screw, Short Thread, Headed, Ø3.5 x 46 mm Sterile
P20-135-048F-S	Mini-Monster® Cannulated Screw, Full Thread, Headed, Ø3.5 x 48 mm Sterile
P20-135-048S-S	Mini-Monster® Cannulated Screw, Short Thread, Headed, Ø3.5 x 48 mm Sterile
P20-135-050F-S	Mini-Monster® Cannulated Screw, Full Thread, Headed, Ø3.5 x 50 mm Sterile
P20-135-050S-S	Mini-Monster® Cannulated Screw, Short Thread, Headed, Ø3.5 x 50 mm Sterile
P20-140-012F-S	Mini-Monster® Cannulated Screw, Full Thread, Headed, Ø4.0 x 12 mm Sterile
P20-140-012S-S	Mini-Monster® Cannulated Screw, Short Thread, Headed, Ø4.0 x 12 mm Sterile
P20-140-014F-S	Mini-Monster® Cannulated Screw, Full Thread, Headed, Ø4.0 x 14 mm Sterile
P20-140-014S-S	Mini-Monster® Cannulated Screw, Short Thread, Headed, Ø4.0 x 14 mm Sterile
P20-140-016F-S	Mini-Monster® Cannulated Screw, Full Thread, Headed, Ø4.0 x 16 mm Sterile
P20-140-016S-S	Mini-Monster® Cannulated Screw, Short Thread, Headed, Ø4.0 x 16 mm Sterile
P20-140-018F-S	Mini-Monster® Cannulated Screw, Full Thread, Headed, Ø4.0 x 18 mm Sterile
P20-140-018S-S	Mini-Monster® Cannulated Screw, Short Thread, Headed, Ø4.0 x 18 mm Sterile
P20-140-020F-S	Mini-Monster® Cannulated Screw, Full Thread, Headed, Ø4.0 x 20 mm Sterile
P20-140-020S-S	Mini-Monster® Cannulated Screw, Short Thread, Headed, Ø4.0 x 20 mm Sterile
P20-140-022F-S	Mini-Monster® Cannulated Screw, Full Thread, Headed, Ø4.0 x 22 mm Sterile
P20-140-022S-S	Mini-Monster® Cannulated Screw, Short Thread, Headed, Ø4.0 x 22 mm Sterile
P20-140-024F-S	Mini-Monster® Cannulated Screw, Full Thread, Headed, Ø4.0 x 24 mm Sterile
P20-140-024S-S	Mini-Monster® Cannulated Screw, Short Thread, Headed, Ø4.0 x 24 mm Sterile
P20-140-026F-S	Mini-Monster® Cannulated Screw, Full Thread, Headed, Ø4.0 x 26 mm Sterile
P20-140-026S-S	Mini-Monster® Cannulated Screw, Short Thread, Headed, Ø4.0 x 26 mm Sterile
P20-140-028F-S	Mini-Monster® Cannulated Screw, Full Thread, Headed, Ø4.0 x 28 mm Sterile
P20-140-028L-S	Mini-Monster® Cannulated Screw, Long Thread, Headed, Ø4.0 x 28 mm Sterile
P20-140-028S-S	Mini-Monster® Cannulated Screw, Short Thread, Headed, Ø4.0 x 28 mm Sterile
P20-140-030F-S	Mini-Monster® Cannulated Screw, Full Thread, Headed, Ø4.0 x 30 mm Sterile
P20-140-030L-S	Mini-Monster® Cannulated Screw, Long Thread, Headed, Ø4.0 x 30 mm Sterile
P20-140-030S-S	Mini-Monster® Cannulated Screw, Short Thread, Headed, Ø4.0 x 30 mm Sterile
P20-140-032F-S	Mini-Monster® Cannulated Screw, Full Thread, Headed, Ø4.0 x 32 mm Sterile
P20-140-032L-S	Mini-Monster® Cannulated Screw, Long Thread, Headed, Ø4.0 x 32 mm Sterile
P20-140-032S-S	Mini-Monster® Cannulated Screw, Short Thread, Headed, Ø4.0 x 32 mm Sterile
P20-140-034F-S	Mini-Monster® Cannulated Screw, Full Thread, Headed, Ø4.0 x 34 mm Sterile
P20-140-034L-S	Mini-Monster® Cannulated Screw, Long Thread, Headed, Ø4.0 x 34 mm Sterile
P20-140-034S-S	Mini-Monster® Cannulated Screw, Short Thread, Headed, Ø4.0 x 34 mm Sterile
P20-140-036F-S	Mini-Monster® Cannulated Screw, Full Thread, Headed, Ø4.0 x 36 mm Sterile
P20-140-036L-S	Mini-Monster® Cannulated Screw, Long Thread, Headed, Ø4.0 x 36 mm Sterile
P20-140-036S-S	Mini-Monster® Cannulated Screw, Short Thread, Headed, Ø4.0 x 36 mm Sterile
P20-140-038F-S	Mini-Monster® Cannulated Screw, Full Thread, Headed, Ø4.0 x 38 mm Sterile
P20-140-038L-S	Mini-Monster® Cannulated Screw, Long Thread, Headed, Ø4.0 x 38 mm Sterile
P20-140-038S-S	Mini-Monster® Cannulated Screw, Short Thread, Headed, Ø4.0 x 38 mm Sterile
P20-140-040F-S	Mini-Monster® Cannulated Screw, Full Thread, Headed, Ø4.0 x 40 mm Sterile

Not all products available for sale in all markets. To determine availability in your marketplace, please contact your local Paragon 28 representative or email info@paragon28.com.

STERILE PACKAGED PRODUCT

PART NUMBER	DESCRIPTION
P20-140-040L-S	Mini-Monster® Cannulated Screw, Long Thread, Headed, Ø4.0 x 40 mm Sterile
P20-140-040S-S	Mini-Monster® Cannulated Screw, Short Thread, Headed, Ø4.0 x 40 mm Sterile
P20-140-042F-S	Mini-Monster® Cannulated Screw, Full Thread, Headed, Ø4.0 x 42 mm Sterile
P20-140-042L-S	Mini-Monster® Cannulated Screw, Long Thread, Headed, Ø4.0 x 42 mm Sterile
P20-140-042S-S	Mini-Monster® Cannulated Screw, Short Thread, Headed, Ø4.0 x 42 mm Sterile
P20-140-044F-S	Mini-Monster® Cannulated Screw, Full Thread, Headed, Ø4.0 x 44 mm Sterile
P20-140-044L-S	Mini-Monster® Cannulated Screw, Long Thread, Headed, Ø4.0 x 44 mm Sterile
P20-140-044S-S	Mini-Monster® Cannulated Screw, Short Thread, Headed, Ø4.0 x 44 mm Sterile
P20-140-046F-S	Mini-Monster® Cannulated Screw, Full Thread, Headed, Ø4.0 x 46 mm Sterile
P20-140-046L-S	Mini-Monster® Cannulated Screw, Long Thread, Headed, Ø4.0 x 46 mm Sterile
P20-140-046S-S	Mini-Monster® Cannulated Screw, Short Thread, Headed, Ø4.0 x 46 mm Sterile
P20-140-048F-S	Mini-Monster® Cannulated Screw, Full Thread, Headed, Ø4.0 x 48 mm Sterile
P20-140-048L-S	Mini-Monster® Cannulated Screw, Long Thread, Headed, Ø4.0 x 48 mm Sterile
P20-140-048S-S	Mini-Monster® Cannulated Screw, Short Thread, Headed, Ø4.0 x 48 mm Sterile
P20-140-050F-S	Mini-Monster® Cannulated Screw, Full Thread, Headed, Ø4.0 x 50 mm Sterile
P20-140-050L-S	Mini-Monster® Cannulated Screw, Long Thread, Headed, Ø4.0 x 50 mm Sterile
P20-140-050S-S	Mini-Monster® Cannulated Screw, Short Thread, Headed, Ø4.0 x 50 mm Sterile
P20-140-055F-S	Mini-Monster® Cannulated Screw, Full Thread, Headed, Ø4.0 x 55 mm Sterile
P20-140-055L-S	Mini-Monster® Cannulated Screw, Long Thread, Headed, Ø4.0 x 55 mm Sterile
P20-140-055S-S	Mini-Monster® Cannulated Screw, Short Thread, Headed, Ø4.0 x 55 mm Sterile
P20-140-060F-S	Mini-Monster® Cannulated Screw, Full Thread, Headed, Ø4.0 x 60 mm Sterile
P20-140-060L-S	Mini-Monster® Cannulated Screw, Long Thread, Headed, Ø4.0 x 60 mm Sterile
P20-140-060S-S	Mini-Monster® Cannulated Screw, Short Thread, Headed, Ø4.0 x 60 mm Sterile
P20-145-018F-S	Monster® Cannulated Screw, Full Thread, Headed, Ø4.5 x 18 mm Sterile
P20-145-018S-S	Monster® Cannulated Screw, Short Thread, Headed, Ø4.5 x 18 mm Sterile
P20-145-020F-S	Monster® Cannulated Screw, Full Thread, Headed, Ø4.5 x 20 mm Sterile
P20-145-020L-S	Monster® Cannulated Screw, Long Thread, Headed, Ø4.5 x 20 mm Sterile
P20-145-020S-S	Monster® Cannulated Screw, Short Thread, Headed, Ø4.5 x 20 mm Sterile
P20-145-022F-S	Monster® Cannulated Screw, Full Thread, Headed, Ø4.5 x 22 mm Sterile
P20-145-022L-S	Monster® Cannulated Screw, Long Thread, Headed, Ø4.5 x 22 mm Sterile
P20-145-022S-S	Monster® Cannulated Screw, Short Thread, Headed, Ø4.5 x 22 mm Sterile
P20-145-024F-S	Monster® Cannulated Screw, Full Thread, Headed, Ø4.5 x 24 mm Sterile
P20-145-024L-S	Monster® Cannulated Screw, Long Thread, Headed, Ø4.5 x 24 mm Sterile
P20-145-024S-S	Monster® Cannulated Screw, Short Thread, Headed, Ø4.5 x 24 mm Sterile
P20-145-026F-S	Monster® Cannulated Screw, Full Thread, Headed, Ø4.5 x 26 mm Sterile
P20-145-026L-S	Monster® Cannulated Screw, Long Thread, Headed, Ø4.5 x 26 mm Sterile
P20-145-026S-S	Monster® Cannulated Screw, Short Thread, Headed, Ø4.5 x 26 mm Sterile
P20-145-028F-S	Monster® Cannulated Screw, Full Thread, Headed, Ø4.5 x 28 mm Sterile
P20-145-028L-S	Monster® Cannulated Screw, Long Thread, Headed, Ø4.5 x 28 mm Sterile
P20-145-028S-S	Monster® Cannulated Screw, Short Thread, Headed, Ø4.5 x 28 mm Sterile

Not all products available for sale in all markets. To determine availability in your marketplace, please contact your local Paragon 28 representative or email info@paragon28.com.

STERILE PACKAGED PRODUCT

PART NUMBER	DESCRIPTION
P20-145-030F-S	Monster® Cannulated Screw, Full Thread, Headed, Ø4.5 x 30 mm Sterile
P20-145-030L-S	Monster® Cannulated Screw, Long Thread, Headed, Ø4.5 x 30 mm Sterile
P20-145-030S-S	Monster® Cannulated Screw, Short Thread, Headed, Ø4.5 x 30 mm Sterile
P20-145-032F-S	Monster® Cannulated Screw, Full Thread, Headed, Ø4.5 x 32 mm Sterile
P20-145-032L-S	Monster® Cannulated Screw, Long Thread, Headed, Ø4.5 x 32 mm Sterile
P20-145-032S-S	Monster® Cannulated Screw, Short Thread, Headed, Ø4.5 x 32 mm Sterile
P20-145-034F-S	Monster® Cannulated Screw, Full Thread, Headed, Ø4.5 x 34 mm Sterile
P20-145-034L-S	Monster® Cannulated Screw, Long Thread, Headed, Ø4.5 x 34 mm Sterile
P20-145-034S-S	Monster® Cannulated Screw, Short Thread, Headed, Ø4.5 x 34 mm Sterile
P20-145-036F-S	Monster® Cannulated Screw, Full Thread, Headed, Ø4.5 x 36 mm Sterile
P20-145-036L-S	Monster® Cannulated Screw, Long Thread, Headed, Ø4.5 x 36 mm Sterile
P20-145-036S-S	Monster® Cannulated Screw, Short Thread, Headed, Ø4.5 x 36 mm Sterile
P20-145-038F-S	Monster® Cannulated Screw, Full Thread, Headed, Ø4.5 x 38 mm Sterile
P20-145-038L-S	Monster® Cannulated Screw, Long Thread, Headed, Ø4.5 x 38 mm Sterile
P20-145-038S-S	Monster® Cannulated Screw, Short Thread, Headed, Ø4.5 x 38 mm Sterile
P20-145-040F-S	Monster® Cannulated Screw, Full Thread, Headed, Ø4.5 x 40 mm Sterile
P20-145-040L-S	Monster® Cannulated Screw, Long Thread, Headed, Ø4.5 x 40 mm Sterile
P20-145-040S-S	Monster® Cannulated Screw, Short Thread, Headed, Ø4.5 x 40 mm Sterile
P20-145-042F-S	Monster® Cannulated Screw, Full Thread, Headed, Ø4.5 x 42 mm Sterile
P20-145-042L-S	Monster® Cannulated Screw, Long Thread, Headed, Ø4.5 x 42 mm Sterile
P20-145-042S-S	Monster® Cannulated Screw, Short Thread, Headed, Ø4.5 x 42 mm Sterile
P20-145-044F-S	Monster® Cannulated Screw, Full Thread, Headed, Ø4.5 x 44 mm Sterile
P20-145-044L-S	Monster® Cannulated Screw, Long Thread, Headed, Ø4.5 x 44 mm Sterile
P20-145-044S-S	Monster® Cannulated Screw, Short Thread, Headed, Ø4.5 x 44 mm Sterile
P20-145-046F-S	Monster® Cannulated Screw, Full Thread, Headed, Ø4.5 x 46 mm Sterile
P20-145-046L-S	Monster® Cannulated Screw, Long Thread, Headed, Ø4.5 x 46 mm Sterile
P20-145-046S-S	Monster® Cannulated Screw, Short Thread, Headed, Ø4.5 x 46 mm Sterile
P20-145-048F-S	Monster® Cannulated Screw, Full Thread, Headed, Ø4.5 x 48 mm Sterile
P20-145-048L-S	Monster® Cannulated Screw, Long Thread, Headed, Ø4.5 x 48 mm Sterile
P20-145-048S-S	Monster® Cannulated Screw, Short Thread, Headed, Ø4.5 x 48 mm Sterile
P20-145-050F-S	Monster® Cannulated Screw, Full Thread, Headed, Ø4.5 x 50 mm Sterile
P20-145-050L-S	Monster® Cannulated Screw, Long Thread, Headed, Ø4.5 x 50 mm Sterile
P20-145-050S-S	Monster® Cannulated Screw, Short Thread, Headed, Ø4.5 x 50 mm Sterile
P20-145-055F-S	Monster® Cannulated Screw, Full Thread, Headed, Ø4.5 x 55 mm Sterile
P20-145-055L-S	Monster® Cannulated Screw, Long Thread, Headed, Ø4.5 x 55 mm Sterile
P20-145-055S-S	Monster® Cannulated Screw, Short Thread, Headed, Ø4.5 x 55 mm Sterile
P20-145-060F-S	Monster® Cannulated Screw, Full Thread, Headed, Ø4.5 x 60 mm Sterile
P20-145-060L-S	Monster® Cannulated Screw, Long Thread, Headed, Ø4.5 x 60 mm Sterile
P20-145-060S-S	Monster® Cannulated Screw, Short Thread, Headed, Ø4.5 x 60 mm Sterile
P20-145-065F-S	Monster® Cannulated Screw, Full Thread, Headed, Ø4.5 x 65 mm Sterile

Not all products available for sale in all markets. To determine availability in your marketplace, please contact your local Paragon 28 representative or email info@paragon28.com.

STERILE PACKAGED PRODUCT

PART NUMBER	DESCRIPTION
P20-145-065L-S	Monster® Cannulated Screw, Long Thread, Headed, Ø4.5 x 65 mm Sterile
P20-145-065S-S	Monster® Cannulated Screw, Short Thread, Headed, Ø4.5 x 65 mm Sterile
P20-145-070F-S	Monster® Cannulated Screw, Full Thread, Headed, Ø4.5 x 70 mm Sterile
P20-145-070L-S	Monster® Cannulated Screw, Long Thread, Headed, Ø4.5 x 70 mm Sterile
P20-145-070S-S	Monster® Cannulated Screw, Short Thread, Headed, Ø4.5 x 70 mm Sterile
P20-155-026F-S	Monster® Cannulated Screw, Full Thread, Headed, Ø5.5 X 26mm Sterile
P20-155-026S-S	Monster® Cannulated Screw, Short Thread, Headed, Ø5.5 X 26mm Sterile
P20-155-028F-S	Monster® Cannulated Screw, Full Thread, Headed, Ø5.5 X 28mm Sterile
P20-155-028S-S	Monster® Cannulated Screw, Short Thread, Headed, Ø5.5 X 28mm Sterile
P20-155-030F-S	Monster® Cannulated Screw, Full Thread, Headed, Ø5.5 X 30mm Sterile
P20-155-030S-S	Monster® Cannulated Screw, Short Thread, Headed, Ø5.5 X 30mm Sterile
P20-155-032F-S	Monster® Cannulated Screw, Full Thread, Headed, Ø5.5 X 32mm Sterile
P20-155-032S-S	Monster® Cannulated Screw, Short Thread, Headed, Ø5.5 X 32mm Sterile
P20-155-034F-S	Monster® Cannulated Screw, Full Thread, Headed, Ø5.5 X 34mm Sterile
P20-155-034S-S	Monster® Cannulated Screw, Short Thread, Headed, Ø5.5 X 34mm Sterile
P20-155-036F-S	Monster® Cannulated Screw, Full Thread, Headed, Ø5.5 X 36mm Sterile
P20-155-036S-S	Monster® Cannulated Screw, Short Thread, Headed, Ø5.5 X 36mm Sterile
P20-155-038F-S	Monster® Cannulated Screw, Full Thread, Headed, Ø5.5 X 38mm Sterile
P20-155-038S-S	Monster® Cannulated Screw, Short Thread, Headed, Ø5.5 X 38mm Sterile
P20-155-040F-S	Monster® Cannulated Screw, Full Thread, Headed, Ø5.5 X 40mm Sterile
P20-155-040L-S	Monster® Cannulated Screw, Long Thread, Headed, Ø5.5 X 40mm Sterile
P20-155-040S-S	Monster® Cannulated Screw, Short Thread, Headed, Ø5.5 X 40mm Sterile
P20-155-042F-S	Monster® Cannulated Screw, Full Thread, Headed, Ø5.5 X 42mm Sterile
P20-155-042L-S	Monster® Cannulated Screw, Long Thread, Headed, Ø5.5 X 42mm Sterile
P20-155-042S-S	Monster® Cannulated Screw, Short Thread, Headed, Ø5.5 X 42mm Sterile
P20-155-044F-S	Monster® Cannulated Screw, Full Thread, Headed, Ø5.5 X 44mm Sterile
P20-155-044L-S	Monster® Cannulated Screw, Long Thread, Headed, Ø5.5 X 44mm Sterile
P20-155-044S-S	Monster® Cannulated Screw, Short Thread, Headed, Ø5.5 X 44mm Sterile
P20-155-046F-S	Monster® Cannulated Screw, Full Thread, Headed, Ø5.5 X 46mm Sterile
P20-155-046L-S	Monster® Cannulated Screw, Long Thread, Headed, Ø5.5 X 46mm Sterile
P20-155-046S-S	Monster® Cannulated Screw, Short Thread, Headed, Ø5.5 X 46mm Sterile
P20-155-048F-S	Monster® Cannulated Screw, Full Thread, Headed, Ø5.5 X 48mm Sterile
P20-155-048L-S	Monster® Cannulated Screw, Long Thread, Headed, Ø5.5 X 48mm Sterile
P20-155-048S-S	Monster® Cannulated Screw, Short Thread, Headed, Ø5.5 X 48mm Sterile
P20-155-050F-S	Monster® Cannulated Screw, Full Thread, Headed, Ø5.5 X 50mm Sterile
P20-155-050L-S	Monster® Cannulated Screw, Long Thread, Headed, Ø5.5 X 50mm Sterile
P20-155-050S-S	Monster® Cannulated Screw, Short Thread, Headed, Ø5.5 X 50mm Sterile
P20-155-052F-S	Monster® Cannulated Screw, Full Thread, Headed, Ø5.5 X 52mm Sterile
P20-155-052L-S	Monster® Cannulated Screw, Long Thread, Headed, Ø5.5 X 52mm Sterile
P20-155-052S-S	Monster® Cannulated Screw, Short Thread, Headed, Ø5.5 X 52mm Sterile

Not all products available for sale in all markets. To determine availability in your marketplace, please contact your local Paragon 28 representative or email info@paragon28.com.

STERILE PACKAGED PRODUCT

PART NUMBER	DESCRIPTION
P20-155-054F-S	Monster® Cannulated Screw, Full Thread, Headed, Ø5.5 X 54mm Sterile
P20-155-054L-S	Monster® Cannulated Screw, Long Thread, Headed, Ø5.5 X 54mm Sterile
P20-155-054S-S	Monster® Cannulated Screw, Short Thread, Headed, Ø5.5 X 54mm Sterile
P20-155-056F-S	Monster® Cannulated Screw, Full Thread, Headed, Ø5.5 X 56mm Sterile
P20-155-056L-S	Monster® Cannulated Screw, Long Thread, Headed, Ø5.5 X 56mm Sterile
P20-155-056S-S	Monster® Cannulated Screw, Short Thread, Headed, Ø5.5 X 56mm Sterile
P20-155-058F-S	Monster® Cannulated Screw, Full Thread, Headed, Ø5.5 X 58mm Sterile
P20-155-058L-S	Monster® Cannulated Screw, Long Thread, Headed, Ø5.5 X 58mm Sterile
P20-155-058S-S	Monster® Cannulated Screw, Short Thread, Headed, Ø5.5 X 58mm Sterile
P20-155-060F-S	Monster® Cannulated Screw, Full Thread, Headed, Ø5.5 X 60mm Sterile
P20-155-060L-S	Monster® Cannulated Screw, Long Thread, Headed, Ø5.5 X 60mm Sterile
P20-155-060S-S	Monster® Cannulated Screw, Short Thread, Headed, Ø5.5 X 60mm Sterile
P20-155-065F-S	Monster® Cannulated Screw, Full Thread, Headed, Ø5.5 X 65mm Sterile
P20-155-065L-S	Monster® Cannulated Screw, Long Thread, Headed, Ø5.5 X 65mm Sterile
P20-155-065S-S	Monster® Cannulated Screw, Short Thread, Headed, Ø5.5 X 65mm Sterile
P20-155-070F-S	Monster® Cannulated Screw, Full Thread, Headed, Ø5.5 X 70mm Sterile
P20-155-070L-S	Monster® Cannulated Screw, Long Thread, Headed, Ø5.5 X 70mm Sterile
P20-155-070S-S	Monster® Cannulated Screw, Short Thread, Headed, Ø5.5 X 70mm Sterile
P20-155-075F-S	Monster® Cannulated Screw, Full Thread, Headed, Ø5.5 X 75mm Sterile
P20-155-075L-S	Monster® Cannulated Screw, Long Thread, Headed, Ø5.5 X 75mm Sterile
P20-155-075S-S	Monster® Cannulated Screw, Short Thread, Headed, Ø5.5 X 75mm Sterile
P20-155-080F-S	Monster® Cannulated Screw, Full Thread, Headed, Ø5.5 X 80mm Sterile
P20-155-080L-S	Monster® Cannulated Screw, Long Thread, Headed, Ø5.5 X 80mm Sterile
P20-155-080S-S	Monster® Cannulated Screw, Short Thread, Headed, Ø5.5 X 80mm Sterile
P20-155-085F-S	Monster® Cannulated Screw, Full Thread, Headed, Ø5.5 X 85mm Sterile
P20-155-085L-S	Monster® Cannulated Screw, Long Thread, Headed, Ø5.5 X 85mm Sterile
P20-155-085S-S	Monster® Cannulated Screw, Short Thread, Headed, Ø5.5 X 85mm Sterile
P20-155-090F-S	Monster® Cannulated Screw, Full Thread, Headed, Ø5.5 X 90mm Sterile
P20-155-090L-S	Monster® Cannulated Screw, Long Thread, Headed, Ø5.5 X 90mm Sterile
P20-155-090S-S	Monster® Cannulated Screw, Short Thread, Headed, Ø5.5 X 90mm Sterile
P20-170-036F-S	Monster® Cannulated Screw, Full Thread, Headed, Ø7.0 x 36mm Sterile
P20-170-036S-S	Monster® Cannulated Screw, Short Thread, Headed, Ø7.0 x 36mm Sterile
P20-170-038F-S	Monster® Cannulated Screw, Full Thread, Headed, Ø7.0 x 38mm Sterile
P20-170-038S-S	Monster® Cannulated Screw, Short Thread, Headed, Ø7.0 x 38mm Sterile
P20-170-040F-S	Monster® Cannulated Screw, Full Thread, Headed, Ø7.0 x 40mm Sterile
P20-170-040M-S	Monster® Cannulated Screw, Medium Thread, Headed, Ø7.0 x 40mm Sterile
P20-170-040S-S	Monster® Cannulated Screw, Short Thread, Headed, Ø7.0 x 40mm Sterile
P20-170-042F-S	Monster® Cannulated Screw, Full Thread, Headed, Ø7.0 x 42mm Sterile
P20-170-042M-S	Monster® Cannulated Screw, Medium Thread, Headed, Ø7.0 x 42mm Sterile
P20-170-042S-S	Monster® Cannulated Screw, Short Thread, Headed, Ø7.0 x 42mm Sterile

Not all products available for sale in all markets. To determine availability in your marketplace, please contact your local Paragon 28 representative or email info@paragon28.com.

STERILE PACKAGED PRODUCT

PART NUMBER	DESCRIPTION
P20-170-044F-S	Monster® Cannulated Screw, Full Thread, Headed, Ø7.0 x 44mm Sterile
P20-170-044L-S	Monster® Cannulated Screw, Long Thread, Headed, Ø7.0 x 44mm Sterile
P20-170-044M-S	Monster® Cannulated Screw, Medium Thread, Headed, Ø7.0 x 44mm Sterile
P20-170-044S-S	Monster® Cannulated Screw, Short Thread, Headed, Ø7.0 x 44mm Sterile
P20-170-046F-S	Monster® Cannulated Screw, Full Thread, Headed, Ø7.0 x 46mm Sterile
P20-170-046L-S	Monster® Cannulated Screw, Long Thread, Headed, Ø7.0 x 46mm Sterile
P20-170-046M-S	Monster® Cannulated Screw, Medium Thread, Headed, Ø7.0 x 46mm Sterile
P20-170-046S-S	Monster® Cannulated Screw, Short Thread, Headed, Ø7.0 x 46mm Sterile
P20-170-048F-S	Monster® Cannulated Screw, Full Thread, Headed, Ø7.0 x 48mm Sterile
P20-170-048L-S	Monster® Cannulated Screw, Long Thread, Headed, Ø7.0 x 48mm Sterile
P20-170-048M-S	Monster® Cannulated Screw, Medium Thread, Headed, Ø7.0 x 48mm Sterile
P20-170-048S-S	Monster® Cannulated Screw, Short Thread, Headed, Ø7.0 x 48mm Sterile
P20-170-050F-S	Monster® Cannulated Screw, Full Thread, Headed, Ø7.0 x 50mm Sterile
P20-170-050L-S	Monster® Cannulated Screw, Long Thread, Headed, Ø7.0 x 50mm Sterile
P20-170-050M-S	Monster® Cannulated Screw, Medium Thread, Headed, Ø7.0 x 50mm Sterile
P20-170-050S-S	Monster® Cannulated Screw, Short Thread, Headed, Ø7.0 x 50mm Sterile
P20-170-055F-S	Monster® Cannulated Screw, Full Thread, Headed, Ø7.0 x 55mm Sterile
P20-170-055L-S	Monster® Cannulated Screw, Long Thread, Headed, Ø7.0 x 55mm Sterile
P20-170-055M-S	Monster® Cannulated Screw, Medium Thread, Headed, Ø7.0 x 55mm Sterile
P20-170-055S-S	Monster® Cannulated Screw, Short Thread, Headed, Ø7.0 x 55mm Sterile
P20-170-060F-S	Monster® Cannulated Screw, Full Thread, Headed, Ø7.0 x 60mm Sterile
P20-170-060L-S	Monster® Cannulated Screw, Long Thread, Headed, Ø7.0 x 60mm Sterile
P20-170-060M-S	Monster® Cannulated Screw, Medium Thread, Headed, Ø7.0 x 60mm Sterile
P20-170-060S-S	Monster® Cannulated Screw, Short Thread, Headed, Ø7.0 x 60mm Sterile
P20-170-065F-S	Monster® Cannulated Screw, Full Thread, Headed, Ø7.0 x 65mm Sterile
P20-170-065L-S	Monster® Cannulated Screw, Long Thread, Headed, Ø7.0 x 65mm Sterile
P20-170-065M-S	Monster® Cannulated Screw, Medium Thread, Headed, Ø7.0 x 65mm Sterile
P20-170-065S-S	Monster® Cannulated Screw, Short Thread, Headed, Ø7.0 x 65mm Sterile
P20-170-070F-S	Monster® Cannulated Screw, Full Thread, Headed, Ø7.0 x 70mm Sterile
P20-170-070L-S	Monster® Cannulated Screw, Long Thread, Headed, Ø7.0 x 70mm Sterile
P20-170-070M-S	Monster® Cannulated Screw, Medium Thread, Headed, Ø7.0 x 70mm Sterile
P20-170-070S-S	Monster® Cannulated Screw, Short Thread, Headed, Ø7.0 x 70mm Sterile
P20-170-072F-S	Monster® Cannulated Screw, Full Thread, Headed, Ø7.0 x 72mm Sterile
P20-170-072L-S	Monster® Cannulated Screw, Long Thread, Headed, Ø7.0 x 72mm Sterile
P20-170-072M-S	Monster® Cannulated Screw, Medium Thread, Headed, Ø7.0 x 72mm Sterile
P20-170-072S-S	Monster® Cannulated Screw, Short Thread, Headed, Ø7.0 x 72mm Sterile
P20-170-074F-S	Monster® Cannulated Screw, Full Thread, Headed, Ø7.0 x 74mm Sterile
P20-170-074L-S	Monster® Cannulated Screw, Long Thread, Headed, Ø7.0 x 74mm Sterile
P20-170-074M-S	Monster® Cannulated Screw, Medium Thread, Headed, Ø7.0 x 74mm Sterile
P20-170-074S-S	Monster® Cannulated Screw, Short Thread, Headed, Ø7.0 x 74mm Sterile

Not all products available for sale in all markets. To determine availability in your marketplace, please contact your local Paragon 28 representative or email info@paragon28.com.

STERILE PACKAGED PRODUCT

PART NUMBER	DESCRIPTION
P20-170-076F-S	Monster® Cannulated Screw, Full Thread, Headed, Ø7.0 x 76mm Sterile
P20-170-076L-S	Monster® Cannulated Screw, Long Thread, Headed, Ø7.0 x 76mm Sterile
P20-170-076M-S	Monster® Cannulated Screw, Medium Thread, Headed, Ø7.0 x 76mm Sterile
P20-170-076S-S	Monster® Cannulated Screw, Short Thread, Headed, Ø7.0 x 76mm Sterile
P20-170-078F-S	Monster® Cannulated Screw, Full Thread, Headed, Ø7.0 x 78mm Sterile
P20-170-078L-S	Monster® Cannulated Screw, Long Thread, Headed, Ø7.0 x 78mm Sterile
P20-170-078M-S	Monster® Cannulated Screw, Medium Thread, Headed, Ø7.0 x 78mm Sterile
P20-170-078S-S	Monster® Cannulated Screw, Short Thread, Headed, Ø7.0 x 78mm Sterile
P20-170-080F-S	Monster® Cannulated Screw, Full Thread, Headed, Ø7.0 x 80mm Sterile
P20-170-080L-S	Monster® Cannulated Screw, Long Thread, Headed, Ø7.0 x 80mm Sterile
P20-170-080M-S	Monster® Cannulated Screw, Medium Thread, Headed, Ø7.0 x 80mm Sterile
P20-170-080S-S	Monster® Cannulated Screw, Short Thread, Headed, Ø7.0 x 80mm Sterile
P20-170-082F-S	Monster® Cannulated Screw, Full Thread, Headed, Ø7.0 x 82mm Sterile
P20-170-082L-S	Monster® Cannulated Screw, Long Thread, Headed, Ø7.0 x 82mm Sterile
P20-170-082M-S	Monster® Cannulated Screw, Medium Thread, Headed, Ø7.0 x 82mm Sterile
P20-170-082S-S	Monster® Cannulated Screw, Short Thread, Headed, Ø7.0 x 82mm Sterile
P20-170-084F-S	Monster® Cannulated Screw, Full Thread, Headed, Ø7.0 x 84mm Sterile
P20-170-084L-S	Monster® Cannulated Screw, Long Thread, Headed, Ø7.0 x 84mm Sterile
P20-170-084M-S	Monster® Cannulated Screw, Medium Thread, Headed, Ø7.0 x 84 mm Sterile
P20-170-084S-S	Monster® Cannulated Screw, Short Thread, Headed, Ø7.0 x 84mm Sterile
P20-170-086F-S	Monster® Cannulated Screw, Full Thread, Headed, Ø7.0 x 86mm Sterile
P20-170-086L-S	Monster® Cannulated Screw, Long Thread, Headed, Ø7.0 x 86mm Sterile
P20-170-086M-S	Monster® Cannulated Screw, Medium Thread, Headed, Ø7.0 x 86 mm Sterile
P20-170-086S-S	Monster® Cannulated Screw, Short Thread, Headed, Ø7.0 x 86mm Sterile
P20-170-088F-S	Monster® Cannulated Screw, Full Thread, Headed, Ø7.0 x 88mm Sterile
P20-170-088L-S	Monster® Cannulated Screw, Long Thread, Headed, Ø7.0 x 88mm Sterile
P20-170-088M-S	Monster® Cannulated Screw, Medium Thread, Headed, Ø7.0 x 88mm Sterile
P20-170-088S-S	Monster® Cannulated Screw, Short Thread, Headed, Ø7.0 x 88mm Sterile
P20-170-090F-S	Monster® Cannulated Screw, Full Thread, Headed, Ø7.0 x 90mm Sterile
P20-170-090L-S	Monster® Cannulated Screw, Long Thread, Headed, Ø7.0 x 90mm Sterile
P20-170-090M-S	Monster® Cannulated Screw, Medium Thread, Headed, Ø7.0 x 90mm Sterile
P20-170-090S-S	Monster® Cannulated Screw, Short Thread, Headed, Ø7.0 x 90mm Sterile
P20-170-095F-S	Monster® Cannulated Screw, Full Thread, Headed, Ø7.0 x 95mm Sterile
P20-170-095L-S	Monster® Cannulated Screw, Long Thread, Headed, Ø7.0 x 95mm Sterile
P20-170-095M-S	Monster® Cannulated Screw, Medium Thread, Headed, Ø7.0 x 95mm Sterile
P20-170-095S-S	Monster® Cannulated Screw, Short Thread, Headed, Ø7.0 x 95mm Sterile
P20-170-100F-S	Monster® Cannulated Screw, Full Thread, Headed, Ø7.0 x 100mm Sterile
P20-170-100L-S	Monster® Cannulated Screw, Long Thread, Headed, Ø7.0 x 100mm Sterile
P20-170-100M-S	Monster® Cannulated Screw, Medium Thread, Headed, Ø7.0 x 100mm Sterile
P20-170-100S-S	Monster® Cannulated Screw, Short Thread, Headed, Ø7.0 x 100mm Sterile

Not all products available for sale in all markets. To determine availability in your marketplace, please contact your local Paragon 28 representative or email info@paragon28.com.

STERILE PACKAGED PRODUCT

PART NUMBER	DESCRIPTION
P20-170-105F-S	Monster® Cannulated Screw, Full Thread, Headed, Ø7.0 x 105mm Sterile
P20-170-105L-S	Monster® Cannulated Screw, Long Thread, Headed, Ø7.0 x 105mm Sterile
P20-170-105M-S	Monster® Cannulated Screw, Medium Thread, Headed, Ø7.0 x 105mm Sterile
P20-170-105S-S	Monster® Cannulated Screw, Short Thread, Headed, Ø7.0 x 105mm Sterile
P20-170-110F-S	Monster® Cannulated Screw, Full Thread, Headed, Ø7.0 x 110mm Sterile
P20-170-110L-S	Monster® Cannulated Screw, Long Thread, Headed, Ø7.0 x 110mm Sterile
P20-170-110M-S	Monster® Cannulated Screw, Medium Thread, Headed, Ø7.0 x 110mm Sterile
P20-170-110S-S	Monster® Cannulated Screw, Short Thread, Headed, Ø7.0 x 110mm Sterile
P20-170-115F-S	Monster® Cannulated Screw, Full Thread, Headed, Ø7.0 x 115mm Sterile
P20-170-115L-S	Monster® Cannulated Screw, Long Thread, Headed, Ø7.0 x 115mm Sterile
P20-170-115M-S	Monster® Cannulated Screw, Medium Thread, Headed, Ø7.0 x 115mm Sterile
P20-170-115S-S	Monster® Cannulated Screw, Short Thread, Headed, Ø7.0 x 115mm Sterile
P20-170-120F-S	Monster® Cannulated Screw, Full Thread, Headed, Ø7.0 x 120mm Sterile
P20-170-120L-S	Monster® Cannulated Screw, Long Thread, Headed, Ø7.0 x 120mm Sterile
P20-170-120M-S	Monster® Cannulated Screw, Medium Thread, Headed, Ø7.0 x 120mm Sterile
P20-170-120S-S	Monster® Cannulated Screw, Short Thread, Headed, Ø7.0 x 120mm Sterile
P20-170-125F-S	Monster® Cannulated Screw, Full Thread, Headed, Ø7.0 x 125mm Sterile
P20-170-125L-S	Monster® Cannulated Screw, Long Thread, Headed, Ø7.0 x 125mm Sterile
P20-170-125M-S	Monster® Cannulated Screw, Medium Thread, Headed, Ø7.0 x 125mm Sterile
P20-170-125S-S	Monster® Cannulated Screw, Short Thread, Headed, Ø7.0 x 125mm Sterile
P20-170-130F-S	Monster® Cannulated Screw, Full Thread, Headed, Ø7.0 x 130mm Sterile
P20-170-130L-S	Monster® Cannulated Screw, Long Thread, Headed, Ø7.0 x 130mm Sterile
P20-170-130M-S	Monster® Cannulated Screw, Medium Thread, Headed, Ø7.0 x 130mm Sterile
P20-170-130S-S	Monster® Cannulated Screw, Short Thread, Headed, Ø7.0 x 130mm Sterile
P20-520-010S-S	Mini-Monster® Cannulated Screw, Short Thread, Headless, Ø2.0 x 10mm Sterile
P20-520-011S-S	Mini-Monster® Cannulated Screw, Short Thread, Headless, Ø2.0 x 11mm Sterile
P20-520-012S-S	Mini-Monster® Cannulated Screw, Short Thread, Headless, Ø2.0 x 12mm Sterile
P20-520-013S-S	Mini-Monster® Cannulated Screw, Short Thread, Headless, Ø2.0 x 13mm Sterile
P20-520-014S-S	Mini-Monster® Cannulated Screw, Short Thread, Headless, Ø2.0 x 14mm Sterile
P20-520-015S-S	Mini-Monster® Cannulated Screw, Short Thread, Headless, Ø2.0 x 15mm Sterile
P20-520-016S-S	Mini-Monster® Cannulated Screw, Short Thread, Headless, Ø2.0 x 16mm Sterile
P20-520-017S-S	Mini-Monster® Cannulated Screw, Short Thread, Headless, Ø2.0 x 17mm Sterile
P20-520-018S-S	Mini-Monster® Cannulated Screw, Short Thread, Headless, Ø2.0 x 18mm Sterile
P20-520-019S-S	Mini-Monster® Cannulated Screw, Short Thread, Headless, Ø2.0 x 19mm Sterile
P20-520-020S-S	Mini-Monster® Cannulated Screw, Short Thread, Headless, Ø2.0 x 20mm Sterile
P20-520-022S-S	Mini-Monster® Cannulated Screw, Short Thread, Headless, Ø2.0 x 22mm Sterile
P20-520-024S-S	Mini-Monster® Cannulated Screw, Short Thread, Headless, Ø2.0 x 24mm Sterile
P20-520-026S-S	Mini-Monster® Cannulated Screw, Short Thread, Headless, Ø2.0 x 26mm Sterile
P20-520-028S-S	Mini-Monster® Cannulated Screw, Short Thread, Headless, Ø2.0 x 28mm Sterile
P20-520-030L-S	Mini-Monster® Cannulated Screw, Long Thread, Headless, Ø2.0 x 30mm Sterile

Not all products available for sale in all markets. To determine availability in your marketplace, please contact your local Paragon 28 representative or email info@paragon28.com.

STERILE PACKAGED PRODUCT

PART NUMBER	DESCRIPTION
P20-520-030S-S	Mini-Monster® Cannulated Screw, Short Thread, Headless, Ø2.0 x 30mm Sterile
P20-520-032L-S	Mini-Monster® Cannulated Screw, Long Thread, Headless, Ø2.0 x 32mm Sterile
P20-520-032S-S	Mini-Monster® Cannulated Screw, Short Thread, Headless, Ø2.0 x 32mm Sterile
P20-520-034L-S	Mini-Monster® Cannulated Screw, Long Thread, Headless, Ø2.0 x 34mm Sterile
P20-520-034S-S	Mini-Monster® Cannulated Screw, Short Thread, Headless, Ø2.0 x 34mm Sterile
P20-520-036L-S	Mini-Monster® Cannulated Screw, Long Thread, Headless, Ø2.0 x 36mm Sterile
P20-520-036S-S	Mini-Monster® Cannulated Screw, Short Thread, Headless, Ø2.0 x 36mm Sterile
P20-520-038L-S	Mini-Monster® Cannulated Screw, Long Thread, Headless, Ø2.0 x 38mm Sterile
P20-520-038S-S	Mini-Monster® Cannulated Screw, Short Thread, Headless, Ø2.0 x 38mm Sterile
P20-520-040L-S	Mini-Monster® Cannulated Screw, Long Thread, Headless, Ø2.0 x 40mm Sterile
P20-520-040S-S	Mini-Monster® Cannulated Screw, Short Thread, Headless, Ø2.0 x 40mm Sterile
P20-520-042L-S	Mini-Monster® Cannulated Screw, Long Thread, Headless, Ø2.0 x 42mm Sterile
P20-520-042S-S	Mini-Monster® Cannulated Screw, Short Thread, Headless, Ø2.0 x 42mm Sterile
P20-520-044L-S	Mini-Monster® Cannulated Screw, Long Thread, Headless, Ø2.0 x 44mm Sterile
P20-520-044S-S	Mini-Monster® Cannulated Screw, Short Thread, Headless, Ø2.0 x 44mm Sterile
P20-520-046L-S	Mini-Monster® Cannulated Screw, Long Thread, Headless, Ø2.0 x 46mm Sterile
P20-520-046S-S	Mini-Monster® Cannulated Screw, Short Thread, Headless, Ø2.0 x 46mm Sterile
P20-520-048L-S	Mini-Monster® Cannulated Screw, Long Thread, Headless, Ø2.0 x 48mm Sterile
P20-520-048S-S	Mini-Monster® Cannulated Screw, Short Thread, Headless, Ø2.0 x 48mm Sterile
P20-520-050L-S	Mini-Monster® Cannulated Screw, Long Thread, Headless, Ø2.0 x 50mm Sterile
P20-520-050S-S	Mini-Monster® Cannulated Screw, Short Thread, Headless, Ø2.0 x 50mm Sterile
P20-525-010S-S	Mini-Monster® Cannulated Screw, Short Thread, Headless, Ø2.5 x 10 mm Sterile
P20-525-011S-S	Mini-Monster® Cannulated Screw, Short Thread, Headless, Ø2.5 x 11 mm Sterile
P20-525-012S-S	Mini-Monster® Cannulated Screw, Short Thread, Headless, Ø2.5 x 12 mm Sterile
P20-525-013S-S	Mini-Monster® Cannulated Screw, Short Thread, Headless, Ø2.5 x 13 mm Sterile
P20-525-014S-S	Mini-Monster® Cannulated Screw, Short Thread, Headless, Ø2.5 x 14 mm Sterile
P20-525-015S-S	Mini-Monster® Cannulated Screw, Short Thread, Headless, Ø2.5 x 15 mm Sterile
P20-525-016S-S	Mini-Monster® Cannulated Screw, Short Thread, Headless, Ø2.5 x 16 mm Sterile
P20-525-017S-S	Mini-Monster® Cannulated Screw, Short Thread, Headless, Ø2.5 x 17 mm Sterile
P20-525-018S-S	Mini-Monster® Cannulated Screw, Short Thread, Headless, Ø2.5 x 18 mm Sterile
P20-525-019S-S	Mini-Monster® Cannulated Screw, Short Thread, Headless, Ø2.5 x 19 mm Sterile
P20-525-020S-S	Mini-Monster® Cannulated Screw, Short Thread, Headless, Ø2.5 x 20 mm Sterile
P20-525-022S-S	Mini-Monster® Cannulated Screw, Short Thread, Headless, Ø2.5 x 22 mm Sterile
P20-525-024S-S	Mini-Monster® Cannulated Screw, Short Thread, Headless, Ø2.5 x 24 mm Sterile
P20-525-026S-S	Mini-Monster® Cannulated Screw, Short Thread, Headless, Ø2.5 x 26 mm Sterile
P20-525-028S-S	Mini-Monster® Cannulated Screw, Short Thread, Headless, Ø2.5 x 28 mm Sterile
P20-525-030L-S	Mini-Monster® Cannulated Screw, Long Thread, Headless, Ø2.5 x 30 mm Sterile
P20-525-030S-S	Mini-Monster® Cannulated Screw, Short Thread, Headless, Ø2.5 x 30 mm Sterile
P20-525-032L-S	Mini-Monster® Cannulated Screw, Long Thread, Headless, Ø2.5 x 32 mm Sterile
P20-525-032S-S	Mini-Monster® Cannulated Screw, Short Thread, Headless, Ø2.5 x 32 mm Sterile

Not all products available for sale in all markets. To determine availability in your marketplace, please contact your local Paragon 28 representative or email info@paragon28.com.

STERILE PACKAGED PRODUCT

PART NUMBER	DESCRIPTION
P20-525-034L-S	Mini-Monster® Cannulated Screw, Long Thread, Headless, Ø2.5 x 34 mm Sterile
P20-525-034S-S	Mini-Monster® Cannulated Screw, Short Thread, Headless, Ø2.5 x 34 mm Sterile
P20-525-036L-S	Mini-Monster® Cannulated Screw, Long Thread, Headless, Ø2.5 x 36 mm Sterile
P20-525-036S-S	Mini-Monster® Cannulated Screw, Short Thread, Headless, Ø2.5 x 36 mm Sterile
P20-525-038L-S	Mini-Monster® Cannulated Screw, Long Thread, Headless, Ø2.5 x 38 mm Sterile
P20-525-038S-S	Mini-Monster® Cannulated Screw, Short Thread, Headless, Ø2.5 x 38 mm Sterile
P20-525-040L-S	Mini-Monster® Cannulated Screw, Long Thread, Headless, Ø2.5 x 40 mm Sterile
P20-525-040S-S	Mini-Monster® Cannulated Screw, Short Thread, Headless, Ø2.5 x 40 mm Sterile
P20-525-042L-S	Mini-Monster® Cannulated Screw, Long Thread, Headless, Ø2.5 x 42 mm Sterile
P20-525-042S-S	Mini-Monster® Cannulated Screw, Short Thread, Headless, Ø2.5 x 42 mm Sterile
P20-525-044L-S	Mini-Monster® Cannulated Screw, Long Thread, Headless, Ø2.5 x 44 mm Sterile
P20-525-044S-S	Mini-Monster® Cannulated Screw, Short Thread, Headless, Ø2.5 x 44 mm Sterile
P20-525-046L-S	Mini-Monster® Cannulated Screw, Long Thread, Headless, Ø2.5 x 46 mm Sterile
P20-525-046S-S	Mini-Monster® Cannulated Screw, Short Thread, Headless, Ø2.5 x 46 mm Sterile
P20-525-048L-S	Mini-Monster® Cannulated Screw, Long Thread, Headless, Ø2.5 x 48 mm Sterile
P20-525-048S-S	Mini-Monster® Cannulated Screw, Short Thread, Headless, Ø2.5 x 48 mm Sterile
P20-525-050L-S	Mini-Monster® Cannulated Screw, Long Thread, Headless, Ø2.5 x 50 mm Sterile
P20-525-050S-S	Mini-Monster® Cannulated Screw, Short Thread, Headless, Ø2.5 x 50 mm Sterile
P20-530-010S-S	Mini-Monster® Cannulated Screw, Short Thread, Headless Ø3.0 x 10mm Sterile
P20-530-012S-S	Mini-Monster® Cannulated Screw, Short Thread, Headless Ø3.0 x 12mm Sterile
P20-530-014S-S	Mini-Monster® Cannulated Screw, Short Thread, Headless Ø3.0 x 14mm Sterile
P20-530-016S-S	Mini-Monster® Cannulated Screw, Short Thread, Headless Ø3.0 x 16mm Sterile
P20-530-018S-S	Mini-Monster® Cannulated Screw, Short Thread, Headless Ø3.0 x 18mm Sterile
P20-530-020S-S	Mini-Monster® Cannulated Screw, Short Thread, Headless Ø3.0 x 20mm Sterile
P20-530-022S-S	Mini-Monster® Cannulated Screw, Short Thread, Headless Ø3.0 x 22mm Sterile
P20-530-024S-S	Mini-Monster® Cannulated Screw, Short Thread, Headless Ø3.0 x 24mm Sterile
P20-530-026S-S	Mini-Monster® Cannulated Screw, Short Thread, Headless Ø3.0 x 26mm Sterile
P20-530-028S-S	Mini-Monster® Cannulated Screw, Short Thread, Headless Ø3.0 x 28mm Sterile
P20-530-030S-S	Mini-Monster® Cannulated Screw, Short Thread, Headless Ø3.0 x 30mm Sterile
P20-530-032S-S	Mini-Monster® Cannulated Screw, Short Thread, Headless Ø3.0 x 32mm Sterile
P20-530-034S-S	Mini-Monster® Cannulated Screw, Short Thread, Headless Ø3.0 x 34mm Sterile
P20-530-036S-S	Mini-Monster® Cannulated Screw, Short Thread, Headless Ø3.0 x 36mm Sterile
P20-530-038S-S	Mini-Monster® Cannulated Screw, Short Thread, Headless Ø3.0 x 38mm Sterile
P20-530-040S-S	Mini-Monster® Cannulated Screw, Short Thread, Headless Ø3.0 x 40mm Sterile
P20-530-042S-S	Mini-Monster® Cannulated Screw, Short Thread, Headless Ø3.0 x 42mm Sterile
P20-530-044S-S	Mini-Monster® Cannulated Screw, Short Thread, Headless Ø3.0 x 44mm Sterile
P20-530-046S-S	Mini-Monster® Cannulated Screw, Short Thread, Headless Ø3.0 x 46mm Sterile
P20-530-048S-S	Mini-Monster® Cannulated Screw, Short Thread, Headless Ø3.0 x 48mm Sterile
P20-530-050S-S	Mini-Monster® Cannulated Screw, Short Thread, Headless Ø3.0 x 50mm Sterile
P20-535-012S-S	Mini-Monster® Cannulated Screw, Short Thread, Headless, Ø3.5 x 12 mm Sterile

Not all products available for sale in all markets. To determine availability in your marketplace, please contact your local Paragon 28 representative or email info@paragon28.com.

STERILE PACKAGED PRODUCT

PART NUMBER	DESCRIPTION
P20-535-014S-S	Mini-Monster® Cannulated Screw, Short Thread, Headless, Ø3.5 x 14 mm Sterile
P20-535-016S-S	Mini-Monster® Cannulated Screw, Short Thread, Headless, Ø3.5 x 16 mm Sterile
P20-535-018S-S	Mini-Monster® Cannulated Screw, Short Thread, Headless, Ø3.5 x 18 mm Sterile
P20-535-020S-S	Mini-Monster® Cannulated Screw, Short Thread, Headless, Ø3.5 x 20 mm Sterile
P20-535-022S-S	Mini-Monster® Cannulated Screw, Short Thread, Headless, Ø3.5 x 22 mm Sterile
P20-535-024S-S	Mini-Monster® Cannulated Screw, Short Thread, Headless, Ø3.5 x 24 mm Sterile
P20-535-026S-S	Mini-Monster® Cannulated Screw, Short Thread, Headless, Ø3.5 x 26 mm Sterile
P20-535-028S-S	Mini-Monster® Cannulated Screw, Short Thread, Headless, Ø3.5 x 28 mm Sterile
P20-535-030S-S	Mini-Monster® Cannulated Screw, Short Thread, Headless, Ø3.5 x 30 mm Sterile
P20-535-032S-S	Mini-Monster® Cannulated Screw, Short Thread, Headless, Ø3.5 x 32 mm Sterile
P20-535-034S-S	Mini-Monster® Cannulated Screw, Short Thread, Headless, Ø3.5 x 34 mm Sterile
P20-535-036S-S	Mini-Monster® Cannulated Screw, Short Thread, Headless, Ø3.5 x 36 mm Sterile
P20-535-038S-S	Mini-Monster® Cannulated Screw, Short Thread, Headless, Ø3.5 x 38 mm Sterile
P20-535-040S-S	Mini-Monster® Cannulated Screw, Short Thread, Headless, Ø3.5 x 40 mm Sterile
P20-535-042S-S	Mini-Monster® Cannulated Screw, Short Thread, Headless, Ø3.5 x 42 mm Sterile
P20-535-044S-S	Mini-Monster® Cannulated Screw, Short Thread, Headless, Ø3.5 x 44 mm Sterile
P20-535-046S-S	Mini-Monster® Cannulated Screw, Short Thread, Headless, Ø3.5 x 46 mm Sterile
P20-535-048S-S	Mini-Monster® Cannulated Screw, Short Thread, Headless, Ø3.5 x 48 mm Sterile
P20-535-050S-S	Mini-Monster® Cannulated Screw, Short Thread, Headless, Ø3.5 x 50 mm Sterile
P20-540-014S-S	Mini-Monster® Cannulated Screw, Short Thread, Headless, Ø4.0 x 14 mm Sterile
P20-540-016S-S	Mini-Monster® Cannulated Screw, Short Thread, Headless, Ø4.0 x 16 mm Sterile
P20-540-018S-S	Mini-Monster® Cannulated Screw, Short Thread, Headless, Ø4.0 x 18 mm Sterile
P20-540-020S-S	Mini-Monster® Cannulated Screw, Short Thread, Headless, Ø4.0 x 20 mm Sterile
P20-540-022S-S	Mini-Monster® Cannulated Screw, Short Thread, Headless, Ø4.0 x 22 mm Sterile
P20-540-024S-S	Mini-Monster® Cannulated Screw, Short Thread, Headless, Ø4.0 x 24 mm Sterile
P20-540-026S-S	Mini-Monster® Cannulated Screw, Short Thread, Headless, Ø4.0 x 26 mm Sterile
P20-540-028L-S	Mini-Monster® Cannulated Screw, Long Thread, Headless, Ø4.0 x 28 mm Sterile
P20-540-028S-S	Mini-Monster® Cannulated Screw, Short Thread, Headless, Ø4.0 x 28 mm Sterile
P20-540-030L-S	Mini-Monster® Cannulated Screw, Long Thread, Headless, Ø4.0 x 30 mm Sterile
P20-540-030S-S	Mini-Monster® Cannulated Screw, Short Thread, Headless, Ø4.0 x 30 mm Sterile
P20-540-032L-S	Mini-Monster® Cannulated Screw, Long Thread, Headless, Ø4.0 x 32 mm Sterile
P20-540-032S-S	Mini-Monster® Cannulated Screw, Short Thread, Headless, Ø4.0 x 32 mm Sterile
P20-540-034L-S	Mini-Monster® Cannulated Screw, Long Thread, Headless, Ø4.0 x 34 mm Sterile
P20-540-034S-S	Mini-Monster® Cannulated Screw, Short Thread, Headless, Ø4.0 x 34 mm Sterile
P20-540-036L-S	Mini-Monster® Cannulated Screw, Long Thread, Headless, Ø4.0 x 36 mm Sterile
P20-540-036S-S	Mini-Monster® Cannulated Screw, Short Thread, Headless, Ø4.0 x 36 mm Sterile
P20-540-038L-S	Mini-Monster® Cannulated Screw, Long Thread, Headless, Ø4.0 x 38 mm Sterile
P20-540-038S-S	Mini-Monster® Cannulated Screw, Short Thread, Headless, Ø4.0 x 38 mm Sterile
P20-540-040L-S	Mini-Monster® Cannulated Screw, Long Thread, Headless, Ø4.0 x 40 mm Sterile
P20-540-040S-S	Mini-Monster® Cannulated Screw, Short Thread, Headless, Ø4.0 x 40 mm Sterile

Not all products available for sale in all markets. To determine availability in your marketplace, please contact your local Paragon 28 representative or email info@paragon28.com.

STERILE PACKAGED PRODUCT

PART NUMBER	DESCRIPTION
P20-540-042L-S	Mini-Monster® Cannulated Screw, Long Thread, Headless, Ø4.0 x 42 mm Sterile
P20-540-042S-S	Mini-Monster® Cannulated Screw, Short Thread, Headless, Ø4.0 x 42 mm Sterile
P20-540-044L-S	Mini-Monster® Cannulated Screw, Long Thread, Headless, Ø4.0 x 44 mm Sterile
P20-540-044S-S	Mini-Monster® Cannulated Screw, Short Thread, Headless, Ø4.0 x 44 mm Sterile
P20-540-046L-S	Mini-Monster® Cannulated Screw, Long Thread, Headless, Ø4.0 x 46 mm Sterile
P20-540-046S-S	Mini-Monster® Cannulated Screw, Short Thread, Headless, Ø4.0 x 46 mm Sterile
P20-540-048L-S	Mini-Monster® Cannulated Screw, Long Thread, Headless, Ø4.0 x 48 mm Sterile
P20-540-048S-S	Mini-Monster® Cannulated Screw, Short Thread, Headless, Ø4.0 x 48 mm Sterile
P20-540-050L-S	Mini-Monster® Cannulated Screw, Long Thread, Headless, Ø4.0 x 50 mm Sterile
P20-540-050S-S	Mini-Monster® Cannulated Screw, Short Thread, Headless, Ø4.0 x 50 mm Sterile
P20-540-055L-S	Mini-Monster® Cannulated Screw, Long Thread, Headless, Ø4.0 x 55 mm Sterile
P20-540-055S-S	Mini-Monster® Cannulated Screw, Short Thread, Headless, Ø4.0 x 55 mm Sterile
P20-540-060L-S	Mini-Monster® Cannulated Screw, Long Thread, Headless, Ø4.0 x 60 mm Sterile
P20-540-060S-S	Mini-Monster® Cannulated Screw, Short Thread, Headless, Ø4.0 x 60 mm Sterile
P20-545-018S-S	Monster® Cannulated Screw, Short Thread, Headless, Ø4.5 x 18 mm Sterile
P20-545-020S-S	Monster® Cannulated Screw, Short Thread, Headless, Ø4.5 x 20 mm Sterile
P20-545-022S-S	Monster® Cannulated Screw, Short Thread, Headless, Ø4.5 x 22 mm Sterile
P20-545-024S-S	Monster® Cannulated Screw, Short Thread, Headless, Ø4.5 x 24 mm Sterile
P20-545-026S-S	Monster® Cannulated Screw, Short Thread, Headless, Ø4.5 x 26 mm Sterile
P20-545-028S-S	Monster® Cannulated Screw, Short Thread, Headless, Ø4.5 x 28 mm Sterile
P20-545-030L-S	Monster® Cannulated Screw, Long Thread, Headless, Ø4.5 x 30 mm Sterile
P20-545-030S-S	Monster® Cannulated Screw, Short Thread, Headless, Ø4.5 x 30 mm Sterile
P20-545-032L-S	Monster® Cannulated Screw, Long Thread, Headless, Ø4.5 x 32 mm Sterile
P20-545-032S-S	Monster® Cannulated Screw, Short Thread, Headless, Ø4.5 x 32 mm Sterile
P20-545-034L-S	Monster® Cannulated Screw, Long Thread, Headless, Ø4.5 x 34 mm Sterile
P20-545-034S-S	Monster® Cannulated Screw, Short Thread, Headless, Ø4.5 x 34 mm Sterile
P20-545-036L-S	Monster® Cannulated Screw, Long Thread, Headless, Ø4.5 x 36 mm Sterile
P20-545-036S-S	Monster® Cannulated Screw, Short Thread, Headless, Ø4.5 x 36 mm Sterile
P20-545-038L-S	Monster® Cannulated Screw, Long Thread, Headless, Ø4.5 x 38 mm Sterile
P20-545-038S-S	Monster® Cannulated Screw, Short Thread, Headless, Ø4.5 x 38 mm Sterile
P20-545-040L-S	Monster® Cannulated Screw, Long Thread, Headless, Ø4.5 x 40 mm Sterile
P20-545-040S-S	Monster® Cannulated Screw, Short Thread, Headless, Ø4.5 x 40 mm Sterile
P20-545-042L-S	Monster® Cannulated Screw, Long Thread, Headless, Ø4.5 x 42 mm Sterile
P20-545-042S-S	Monster® Cannulated Screw, Short Thread, Headless, Ø4.5 x 42 mm Sterile
P20-545-044L-S	Monster® Cannulated Screw, Long Thread, Headless, Ø4.5 x 44 mm Sterile
P20-545-044S-S	Monster® Cannulated Screw, Short Thread, Headless, Ø4.5 x 44 mm Sterile
P20-545-046L-S	Monster® Cannulated Screw, Long Thread, Headless, Ø4.5 x 46 mm Sterile
P20-545-046S-S	Monster® Cannulated Screw, Short Thread, Headless, Ø4.5 x 46 mm Sterile
P20-545-048L-S	Monster® Cannulated Screw, Long Thread, Headless, Ø4.5 x 48 mm Sterile
P20-545-048S-S	Monster® Cannulated Screw, Short Thread, Headless, Ø4.5 x 48 mm Sterile

Not all products available for sale in all markets. To determine availability in your marketplace, please contact your local Paragon 28 representative or email info@paragon28.com.

STERILE PACKAGED PRODUCT

PART NUMBER	DESCRIPTION
P20-545-050L-S	Monster® Cannulated Screw, Long Thread, Headless, Ø4.5 x 50 mm Sterile
P20-545-050S-S	Monster® Cannulated Screw, Short Thread, Headless, Ø4.5 x 50 mm Sterile
P20-545-055L-S	Monster® Cannulated Screw, Long Thread, Headless, Ø4.5 x 55 mm Sterile
P20-545-055S-S	Monster® Cannulated Screw, Short Thread, Headless, Ø4.5 x 55 mm Sterile
P20-545-060L-S	Monster® Cannulated Screw, Long Thread, Headless, Ø4.5 x 60 mm Sterile
P20-545-060S-S	Monster® Cannulated Screw, Short Thread, Headless, Ø4.5 x 60 mm Sterile
P20-545-065L-S	Monster® Cannulated Screw, Long Thread, Headless, Ø4.5 x 65 mm Sterile
P20-545-065S-S	Monster® Cannulated Screw, Short Thread, Headless, Ø4.5 x 65 mm Sterile
P20-545-070L-S	Monster® Cannulated Screw, Long Thread, Headless, Ø4.5 x 70 mm Sterile
P20-545-070S-S	Monster® Cannulated Screw, Short Thread, Headless, Ø4.5 x 70 mm Sterile
P20-555-026S-S	Monster® Cannulated Screw, Short Thread, Headless, Ø5.5 X 26mm Sterile
P20-555-028S-S	Monster® Cannulated Screw, Short Thread, Headless, Ø5.5 X 28mm Sterile
P20-555-030S-S	Monster® Cannulated Screw, Short Thread, Headless, Ø5.5 X 30mm Sterile
P20-555-032S-S	Monster® Cannulated Screw, Short Thread, Headless, Ø5.5 X 32mm Sterile
P20-555-034S-S	Monster® Cannulated Screw, Short Thread, Headless, Ø5.5 X 34mm Sterile
P20-555-036S-S	Monster® Cannulated Screw, Short Thread, Headless, Ø5.5 X 36mm Sterile
P20-555-038S-S	Monster® Cannulated Screw, Short Thread, Headless, Ø5.5 X 38mm Sterile
P20-555-040L-S	Monster® Cannulated Screw, Long Thread, Headless, Ø5.5 X 40mm Sterile
P20-555-040S-S	Monster® Cannulated Screw, Short Thread, Headless, Ø5.5 X 40mm Sterile
P20-555-042L-S	Monster® Cannulated Screw, Long Thread, Headless, Ø5.5 X 42mm Sterile
P20-555-042S-S	Monster® Cannulated Screw, Short Thread, Headless, Ø5.5 X 42mm Sterile
P20-555-044L-S	Monster® Cannulated Screw, Long Thread, Headless, Ø5.5 X 44mm Sterile
P20-555-044S-S	Monster® Cannulated Screw, Short Thread, Headless, Ø5.5 X 44mm Sterile
P20-555-046L-S	Monster® Cannulated Screw, Long Thread, Headless, Ø5.5 X 46mm Sterile
P20-555-046S-S	Monster® Cannulated Screw, Short Thread, Headless, Ø5.5 X 46mm Sterile
P20-555-048L-S	Monster® Cannulated Screw, Long Thread, Headless, Ø5.5 X 48mm Sterile
P20-555-048S-S	Monster® Cannulated Screw, Short Thread, Headless, Ø5.5 X 48mm Sterile
P20-555-050L-S	Monster® Cannulated Screw, Long Thread, Headless, Ø5.5 X 50mm Sterile
P20-555-050S-S	Monster® Cannulated Screw, Short Thread, Headless, Ø5.5 X 50mm Sterile
P20-555-052L-S	Monster® Cannulated Screw, Long Thread, Headless, Ø5.5 X 52mm Sterile
P20-555-052S-S	Monster® Cannulated Screw, Short Thread, Headless, Ø5.5 X 52mm Sterile
P20-555-054L-S	Monster® Cannulated Screw, Long Thread, Headless, Ø5.5 X 54mm Sterile
P20-555-054S-S	Monster® Cannulated Screw, Short Thread, Headless, Ø5.5 X 54mm Sterile
P20-555-056L-S	Monster® Cannulated Screw, Long Thread, Headless, Ø5.5 X 56mm Sterile
P20-555-056S-S	Monster® Cannulated Screw, Short Thread, Headless, Ø5.5 X 56mm Sterile
P20-555-058L-S	Monster® Cannulated Screw, Long Thread, Headless, Ø5.5 X 58mm Sterile
P20-555-058S-S	Monster® Cannulated Screw, Short Thread, Headless, Ø5.5 X 58mm Sterile
P20-555-060L-S	Monster® Cannulated Screw, Long Thread, Headless, Ø5.5 X 60mm Sterile
P20-555-060S-S	Monster® Cannulated Screw, Short Thread, Headless, Ø5.5 X 60mm Sterile
P20-555-065L-S	Monster® Cannulated Screw, Long Thread, Headless, Ø5.5 X 65mm Sterile

Not all products available for sale in all markets. To determine availability in your marketplace, please contact your local Paragon 28 representative or email info@paragon28.com.

STERILE PACKAGED PRODUCT

PART NUMBER	DESCRIPTION
P20-555-065S-S	Monster® Cannulated Screw, Short Thread, Headless, Ø5.5 X 65mm Sterile
P20-555-070L-S	Monster® Cannulated Screw, Long Thread, Headless, Ø5.5 X 70mm Sterile
P20-555-070S-S	Monster® Cannulated Screw, Short Thread, Headless, Ø5.5 X 70mm Sterile
P20-555-075L-S	Monster® Cannulated Screw, Long Thread, Headless, Ø5.5 X 75mm Sterile
P20-555-075S-S	Monster® Cannulated Screw, Short Thread, Headless, Ø5.5 X 75mm Sterile
P20-555-080L-S	Monster® Cannulated Screw, Long Thread, Headless, Ø5.5 X 80mm Sterile
P20-555-080S-S	Monster® Cannulated Screw, Short Thread, Headless, Ø5.5 X 80mm Sterile
P20-555-085L-S	Monster® Cannulated Screw, Long Thread, Headless, Ø5.5 X 85mm Sterile
P20-555-085S-S	Monster® Cannulated Screw, Short Thread, Headless, Ø5.5 X 85mm Sterile
P20-555-090L-S	Monster® Cannulated Screw, Long Thread, Headless, Ø5.5 X 90mm Sterile
P20-555-090S-S	Monster® Cannulated Screw, Short Thread, Headless, Ø5.5 X 90mm Sterile
P20-570-036S-S	Monster® Cannulated Screw, Short Thread, Headless, Ø7.0 x 36mm Sterile
P20-570-038S-S	Monster® Cannulated Screw, Short Thread, Headless, Ø7.0 x 38mm Sterile
P20-570-040S-S	Monster® Cannulated Screw, Short Thread, Headless, Ø7.0 x 40mm Sterile
P20-570-042S-S	Monster® Cannulated Screw, Short Thread, Headless, Ø7.0 x 42mm Sterile
P20-570-044M-S	Monster® Cannulated Screw, Medium Thread, Headless, Ø7.0 x 44mm Sterile
P20-570-044S-S	Monster® Cannulated Screw, Short Thread, Headless, Ø7.0 x 44mm Sterile
P20-570-046M-S	Monster® Cannulated Screw, Medium Thread, Headless, Ø7.0 x 46mm Sterile
P20-570-046S-S	Monster® Cannulated Screw, Short Thread, Headless, Ø7.0 x 46mm Sterile
P20-570-048M-S	Monster® Cannulated Screw, Medium Thread, Headless, Ø7.0 x 48mm Sterile
P20-570-048S-S	Monster® Cannulated Screw, Short Thread, Headless, Ø7.0 x 48mm Sterile
P20-570-050M-S	Monster® Cannulated Screw, Medium Thread, Headless, Ø7.0 x 50mm Sterile
P20-570-050S-S	Monster® Cannulated Screw, Short Thread, Headless, Ø7.0 x 50mm Sterile
P20-570-055M-S	Monster® Cannulated Screw, Medium Thread, Headless, Ø7.0 x 55mm Sterile
P20-570-055S-S	Monster® Cannulated Screw, Short Thread, Headless, Ø7.0 x 55mm Sterile
P20-570-060L-S	Monster® Cannulated Screw, Long Thread, Headless, Ø7.0 x 60mm Sterile
P20-570-060M-S	Monster® Cannulated Screw, Medium Thread, Headless, Ø7.0 x 60mm Sterile
P20-570-060S-S	Monster® Cannulated Screw, Short Thread, Headless, Ø7.0 x 60mm Sterile
P20-570-065L-S	Monster® Cannulated Screw, Long Thread, Headless, Ø7.0 x 65mm Sterile
P20-570-065M-S	Monster® Cannulated Screw, Medium Thread, Headless, Ø7.0 x 65mm Sterile
P20-570-065S-S	Monster® Cannulated Screw, Short Thread, Headless, Ø7.0 x 65mm Sterile
P20-570-070L-S	Monster® Cannulated Screw, Long Thread, Headless, Ø7.0 x 70mm Sterile
P20-570-070M-S	Monster® Cannulated Screw, Medium Thread, Headless, Ø7.0 x 70mm Sterile
P20-570-070S-S	Monster® Cannulated Screw, Short Thread, Headless, Ø7.0 x 70mm Sterile
P20-570-072L-S	Monster® Cannulated Screw, Long Thread, Headless, Ø7.0 x 72mm Sterile
P20-570-072M-S	Monster® Cannulated Screw, Medium Thread, Headless, Ø7.0 x 72mm Sterile
P20-570-072S-S	Monster® Cannulated Screw, Short Thread, Headless, Ø7.0 x 72mm Sterile
P20-570-074L-S	Monster® Cannulated Screw, Long Thread, Headless, Ø7.0 x 74mm Sterile
P20-570-074M-S	Monster® Cannulated Screw, Medium Thread, Headless, Ø7.0 x 74mm Sterile
P20-570-074S-S	Monster® Cannulated Screw, Short Thread, Headless, Ø7.0 x 74mm Sterile

Not all products available for sale in all markets. To determine availability in your marketplace, please contact your local Paragon 28 representative or email info@paragon28.com.

STERILE PACKAGED PRODUCT

PART NUMBER	DESCRIPTION
P20-570-076L-S	Monster® Cannulated Screw, Long Thread, Headless, Ø7.0 x 76mm Sterile
P20-570-076M-S	Monster® Cannulated Screw, Medium Thread, Headless, Ø7.0 x 76mm Sterile
P20-570-076S-S	Monster® Cannulated Screw, Short Thread, Headless, Ø7.0 x 76mm Sterile
P20-570-078L-S	Monster® Cannulated Screw, Long Thread, Headless, Ø7.0 x 78mm Sterile
P20-570-078M-S	Monster® Cannulated Screw, Medium Thread, Headless, Ø7.0 x 78mm Sterile
P20-570-078S-S	Monster® Cannulated Screw, Short Thread, Headless, Ø7.0 x 78mm Sterile
P20-570-080L-S	Monster® Cannulated Screw, Long Thread, Headless, Ø7.0 x 80mm Sterile
P20-570-080M-S	Monster® Cannulated Screw, Medium Thread, Headless, Ø7.0 x 80mm Sterile
P20-570-080S-S	Monster® Cannulated Screw, Short Thread, Headless, Ø7.0 x 80mm Sterile
P20-570-082L-S	Monster® Cannulated Screw, Long Thread, Headless, Ø7.0 x 82mm Sterile
P20-570-082M-S	Monster® Cannulated Screw, Medium Thread, Headless, Ø7.0 x 82mm Sterile
P20-570-082S-S	Monster® Cannulated Screw, Short Thread, Headless, Ø7.0 x 82mm Sterile
P20-570-084L-S	Monster® Cannulated Screw, Long Thread, Headless, Ø7.0 x 84mm Sterile
P20-570-084M-S	Monster® Cannulated Screw, Medium Thread, Headless, Ø7.0 x 84mm Sterile
P20-570-084S-S	Monster® Cannulated Screw, Short Thread, Headless, Ø7.0 x 84mm Sterile
P20-570-086L-S	Monster® Cannulated Screw, Long Thread, Headless, Ø7.0 x 86mm Sterile
P20-570-086M-S	Monster® Cannulated Screw, Medium Thread, Headless, Ø7.0 x 86mm Sterile
P20-570-086S-S	Monster® Cannulated Screw, Short Thread, Headless, Ø7.0 x 86mm Sterile
P20-570-088L-S	Monster® Cannulated Screw, Long Thread, Headless, Ø7.0 x 88mm Sterile
P20-570-088M-S	Monster® Cannulated Screw, Medium Thread, Headless, Ø7.0 x 88mm Sterile
P20-570-088S-S	Monster® Cannulated Screw, Short Thread, Headless, Ø7.0 x 88mm Sterile
P20-570-090L-S	Monster® Cannulated Screw, Long Thread, Headless, Ø7.0 x 90mm Sterile
P20-570-090M-S	Monster® Cannulated Screw, Medium Thread, Headless, Ø7.0 x 90mm Sterile
P20-570-090S-S	Monster® Cannulated Screw, Short Thread, Headless, Ø7.0 x 90mm Sterile
P20-570-095L-S	Monster® Cannulated Screw, Long Thread, Headless, Ø7.0 x 95mm Sterile
P20-570-095M-S	Monster® Cannulated Screw, Medium Thread, Headless, Ø7.0 x 95mm Sterile
P20-570-095S-S	Monster® Cannulated Screw, Short Thread, Headless, Ø7.0 x 95mm Sterile
P20-570-100L-S	Monster® Cannulated Screw, Long Thread, Headless, Ø7.0 x 100mm Sterile
P20-570-100M-S	Monster® Cannulated Screw, Medium Thread, Headless, Ø7.0 x 100mm Sterile
P20-570-100S-S	Monster® Cannulated Screw, Short Thread, Headless, Ø7.0 x 100mm Sterile
P20-570-105L-S	Monster® Cannulated Screw, Long Thread, Headless, Ø7.0 x 105mm Sterile
P20-570-105M-S	Monster® Cannulated Screw, Medium Thread, Headless, Ø7.0 x 105mm Sterile
P20-570-105S-S	Monster® Cannulated Screw, Short Thread, Headless, Ø7.0 x 105mm Sterile
P20-570-110L-S	Monster® Cannulated Screw, Long Thread, Headless, Ø7.0 x 110mm Sterile
P20-570-110M-S	Monster® Cannulated Screw, Medium Thread, Headless, Ø7.0 x 110mm Sterile
P20-570-110S-S	Monster® Cannulated Screw, Short Thread, Headless, Ø7.0 x 110mm Sterile
P20-570-115L-S	Monster® Cannulated Screw, Long Thread, Headless, Ø7.0 x 115mm Sterile
P20-570-115M-S	Monster® Cannulated Screw, Medium Thread, Headless, Ø7.0 x 115mm Sterile
P20-570-115S-S	Monster® Cannulated Screw, Short Thread, Headless, Ø7.0 x 115mm Sterile
P20-570-120L-S	Monster® Cannulated Screw, Long Thread, Headless, Ø7.0 x 120mm Sterile

Not all products available for sale in all markets. To determine availability in your marketplace, please contact your local Paragon 28 representative or email info@paragon28.com.

STERILE PACKAGED PRODUCT

PART NUMBER	DESCRIPTION
P20-570-120M-S	Monster® Cannulated Screw, Medium Thread, Headless, Ø7.0 x 120mm Sterile
P20-570-120S-S	Monster® Cannulated Screw, Short Thread, Headless, Ø7.0 x 120mm Sterile
P20-570-125L-S	Monster® Cannulated Screw, Long Thread, Headless, Ø7.0 x 125mm Sterile
P20-570-125M-S	Monster® Cannulated Screw, Medium Thread, Headless, Ø7.0 x 125mm Sterile
P20-570-125S-S	Monster® Cannulated Screw, Short Thread, Headless, Ø7.0 x 125mm Sterile
P20-570-130L-S	Monster® Cannulated Screw, Long Thread, Headless, Ø7.0 x 130mm Sterile
P20-570-130M-S	Monster® Cannulated Screw, Medium Thread, Headless, Ø7.0 x 130mm Sterile
P20-570-130S-S	Monster® Cannulated Screw, Short Thread, Headless, Ø7.0 x 130mm Sterile
P20-910-2000-S	Countersink, 2.0mm, Headed Sterile
P20-910-2500-S	Countersink, 2.5/2.7mm, Headed Sterile
P20-910-3000-S	Countersink, 3.0mm, Headed Sterile
P20-910-3500-S	Countersink, 3.5mm, Headed Sterile
P20-910-4000-S	Countersink, 4.0mm, Headed Sterile
P20-910-4500-S	Countersink, 4.5mm, Headed Sterile
P20-910-5500-S	Countersink, 5.5mm, Headed Sterile
P20-910-7000-S	Countersink, 7.0mm, Headed Sterile
P20-910-WB70-S	Countersink, 7.0mm, Monster® Bowl Washer Sterile
P20-911-2500-S	Countersink, 2.5mm, Headed, Solid Sterile
P20-911-3500-S	Countersink, 3.5mm, Headed, Solid Sterile
P20-911-4000-S	Countersink, 4.0mm, Headed, Solid Sterile
P20-915-2000-S	Countersink, 2.0mm, Headless Sterile
P20-915-2500-S	Countersink, 2.5mm, Headless Sterile
P20-915-3000-S	Countersink, 3.0mm, Headless Sterile
P20-915-3500-S	Countersink, 3.5mm, Headless Sterile
P20-915-4000-S	Countersink, 4.0mm, Headless Sterile
P20-915-4500-S	Countersink, 4.5mm, Headless Sterile
P20-915-5000-S	Countersink, 5.0mm, Headless Sterile
P20-915-5500-S	Countersink, 5.5mm, Headless Sterile
P20-915-7000-S	Countersink, 7.0mm, Headless Sterile
P20-915-7200-S	Countersink, 7.2mm x 150mm, Headless Sterile
P20-917-2518-S	Countersink, Combination, 2.5mm Headless, 18mm Sterile
P20-917-3018-S	Countersink, Combination, 3.0mm Headless, 18mm Sterile
P20-920-2000-S	Tap, 2.0mm, Cannulated Sterile
P20-920-2500-S	Tap, 2.5/2.7mm, Cannulated Sterile
P20-920-3000-S	Tap, 3.0mm, Cannulated Sterile
P20-920-3500-S	Tap, 3.5mm, Cannulated Sterile
P20-920-4000-S	Tap, 4.0mm, Cannulated Sterile
P20-920-4500-S	Tap, 4.5mm, Cannulated Sterile
P20-920-5500-S	Tap, 5.5mm, Cannulated Sterile
P20-920-7000-S	Tap, 7.0mm, Cannulated Sterile

Not all products available for sale in all markets. To determine availability in your marketplace, please contact your local Paragon 28 representative or email info@paragon28.com.

STERILE PACKAGED PRODUCT

PART NUMBER	DESCRIPTION
P24-020-008L-S	Monster® BITE Screw, Long Thread, Ø2.0 x 8mm Sterile
P24-020-008S-S	Monster® BITE Screw, Short Thread, Ø2.0 x 8mm Sterile
P24-020-009L-S	Monster® BITE Screw, Long Thread, Ø2.0 x 9mm Sterile
P24-020-009S-S	Monster® BITE Screw, Short Thread, Ø2.0 x 9mm Sterile
P24-020-010L-S	Monster® BITE Screw, Long Thread, Ø2.0 x 10mm Sterile
P24-020-010S-S	Monster® BITE Screw, Short Thread, Ø2.0 x 10mm Sterile
P24-020-011L-S	Monster® BITE Screw, Long Thread, Ø2.0 x 11mm Sterile
P24-020-011S-S	Monster® BITE Screw, Short Thread, Ø2.0 x 11mm Sterile
P24-020-012L-S	Monster® BITE Screw, Long Thread, Ø2.0 x 12mm Sterile
P24-020-012S-S	Monster® BITE Screw, Short Thread, Ø2.0 x 12mm Sterile
P24-020-013L-S	Monster® BITE Screw, Long Thread, Ø2.0 x 13mm Sterile
P24-020-013S-S	Monster® BITE Screw, Short Thread, Ø2.0 x 13mm Sterile
P24-020-014L-S	Monster® BITE Screw, Long Thread, Ø2.0 x 14mm Sterile
P24-020-014S-S	Monster® BITE Screw, Short Thread, Ø2.0 x 14mm Sterile
P24-020-015L-S	Monster® BITE Screw, Long Thread, Ø2.0 x 15mm Sterile
P24-020-015S-S	Monster® BITE Screw, Short Thread, Ø2.0 x 15mm Sterile
P24-020-016L-S	Monster® BITE Screw, Long Thread, Ø2.0 x 16mm Sterile
P24-020-016S-S	Monster® BITE Screw, Short Thread, Ø2.0 x 16mm Sterile
P24-027-010S-S	Monster® BITE Screw, Short Thread, Ø2.7 x 10mm Sterile
P24-027-012S-S	Monster® BITE Screw, Short Thread, Ø2.7 x 12mm Sterile
P24-027-014S-S	Monster® BITE Screw, Short Thread, Ø2.7 x 14mm Sterile
P24-027-016S-S	Monster® BITE Screw, Short Thread, Ø2.7 x 16mm Sterile
P24-027-018S-S	Monster® BITE Screw, Short Thread, Ø2.7 x 18mm Sterile
P24-027-020S-S	Monster® BITE Screw, Short Thread, Ø2.7 x 20mm Sterile
P24-027-022S-S	Monster® BITE Screw, Short Thread, Ø2.7 x 22mm Sterile
P24-027-024S-S	Monster® BITE Screw, Short Thread, Ø2.7 x 24mm Sterile
P25-240-034S-S	Precision™ Jones Screw, Cannulated, Short Thd, Blunt Tip, 4.0 x 34mm Sterile
P25-240-036S-S	Precision™ Jones Screw, Cannulated, Short Thd, Blunt Tip, 4.0 x 36mm Sterile
P25-240-038S-S	Precision™ Jones Screw, Cannulated, Short Thd, Blunt Tip, 4.0 x 38mm Sterile
P25-240-040S-S	Precision™ Jones Screw, Cannulated, Short Thd, Blunt Tip, 4.0 x 40mm Sterile
P25-240-042S-S	Precision™ Jones Screw, Cannulated, Short Thd, Blunt Tip, 4.0 x 42mm Sterile
P25-240-044S-S	Precision™ Jones Screw, Cannulated, Short Thd, Blunt Tip, 4.0 x 44mm Sterile
P25-240-046S-S	Precision™ Jones Screw, Cannulated, Short Thd, Blunt Tip, 4.0 x 46mm Sterile
P25-240-048S-S	Precision™ Jones Screw, Cannulated, Short Thd, Blunt Tip, 4.0 x 48mm Sterile
P25-240-050S-S	Precision™ Jones Screw, Cannulated, Short Thd, Blunt Tip, 4.0 x 50mm Sterile
P25-240-052S-S	Precision™ Jones Screw, Cannulated, Short Thd, Blunt Tip, 4.0 x 52mm Sterile
P25-240-054S-S	Precision™ Jones Screw, Cannulated, Short Thd, Blunt Tip, 4.0 x 54mm Sterile
P25-240-056S-S	Precision™ Jones Screw, Cannulated, Short Thd, Blunt Tip, 4.0 x 56mm Sterile
P25-240-058S-S	Precision™ Jones Screw, Cannulated, Short Thd, Blunt Tip, 4.0 x 58mm Sterile
P25-240-060S-S	Precision™ Jones Screw, Cannulated, Short Thd, Blunt Tip, 4.0 x 60mm Sterile

Not all products available for sale in all markets. To determine availability in your marketplace, please contact your local Paragon 28 representative or email info@paragon28.com.

STERILE PACKAGED PRODUCT

PART NUMBER	DESCRIPTION
P25-240-065S-S	Precision™ Jones Screw, Cannulated, Short Thd, Blunt Tip, 4.0 x 65mm Sterile
P25-245-034S-S	Precision™ Jones Screw, Cannulated, Short Thd, Blunt Tip, 4.5 x 34mm Sterile
P25-245-036S-S	Precision™ Jones Screw, Cannulated, Short Thd, Blunt Tip, 4.5 x 36mm Sterile
P25-245-038S-S	Precision™ Jones Screw, Cannulated, Short Thd, Blunt Tip, 4.5 x 38mm Sterile
P25-245-040S-S	Precision™ Jones Screw, Cannulated, Short Thd, Blunt Tip, 4.5 x 40mm Sterile
P25-245-042S-S	Precision™ Jones Screw, Cannulated, Short Thd, Blunt Tip, 4.5 x 42mm Sterile
P25-245-044S-S	Precision™ Jones Screw, Cannulated, Short Thd, Blunt Tip, 4.5 x 44mm Sterile
P25-245-046S-S	Precision™ Jones Screw, Cannulated, Short Thd, Blunt Tip, 4.5 x 46mm Sterile
P25-245-048S-S	Precision™ Jones Screw, Cannulated, Short Thd, Blunt Tip, 4.5 x 48mm Sterile
P25-245-050S-S	Precision™ Jones Screw, Cannulated, Short Thd, Blunt Tip, 4.5 x 50mm Sterile
P25-245-052S-S	Precision™ Jones Screw, Cannulated, Short Thd, Blunt Tip, 4.5 x 52mm Sterile
P25-245-054S-S	Precision™ Jones Screw, Cannulated, Short Thd, Blunt Tip, 4.5 x 54mm Sterile
P25-245-056S-S	Precision™ Jones Screw, Cannulated, Short Thd, Blunt Tip, 4.5 x 56mm Sterile
P25-245-058S-S	Precision™ Jones Screw, Cannulated, Short Thd, Blunt Tip, 4.5 x 58mm Sterile
P25-245-060S-S	Precision™ Jones Screw, Cannulated, Short Thd, Blunt Tip, 4.5 x 60mm Sterile
P25-245-065S-S	Precision™ Jones Screw, Cannulated, Short Thd, Blunt Tip, 4.5 x 65mm Sterile
P25-255-034S-S	Precision™ Jones Screw, Cannulated, Short Thd, Blunt Tip, 5.5 x 34mm Sterile
P25-255-036S-S	Precision™ Jones Screw, Cannulated, Short Thd, Blunt Tip, 5.5 x 36mm Sterile
P25-255-038S-S	Precision™ Jones Screw, Cannulated, Short Thd, Blunt Tip, 5.5 x 38mm Sterile
P25-255-040S-S	Precision™ Jones Screw, Cannulated, Short Thd, Blunt Tip, 5.5 x 40mm Sterile
P25-255-042S-S	Precision™ Jones Screw, Cannulated, Short Thd, Blunt Tip, 5.5 x 42mm Sterile
P25-255-044S-S	Precision™ Jones Screw, Cannulated, Short Thd, Blunt Tip, 5.5 x 44mm Sterile
P25-255-046S-S	Precision™ Jones Screw, Cannulated, Short Thd, Blunt Tip, 5.5 x 46mm Sterile
P25-255-048S-S	Precision™ Jones Screw, Cannulated, Short Thd, Blunt Tip, 5.5 x 48mm Sterile
P25-255-050S-S	Precision™ Jones Screw, Cannulated, Short Thd, Blunt Tip, 5.5 x 50mm Sterile
P25-255-052S-S	Precision™ Jones Screw, Cannulated, Short Thd, Blunt Tip, 5.5 x 52mm Sterile
P25-255-054S-S	Precision™ Jones Screw, Cannulated, Short Thd, Blunt Tip, 5.5 x 54mm Sterile
P25-255-056S-S	Precision™ Jones Screw, Cannulated, Short Thd, Blunt Tip, 5.5 x 56mm Sterile
P25-255-058S-S	Precision™ Jones Screw, Cannulated, Short Thd, Blunt Tip, 5.5 x 58mm Sterile
P25-255-060S-S	Precision™ Jones Screw, Cannulated, Short Thd, Blunt Tip, 5.5 x 60mm Sterile
P25-255-065S-S	Precision™ Jones Screw, Cannulated, Short Thd, Blunt Tip, 5.5 x 65mm Sterile
P25-262-034S-S	Precision™ Jones Screw, Cannulated, Short Thd, Blunt Tip, 6.2 x 34mm Sterile
P25-262-036S-S	Precision™ Jones Screw, Cannulated, Short Thd, Blunt Tip, 6.2 x 36mm Sterile
P25-262-038S-S	Precision™ Jones Screw, Cannulated, Short Thd, Blunt Tip, 6.2 x 38mm Sterile
P25-262-040S-S	Precision™ Jones Screw, Cannulated, Short Thd, Blunt Tip, 6.2 x 40mm Sterile
P25-262-042S-S	Precision™ Jones Screw, Cannulated, Short Thd, Blunt Tip, 6.2 x 42mm Sterile
P25-262-044S-S	Precision™ Jones Screw, Cannulated, Short Thd, Blunt Tip, 6.2 x 44mm Sterile
P25-262-046S-S	Precision™ Jones Screw, Cannulated, Short Thd, Blunt Tip, 6.2 x 46mm Sterile
P25-262-048S-S	Precision™ Jones Screw, Cannulated, Short Thd, Blunt Tip, 6.2 x 48mm Sterile
P25-262-050S-S	Precision™ Jones Screw, Cannulated, Short Thd, Blunt Tip, 6.2 x 50mm Sterile

Not all products available for sale in all markets. To determine availability in your marketplace, please contact your local Paragon 28 representative or email info@paragon28.com.

STERILE PACKAGED PRODUCT

PART NUMBER	DESCRIPTION
P25-262-052S-S	Precision™ Jones Screw, Cannulated, Short Thd, Blunt Tip, 6.2 x 52mm Sterile
P25-262-054S-S	Precision™ Jones Screw, Cannulated, Short Thd, Blunt Tip, 6.2 x 54mm Sterile
P25-262-056S-S	Precision™ Jones Screw, Cannulated, Short Thd, Blunt Tip, 6.2 x 56mm Sterile
P25-262-058S-S	Precision™ Jones Screw, Cannulated, Short Thd, Blunt Tip, 6.2 x 58mm Sterile
P25-262-060S-S	Precision™ Jones Screw, Cannulated, Short Thd, Blunt Tip, 6.2 x 60mm Sterile
P25-262-065S-S	Precision™ Jones Screw, Cannulated, Short Thd, Blunt Tip, 6.2 x 65mm Sterile
P25-440-034S-S	Precision™ Jones Screw, Solid, Short Thd, Blunt Tip, 4.0 x 34mm Sterile
P25-440-036S-S	Precision™ Jones Screw, Solid, Short Thd, Blunt Tip, 4.0 x 36mm Sterile
P25-440-038S-S	Precision™ Jones Screw, Solid, Short Thd, Blunt Tip, 4.0 x 38mm Sterile
P25-440-040S-S	Precision™ Jones Screw, Solid, Short Thd, Blunt Tip, 4.0 x 40mm Sterile
P25-440-042S-S	Precision™ Jones Screw, Solid, Short Thd, Blunt Tip, 4.0 x 42mm Sterile
P25-440-044S-S	Precision™ Jones Screw, Solid, Short Thd, Blunt Tip, 4.0 x 44mm Sterile
P25-440-046S-S	Precision™ Jones Screw, Solid, Short Thd, Blunt Tip, 4.0 x 46mm Sterile
P25-440-048S-S	Precision™ Jones Screw, Solid, Short Thd, Blunt Tip, 4.0 x 48mm Sterile
P25-440-050S-S	Precision™ Jones Screw, Solid, Short Thd, Blunt Tip, 4.0 x 50mm Sterile
P25-440-052S-S	Precision™ Jones Screw, Solid, Short Thd, Blunt Tip, 4.0 x 52mm Sterile
P25-440-054S-S	Precision™ Jones Screw, Solid, Short Thd, Blunt Tip, 4.0 x 54mm Sterile
P25-440-056S-S	Precision™ Jones Screw, Solid, Short Thd, Blunt Tip, 4.0 x 56mm Sterile
P25-440-058S-S	Precision™ Jones Screw, Solid, Short Thd, Blunt Tip, 4.0 x 58mm Sterile
P25-440-060S-S	Precision™ Jones Screw, Solid, Short Thd, Blunt Tip, 4.0 x 60mm Sterile
P25-440-065S-S	Precision™ Jones Screw, Solid, Short Thd, Blunt Tip, 4.0 x 65mm Sterile
P25-445-034S-S	Precision™ Jones Screw, Solid, Short Thd, Blunt Tip, 4.5 x 34mm Sterile
P25-445-036S-S	Precision™ Jones Screw, Solid, Short Thd, Blunt Tip, 4.5 x 36mm Sterile
P25-445-038S-S	Precision™ Jones Screw, Solid, Short Thd, Blunt Tip, 4.5 x 38mm Sterile
P25-445-040S-S	Precision™ Jones Screw, Solid, Short Thd, Blunt Tip, 4.5 x 40mm Sterile
P25-445-042S-S	Precision™ Jones Screw, Solid, Short Thd, Blunt Tip, 4.5 x 42mm Sterile
P25-445-044S-S	Precision™ Jones Screw, Solid, Short Thd, Blunt Tip, 4.5 x 44mm Sterile
P25-445-046S-S	Precision™ Jones Screw, Solid, Short Thd, Blunt Tip, 4.5 x 46mm Sterile
P25-445-048S-S	Precision™ Jones Screw, Solid, Short Thd, Blunt Tip, 4.5 x 48mm Sterile
P25-445-050S-S	Precision™ Jones Screw, Solid, Short Thd, Blunt Tip, 4.5 x 50mm Sterile
P25-445-052S-S	Precision™ Jones Screw, Solid, Short Thd, Blunt Tip, 4.5 x 52mm Sterile
P25-445-054S-S	Precision™ Jones Screw, Solid, Short Thd, Blunt Tip, 4.5 x 54mm Sterile
P25-445-056S-S	Precision™ Jones Screw, Solid, Short Thd, Blunt Tip, 4.5 x 56mm Sterile
P25-445-058S-S	Precision™ Jones Screw, Solid, Short Thd, Blunt Tip, 4.5 x 58mm Sterile
P25-445-060S-S	Precision™ Jones Screw, Solid, Short Thd, Blunt Tip, 4.5 x 60mm Sterile
P25-445-065S-S	Precision™ Jones Screw, Solid, Short Thd, Blunt Tip, 4.5 x 65mm Sterile
P25-455-034S-S	Precision™ Jones Screw, Solid, Short Thd, Blunt Tip, 5.5 x 34mm Sterile
P25-455-036S-S	Precision™ Jones Screw, Solid, Short Thd, Blunt Tip, 5.5 x 36mm Sterile
P25-455-038S-S	Precision™ Jones Screw, Solid, Short Thd, Blunt Tip, 5.5 x 38mm Sterile
P25-455-040S-S	Precision™ Jones Screw, Solid, Short Thd, Blunt Tip, 5.5 x 40mm Sterile

Not all products available for sale in all markets. To determine availability in your marketplace, please contact your local Paragon 28 representative or email info@paragon28.com.

STERILE PACKAGED PRODUCT

PART NUMBER	DESCRIPTION
P25-455-042S-S	Precision™ Jones Screw, Solid, Short Thd, Blunt Tip, 5.5 x 42mm Sterile
P25-455-044S-S	Precision™ Jones Screw, Solid, Short Thd, Blunt Tip, 5.5 x 44mm Sterile
P25-455-046S-S	Precision™ Jones Screw, Solid, Short Thd, Blunt Tip, 5.5 x 46mm Sterile
P25-455-048S-S	Precision™ Jones Screw, Solid, Short Thd, Blunt Tip, 5.5 x 48mm Sterile
P25-455-050S-S	Precision™ Jones Screw, Solid, Short Thd, Blunt Tip, 5.5 x 50mm Sterile
P25-455-052S-S	Precision™ Jones Screw, Solid, Short Thd, Blunt Tip, 5.5 x 52mm Sterile
P25-455-054S-S	Precision™ Jones Screw, Solid, Short Thd, Blunt Tip, 5.5 x 54mm Sterile
P25-455-056S-S	Precision™ Jones Screw, Solid, Short Thd, Blunt Tip, 5.5 x 56mm Sterile
P25-455-058S-S	Precision™ Jones Screw, Solid, Short Thd, Blunt Tip, 5.5 x 58mm Sterile
P25-455-060S-S	Precision™ Jones Screw, Solid, Short Thd, Blunt Tip, 5.5 x 60mm Sterile
P25-455-065S-S	Precision™ Jones Screw, Solid, Short Thd, Blunt Tip, 5.5 x 65mm Sterile
P25-462-034S-S	Precision™ Jones Screw, Solid, Short Thd, Blunt Tip, 6.2 x 34mm Sterile
P25-462-036S-S	Precision™ Jones Screw, Solid, Short Thd, Blunt Tip, 6.2 x 36mm Sterile
P25-462-038S-S	Precision™ Jones Screw, Solid, Short Thd, Blunt Tip, 6.2 x 38mm Sterile
P25-462-040S-S	Precision™ Jones Screw, Solid, Short Thd, Blunt Tip, 6.2 x 40mm Sterile
P25-462-042S-S	Precision™ Jones Screw, Solid, Short Thd, Blunt Tip, 6.2 x 42mm Sterile
P25-462-044S-S	Precision™ Jones Screw, Solid, Short Thd, Blunt Tip, 6.2 x 44mm Sterile
P25-462-046S-S	Precision™ Jones Screw, Solid, Short Thd, Blunt Tip, 6.2 x 46mm Sterile
P25-462-048S-S	Precision™ Jones Screw, Solid, Short Thd, Blunt Tip, 6.2 x 48mm Sterile
P25-462-050S-S	Precision™ Jones Screw, Solid, Short Thd, Blunt Tip, 6.2 x 50mm Sterile
P25-462-052S-S	Precision™ Jones Screw, Solid, Short Thd, Blunt Tip, 6.2 x 52mm Sterile
P25-462-054S-S	Precision™ Jones Screw, Solid, Short Thd, Blunt Tip, 6.2 x 54mm Sterile
P25-462-056S-S	Precision™ Jones Screw, Solid, Short Thd, Blunt Tip, 6.2 x 56mm Sterile
P25-462-058S-S	Precision™ Jones Screw, Solid, Short Thd, Blunt Tip, 6.2 x 58mm Sterile
P25-462-060S-S	Precision™ Jones Screw, Solid, Short Thd, Blunt Tip, 6.2 x 60mm Sterile
P25-462-065S-S	Precision™ Jones Screw, Solid, Short Thd, Blunt Tip, 6.2 x 65mm Sterile
P25-910-4045-S	Countersink, 4.0/4.5mm, Headed Jones Screw
P25-910-5500-S	Countersink, 5.5mm, Headed Jones Screw
P25-910-6200-S	Countersink, 6.2mm, Headed Jones Screw
P25-920-4000-S	Tap, 4.0mm, Cannulated Jones Screw
P25-920-4500-S	Tap, 4.5mm, Cannulated Jones Screw
P25-920-5500-S	Tap, 5.5mm, Cannulated Jones Screw
P25-920-6200-S	Tap, 6.2mm, Cannulated Jones Screw
P26-550-050F-S	JOUST™ Beam, Cannulated, Headless, Full Thd, 5.0 x 50mm Sterile
P26-550-050M-S	JOUST™ Beam, Cannulated, Headless, Medium Thd, 5.0 x 50mm Sterile
P26-550-055F-S	JOUST™ Beam, Cannulated, Headless, Full Thd, 5.0 x 55mm Sterile
P26-550-055M-S	JOUST™ Beam, Cannulated, Headless, Medium Thd, 5.0 x 55mm Sterile
P26-550-060F-S	JOUST™ Beam, Cannulated, Headless, Full Thd, 5.0 x 60mm Sterile
P26-550-060M-S	JOUST™ Beam, Cannulated, Headless, Medium Thd, 5.0 x 60mm Sterile
P26-550-065F-S	JOUST™ Beam, Cannulated, Headless, Full Thd, 5.0 x 65mm Sterile

Not all products available for sale in all markets. To determine availability in your marketplace, please contact your local Paragon 28 representative or email info@paragon28.com.

STERILE PACKAGED PRODUCT

PART NUMBER	DESCRIPTION
P26-550-065M-S	JOUST™ Beam, Cannulated, Headless, Medium Thd, 5.0 x 65mm Sterile
P26-550-070F-S	JOUST™ Beam, Cannulated, Headless, Full Thd, 5.0 x 70mm Sterile
P26-550-070M-S	JOUST™ Beam, Cannulated, Headless, Medium Thd, 5.0 x 70mm Sterile
P26-550-075F-S	JOUST™ Beam, Cannulated, Headless, Full Thd, 5.0 x 75mm Sterile
P26-550-075M-S	JOUST™ Beam, Cannulated, Headless, Medium Thd, 5.0 x 75mm Sterile
P26-550-080F-S	JOUST™ Beam, Cannulated, Headless, Full Thd, 5.0 x 80mm Sterile
P26-550-080M-S	JOUST™ Beam, Cannulated, Headless, Medium Thd, 5.0 x 80mm Sterile
P26-550-085F-S	JOUST™ Beam, Cannulated, Headless, Full Thd, 5.0 x 85mm Sterile
P26-550-085M-S	JOUST™ Beam, Cannulated, Headless, Medium Thd, 5.0 x 85mm Sterile
P26-550-090F-S	JOUST™ Beam, Cannulated, Headless, Full Thd, 5.0 x 90mm Sterile
P26-550-090M-S	JOUST™ Beam, Cannulated, Headless, Medium Thd, 5.0 x 90mm Sterile
P26-550-095F-S	JOUST™ Beam, Cannulated, Headless, Full Thd, 5.0 x 95mm Sterile
P26-550-095M-S	JOUST™ Beam, Cannulated, Headless, Medium Thd, 5.0 x 95mm Sterile
P26-550-100F-S	JOUST™ Beam, Cannulated, Headless, Full Thd, 5.0 x 100mm Sterile
P26-550-100M-S	JOUST™ Beam, Cannulated, Headless, Medium Thd, 5.0 x 100mm Sterile
P26-550-105F-S	JOUST™ Beam, Cannulated, Headless, Full Thd, 5.0 x 105mm Sterile
P26-550-105M-S	JOUST™ Beam, Cannulated, Headless, Medium Thd, 5.0 x 105mm Sterile
P26-550-110F-S	JOUST™ Beam, Cannulated, Headless, Full Thd, 5.0 x 110mm Sterile
P26-550-110M-S	JOUST™ Beam, Cannulated, Headless, Medium Thd, 5.0 x 110mm Sterile
P26-550-115F-S	JOUST™ Beam, Cannulated, Headless, Full Thd, 5.0 x 115mm Sterile
P26-550-115M-S	JOUST™ Beam, Cannulated, Headless, Medium Thd, 5.0 x 115mm Sterile
P26-550-120F-S	JOUST™ Beam, Cannulated, Headless, Full Thd, 5.0 x 120mm Sterile
P26-550-120M-S	JOUST™ Beam, Cannulated, Headless, Medium Thd, 5.0 x 120mm Sterile
P26-555-050F-S	JOUST™ Beam, Cannulated, Headless, Full Thd, 5.5 x 50mm Sterile
P26-555-050M-S	JOUST™ Beam, Cannulated, Headless, Medium Thd, 5.5 x 50mm Sterile
P26-555-055F-S	JOUST™ Beam, Cannulated, Headless, Full Thd, 5.5 x 55mm Sterile
P26-555-055M-S	JOUST™ Beam, Cannulated, Headless, Medium Thd, 5.5 x 55mm Sterile
P26-555-060F-S	JOUST™ Beam, Cannulated, Headless, Full Thd, 5.5 x 60mm Sterile
P26-555-060M-S	JOUST™ Beam, Cannulated, Headless, Medium Thd, 5.5 x 60mm Sterile
P26-555-065F-S	JOUST™ Beam, Cannulated, Headless, Full Thd, 5.5 x 65mm Sterile
P26-555-065M-S	JOUST™ Beam, Cannulated, Headless, Medium Thd, 5.5 x 65mm Sterile
P26-555-070F-S	JOUST™ Beam, Cannulated, Headless, Full Thd, 5.5 x 70mm Sterile
P26-555-070M-S	JOUST™ Beam, Cannulated, Headless, Medium Thd, 5.5 x 70mm Sterile
P26-555-075F-S	JOUST™ Beam, Cannulated, Headless, Full Thd, 5.5 x 75mm Sterile
P26-555-075M-S	JOUST™ Beam, Cannulated, Headless, Medium Thd, 5.5 x 75mm Sterile
P26-555-080F-S	JOUST™ Beam, Cannulated, Headless, Full Thd, 5.5 x 80mm Sterile
P26-555-080M-S	JOUST™ Beam, Cannulated, Headless, Medium Thd, 5.5 x 80mm Sterile
P26-555-085F-S	JOUST™ Beam, Cannulated, Headless, Full Thd, 5.5 x 85mm Sterile
P26-555-085M-S	JOUST™ Beam, Cannulated, Headless, Medium Thd, 5.5 x 85mm Sterile
P26-555-090F-S	JOUST™ Beam, Cannulated, Headless, Full Thd, 5.5 x 90mm Sterile

Not all products available for sale in all markets. To determine availability in your marketplace, please contact your local Paragon 28 representative or email info@paragon28.com.

STERILE PACKAGED PRODUCT

PART NUMBER	DESCRIPTION
P26-555-090M-S	JOUST™ Beam, Cannulated, Headless, Medium Thd, 5.5 x 90mm Sterile
P26-555-095F-S	JOUST™ Beam, Cannulated, Headless, Full Thd, 5.5 x 95mm Sterile
P26-555-095M-S	JOUST™ Beam, Cannulated, Headless, Medium Thd, 5.5 x 95mm Sterile
P26-555-100F-S	JOUST™ Beam, Cannulated, Headless, Full Thd, 5.5 x 100mm Sterile
P26-555-100M-S	JOUST™ Beam, Cannulated, Headless, Medium Thd, 5.5 x 100mm Sterile
P26-555-105F-S	JOUST™ Beam, Cannulated, Headless, Full Thd, 5.5 x 105mm Sterile
P26-555-105M-S	JOUST™ Beam, Cannulated, Headless, Medium Thd, 5.5 x 105mm Sterile
P26-555-110F-S	JOUST™ Beam, Cannulated, Headless, Full Thd, 5.5 x 110mm Sterile
P26-555-110M-S	JOUST™ Beam, Cannulated, Headless, Medium Thd, 5.5 x 110mm Sterile
P26-555-115F-S	JOUST™ Beam, Cannulated, Headless, Full Thd, 5.5 x 115mm Sterile
P26-555-115M-S	JOUST™ Beam, Cannulated, Headless, Medium Thd, 5.5 x 115mm Sterile
P26-555-120F-S	JOUST™ Beam, Cannulated, Headless, Full Thd, 5.5 x 120mm Sterile
P26-555-120M-S	JOUST™ Beam, Cannulated, Headless, Medium Thd, 5.5 x 120mm Sterile
P26-572-065F-S	JOUST™ Beam, Cannulated, Headless, Full Thd, 7.2 x 65mm Sterile
P26-572-065M-S	JOUST™ Beam, Cannulated, Headless, Medium Thd, 7.2 x 65mm Sterile
P26-572-070F-S	JOUST™ Beam, Cannulated, Headless, Full Thd, 7.2 x 70mm Sterile
P26-572-070M-S	JOUST™ Beam, Cannulated, Headless, Medium Thd, 7.2 x 70mm Sterile
P26-572-075F-S	JOUST™ Beam, Cannulated, Headless, Full Thd, 7.2 x 75mm Sterile
P26-572-075M-S	JOUST™ Beam, Cannulated, Headless, Medium Thd, 7.2 x 75mm Sterile
P26-572-080F-S	JOUST™ Beam, Cannulated, Headless, Full Thd, 7.2 x 80mm Sterile
P26-572-080M-S	JOUST™ Beam, Cannulated, Headless, Medium Thd, 7.2 x 80mm Sterile
P26-572-085F-S	JOUST™ Beam, Cannulated, Headless, Full Thd, 7.2 x 85mm Sterile
P26-572-085M-S	JOUST™ Beam, Cannulated, Headless, Medium Thd, 7.2 x 85mm Sterile
P26-572-090F-S	JOUST™ Beam, Cannulated, Headless, Full Thd, 7.2 x 90mm Sterile
P26-572-090M-S	JOUST™ Beam, Cannulated, Headless, Medium Thd, 7.2 x 90mm Sterile
P26-572-095F-S	JOUST™ Beam, Cannulated, Headless, Full Thd, 7.2 x 95mm Sterile
P26-572-095M-S	JOUST™ Beam, Cannulated, Headless, Medium Thd, 7.2 x 95mm Sterile
P26-572-100F-S	JOUST™ Beam, Cannulated, Headless, Full Thd, 7.2 x 100mm Sterile
P26-572-100M-S	JOUST™ Beam, Cannulated, Headless, Medium Thd, 7.2 x 100mm Sterile
P26-572-105F-S	JOUST™ Beam, Cannulated, Headless, Full Thd, 7.2 x 105mm Sterile
P26-572-105M-S	JOUST™ Beam, Cannulated, Headless, Medium Thd, 7.2 x 105mm Sterile
P26-572-110F-S	JOUST™ Beam, Cannulated, Headless, Full Thd, 7.2 x 110mm Sterile
P26-572-110M-S	JOUST™ Beam, Cannulated, Headless, Medium Thd, 7.2 x 110mm Sterile
P26-572-115F-S	JOUST™ Beam, Cannulated, Headless, Full Thd, 7.2 x 115mm Sterile
P26-572-115M-S	JOUST™ Beam, Cannulated, Headless, Medium Thd, 7.2 x 115mm Sterile
P26-572-120F-S	JOUST™ Beam, Cannulated, Headless, Full Thd, 7.2 x 120mm Sterile
P26-572-120M-S	JOUST™ Beam, Cannulated, Headless, Medium Thd, 7.2 x 120mm Sterile
P26-572-125F-S	JOUST™ Beam, Cannulated, Headless, Full Thd, 7.2 x 125mm Sterile
P26-572-125M-S	JOUST™ Beam, Cannulated, Headless, Medium Thd, 7.2 x 125mm Sterile
P26-572-130F-S	JOUST™ Beam, Cannulated, Headless, Full Thd, 7.2 x 130mm Sterile

Not all products available for sale in all markets. To determine availability in your marketplace, please contact your local Paragon 28 representative or email info@paragon28.com.

STERILE PACKAGED PRODUCT

PART NUMBER	DESCRIPTION
P26-572-130M-S	JOUST™ Beam, Cannulated, Headless, Medium Thd, 7.2 x 130mm Sterile
P26-572-135F-S	JOUST™ Beam, Cannulated, Headless, Full Thd, 7.2 x 135mm Sterile
P26-572-135M-S	JOUST™ Beam, Cannulated, Headless, Medium Thd, 7.2 x 135mm Sterile
P26-572-140F-S	JOUST™ Beam, Cannulated, Headless, Full Thd, 7.2 x 140mm Sterile
P26-572-140M-S	JOUST™ Beam, Cannulated, Headless, Medium Thd, 7.2 x 140mm Sterile
P26-572-145F-S	JOUST™ Beam, Cannulated, Headless, Full Thd, 7.2 x 145mm Sterile
P26-572-145M-S	JOUST™ Beam, Cannulated, Headless, Medium Thd, 7.2 x 145mm Sterile
P26-572-150F-S	JOUST™ Beam, Cannulated, Headless, Full Thd, 7.2 x 150mm Sterile
P26-572-150M-S	JOUST™ Beam, Cannulated, Headless, Medium Thd, 7.2 x 150mm Sterile
P26-572-155F-S	JOUST™ Beam, Cannulated, Headless, Full Thd, 7.2 x 155mm Sterile
P26-572-155M-S	JOUST™ Beam, Cannulated, Headless, Medium Thd, 7.2 x 155mm Sterile
P26-572-160F-S	JOUST™ Beam, Cannulated, Headless, Full Thd, 7.2 x 160mm Sterile
P26-572-160M-S	JOUST™ Beam, Cannulated, Headless, Medium Thd, 7.2 x 160mm Sterile
P26-572-165F-S	JOUST™ Beam, Cannulated, Headless, Full Thd, 7.2 x 165mm Sterile
P26-572-165M-S	JOUST™ Beam, Cannulated, Headless, Medium Thd, 7.2 x 165mm Sterile
P26-572-170F-S	JOUST™ Beam, Cannulated, Headless, Full Thd, 7.2 x 170mm Sterile
P26-572-170M-S	JOUST™ Beam, Cannulated, Headless, Medium Thd, 7.2 x 170mm Sterile
P26-572-175F-S	JOUST™ Beam, Cannulated, Headless, Full Thd, 7.2 x 175mm Sterile
P26-572-175M-S	JOUST™ Beam, Cannulated, Headless, Medium Thd, 7.2 x 175mm Sterile
P26-572-180F-S	JOUST™ Beam, Cannulated, Headless, Full Thd, 7.2 x 180mm Sterile
P26-572-180M-S	JOUST™ Beam, Cannulated, Headless, Medium Thd, 7.2 x 180mm Sterile
P26-572-185F-S	JOUST™ Beam, Cannulated, Headless, Full Thd, 7.2 x 185mm Sterile
P26-572-185M-S	JOUST™ Beam, Cannulated, Headless, Medium Thd, 7.2 x 185mm Sterile
P26-750-050F-S	JOUST™ Beam, Solid, Headless, Full Thd, 5.0 x 50mm Sterile
P26-750-050M-S	JOUST™ Beam, Solid, Headless, Medium Thd, 5.0 x 50mm Sterile
P26-750-055F-S	JOUST™ Beam, Solid, Headless, Full Thd, 5.0 x 55mm Sterile
P26-750-055M-S	JOUST™ Beam, Solid, Headless, Medium Thd, 5.0 x 55mm Sterile
P26-750-060F-S	JOUST™ Beam, Solid, Headless, Full Thd, 5.0 x 60mm Sterile
P26-750-060M-S	JOUST™ Beam, Solid, Headless, Medium Thd, 5.0 x 60mm Sterile
P26-750-065F-S	JOUST™ Beam, Solid, Headless, Full Thd, 5.0 x 65mm Sterile
P26-750-065M-S	JOUST™ Beam, Solid, Headless, Medium Thd, 5.0 x 65mm Sterile
P26-750-070F-S	JOUST™ Beam, Solid, Headless, Full Thd, 5.0 x 70mm Sterile
P26-750-070M-S	JOUST™ Beam, Solid, Headless, Medium Thd, 5.0 x 70mm Sterile
P26-750-075F-S	JOUST™ Beam, Solid, Headless, Full Thd, 5.0 x 75mm Sterile
P26-750-075M-S	JOUST™ Beam, Solid, Headless, Medium Thd, 5.0 x 75mm Sterile
P26-750-080F-S	JOUST™ Beam, Solid, Headless, Full Thd, 5.0 x 80mm Sterile
P26-750-080M-S	JOUST™ Beam, Solid, Headless, Medium Thd, 5.0 x 80mm Sterile
P26-750-085F-S	JOUST™ Beam, Solid, Headless, Full Thd, 5.0 x 85mm Sterile
P26-750-085M-S	JOUST™ Beam, Solid, Headless, Medium Thd, 5.0 x 85mm Sterile
P26-750-090F-S	JOUST™ Beam, Solid, Headless, Full Thd, 5.0 x 90mm Sterile

Not all products available for sale in all markets. To determine availability in your marketplace, please contact your local Paragon 28 representative or email info@paragon28.com.

STERILE PACKAGED PRODUCT

PART NUMBER	DESCRIPTION
P26-750-090M-S	JOUST™ Beam, Solid, Headless, Medium Thd, 5.0 x 90mm Sterile
P26-750-095F-S	JOUST™ Beam, Solid, Headless, Full Thd, 5.0 x 95mm Sterile
P26-750-095M-S	JOUST™ Beam, Solid, Headless, Medium Thd, 5.0 x 95mm Sterile
P26-750-100F-S	JOUST™ Beam, Solid, Headless, Full Thd, 5.0 x 100mm Sterile
P26-750-100M-S	JOUST™ Beam, Solid, Headless, Medium Thd, 5.0 x 100mm Sterile
P26-750-105F-S	JOUST™ Beam, Solid, Headless, Full Thd, 5.0 x 105mm Sterile
P26-750-105M-S	JOUST™ Beam, Solid, Headless, Medium Thd, 5.0 x 105mm Sterile
P26-750-110F-S	JOUST™ Beam, Solid, Headless, Full Thd, 5.0 x 110mm Sterile
P26-750-110M-S	JOUST™ Beam, Solid, Headless, Medium Thd, 5.0 x 110mm Sterile
P26-750-115F-S	JOUST™ Beam, Solid, Headless, Full Thd, 5.0 x 115mm Sterile
P26-750-115M-S	JOUST™ Beam, Solid, Headless, Medium Thd, 5.0 x 115mm Sterile
P26-750-120F-S	JOUST™ Beam, Solid, Headless, Full Thd, 5.0 x 120mm Sterile
P26-750-120M-S	JOUST™ Beam, Solid, Headless, Medium Thd, 5.0 x 120mm Sterile
P26-755-050F-S	JOUST™ Beam, Solid, Headless, Full Thd, 5.5 x 50mm Sterile
P26-755-050M-S	JOUST™ Beam, Solid, Headless, Medium Thd, 5.5 x 50mm Sterile
P26-755-055F-S	JOUST™ Beam, Solid, Headless, Full Thd, 5.5 x 55mm Sterile
P26-755-055M-S	JOUST™ Beam, Solid, Headless, Medium Thd, 5.5 x 55mm Sterile
P26-755-060F-S	JOUST™ Beam, Solid, Headless, Full Thd, 5.5 x 60mm Sterile
P26-755-060M-S	JOUST™ Beam, Solid, Headless, Medium Thd, 5.5 x 60mm Sterile
P26-755-065F-S	JOUST™ Beam, Solid, Headless, Full Thd, 5.5 x 65mm Sterile
P26-755-065M-S	JOUST™ Beam, Solid, Headless, Medium Thd, 5.5 x 65mm Sterile
P26-755-070F-S	JOUST™ Beam, Solid, Headless, Full Thd, 5.5 x 70mm Sterile
P26-755-070M-S	JOUST™ Beam, Solid, Headless, Medium Thd, 5.5 x 70mm Sterile
P26-755-075F-S	JOUST™ Beam, Solid, Headless, Full Thd, 5.5 x 75mm Sterile
P26-755-075M-S	JOUST™ Beam, Solid, Headless, Medium Thd, 5.5 x 75mm Sterile
P26-755-080F-S	JOUST™ Beam, Solid, Headless, Full Thd, 5.5 x 80mm Sterile
P26-755-080M-S	JOUST™ Beam, Solid, Headless, Medium Thd, 5.5 x 80mm Sterile
P26-755-085F-S	JOUST™ Beam, Solid, Headless, Full Thd, 5.5 x 85mm Sterile
P26-755-085M-S	JOUST™ Beam, Solid, Headless, Medium Thd, 5.5 x 85mm Sterile
P26-755-090F-S	JOUST™ Beam, Solid, Headless, Full Thd, 5.5 x 90mm Sterile
P26-755-090M-S	JOUST™ Beam, Solid, Headless, Medium Thd, 5.5 x 90mm Sterile
P26-755-095F-S	JOUST™ Beam, Solid, Headless, Full Thd, 5.5 x 95mm Sterile
P26-755-095M-S	JOUST™ Beam, Solid, Headless, Medium Thd, 5.5 x 95mm Sterile
P26-755-100F-S	JOUST™ Beam, Solid, Headless, Full Thd, 5.5 x 100mm Sterile
P26-755-100M-S	JOUST™ Beam, Solid, Headless, Medium Thd, 5.5 x 100mm Sterile
P26-755-105F-S	JOUST™ Beam, Solid, Headless, Full Thd, 5.5 x 105mm Sterile
P26-755-105M-S	JOUST™ Beam, Solid, Headless, Medium Thd, 5.5 x 105mm Sterile
P26-755-110F-S	JOUST™ Beam, Solid, Headless, Full Thd, 5.5 x 110mm Sterile
P26-755-110M-S	JOUST™ Beam, Solid, Headless, Medium Thd, 5.5 x 110mm Sterile
P26-755-115F-S	JOUST™ Beam, Solid, Headless, Full Thd, 5.5 x 115mm Sterile

Not all products available for sale in all markets. To determine availability in your marketplace, please contact your local Paragon 28 representative or email info@paragon28.com.

STERILE PACKAGED PRODUCT

PART NUMBER	DESCRIPTION
P26-755-115M-S	JOUST™ Beam, Solid, Headless, Medium Thd, 5.5 x 115mm Sterile
P26-755-120F-S	JOUST™ Beam, Solid, Headless, Full Thd, 5.5 x 120mm Sterile
P26-755-120M-S	JOUST™ Beam, Solid, Headless, Medium Thd, 5.5 x 120mm Sterile
P26-772-065F-S	JOUST™ Beam, Solid, Headless, Full Thd, 7.2 x 65mm Sterile
P26-772-065M-S	JOUST™ Beam, Solid, Headless, Medium Thd, 7.2 x 65mm Sterile
P26-772-070F-S	JOUST™ Beam, Solid, Headless, Full Thd, 7.2 x 70mm Sterile
P26-772-070M-S	JOUST™ Beam, Solid, Headless, Medium Thd, 7.2 x 70mm Sterile
P26-772-075F-S	JOUST™ Beam, Solid, Headless, Full Thd, 7.2 x 75mm Sterile
P26-772-075M-S	JOUST™ Beam, Solid, Headless, Medium Thd, 7.2 x 75mm Sterile
P26-772-080F-S	JOUST™ Beam, Solid, Headless, Full Thd, 7.2 x 80mm Sterile
P26-772-080M-S	JOUST™ Beam, Solid, Headless, Medium Thd, 7.2 x 80mm Sterile
P26-772-085F-S	JOUST™ Beam, Solid, Headless, Full Thd, 7.2 x 85mm Sterile
P26-772-085M-S	JOUST™ Beam, Solid, Headless, Medium Thd, 7.2 x 85mm Sterile
P26-772-090F-S	JOUST™ Beam, Solid, Headless, Full Thd, 7.2 x 90mm Sterile
P26-772-090M-S	JOUST™ Beam, Solid, Headless, Medium Thd, 7.2 x 90mm Sterile
P26-772-095F-S	JOUST™ Beam, Solid, Headless, Full Thd, 7.2 x 95mm Sterile
P26-772-095M-S	JOUST™ Beam, Solid, Headless, Medium Thd, 7.2 x 95mm Sterile
P26-772-100F-S	JOUST™ Beam, Solid, Headless, Full Thd, 7.2 x 100mm Sterile
P26-772-100M-S	JOUST™ Beam, Solid, Headless, Medium Thd, 7.2 x 100mm Sterile
P26-772-105F-S	JOUST™ Beam, Solid, Headless, Full Thd, 7.2 x 105mm Sterile
P26-772-105M-S	JOUST™ Beam, Solid, Headless, Medium Thd, 7.2 x 105mm Sterile
P26-772-110F-S	JOUST™ Beam, Solid, Headless, Full Thd, 7.2 x 110mm Sterile
P26-772-110M-S	JOUST™ Beam, Solid, Headless, Medium Thd, 7.2 x 110mm Sterile
P26-772-115F-S	JOUST™ Beam, Solid, Headless, Full Thd, 7.2 x 115mm Sterile
P26-772-115M-S	JOUST™ Beam, Solid, Headless, Medium Thd, 7.2 x 115mm Sterile
P26-772-120F-S	JOUST™ Beam, Solid, Headless, Full Thd, 7.2 x 120mm Sterile
P26-772-120M-S	JOUST™ Beam, Solid, Headless, Medium Thd, 7.2 x 120mm Sterile
P26-772-125F-S	JOUST™ Beam, Solid, Headless, Full Thd, 7.2 x 125mm Sterile
P26-772-125M-S	JOUST™ Beam, Solid, Headless, Medium Thd, 7.2 x 125mm Sterile
P26-772-130F-S	JOUST™ Beam, Solid, Headless, Full Thd, 7.2 x 130mm Sterile
P26-772-130M-S	JOUST™ Beam, Solid, Headless, Medium Thd, 7.2 x 130mm Sterile
P26-772-135F-S	JOUST™ Beam, Solid, Headless, Full Thd, 7.2 x 135mm Sterile
P26-772-135M-S	JOUST™ Beam, Solid, Headless, Medium Thd, 7.2 x 135mm Sterile
P26-772-140F-S	JOUST™ Beam, Solid, Headless, Full Thd, 7.2 x 140mm Sterile
P26-772-140M-S	JOUST™ Beam, Solid, Headless, Medium Thd, 7.2 x 140mm Sterile
P26-772-145F-S	JOUST™ Beam, Solid, Headless, Full Thd, 7.2 x 145mm Sterile
P26-772-145M-S	JOUST™ Beam, Solid, Headless, Medium Thd, 7.2 x 145mm Sterile
P26-772-150F-S	JOUST™ Beam, Solid, Headless, Full Thd, 7.2 x 150mm Sterile
P26-772-150M-S	JOUST™ Beam, Solid, Headless, Medium Thd, 7.2 x 150mm Sterile
P26-772-155F-S	JOUST™ Beam, Solid, Headless, Full Thd, 7.2 x 155mm Sterile

Not all products available for sale in all markets. To determine availability in your marketplace, please contact your local Paragon 28 representative or email info@paragon28.com.

STERILE PACKAGED PRODUCT

PART NUMBER	DESCRIPTION
P26-772-155M-S	JOUST™ Beam, Solid, Headless, Medium Thd, 7.2 x 155mm Sterile
P26-772-160F-S	JOUST™ Beam, Solid, Headless, Full Thd, 7.2 x 160mm Sterile
P26-772-160M-S	JOUST™ Beam, Solid, Headless, Medium Thd, 7.2 x 160mm Sterile
P26-772-165F-S	JOUST™ Beam, Solid, Headless, Full Thd, 7.2 x 165mm Sterile
P26-772-165M-S	JOUST™ Beam, Solid, Headless, Medium Thd, 7.2 x 165mm Sterile
P26-772-170F-S	JOUST™ Beam, Solid, Headless, Full Thd, 7.2 x 170mm Sterile
P26-772-170M-S	JOUST™ Beam, Solid, Headless, Medium Thd, 7.2 x 170mm Sterile
P26-772-175F-S	JOUST™ Beam, Solid, Headless, Full Thd, 7.2 x 175mm Sterile
P26-772-175M-S	JOUST™ Beam, Solid, Headless, Medium Thd, 7.2 x 175mm Sterile
P26-772-180F-S	JOUST™ Beam, Solid, Headless, Full Thd, 7.2 x 180mm Sterile
P26-772-180M-S	JOUST™ Beam, Solid, Headless, Medium Thd, 7.2 x 180mm Sterile
P26-772-185F-S	JOUST™ Beam, Solid, Headless, Full Thd, 7.2 x 185mm Sterile
P26-772-185M-S	JOUST™ Beam, Solid, Headless, Medium Thd, 7.2 x 185mm Sterile
P40-900-0801-S	HammerToe, Planer, Ø8mm, Cannulated Trocar Insert (AO), SS
P40-920-2107-S	Drill, 2.15mm, Cannulated (Patent Pending)
P40-920-2607-S	Drill, 2.65mm, Cannulated (Patent Pending)
P40-920-2707-S	Drill, 2.75mm, Cannulated (Patent Pending)
P40-920-3507-S	Drill, 3.5mm, Cannulated (Patent Pending)
P50-053-2008-S	Baby Gorilla®, Screw, Ø2.0 x 8mm, Locking, TiA Sterile
P50-053-2009-S	Baby Gorilla®, Screw, Ø2.0 x 9mm, Locking, TiA Sterile
P50-053-2010-S	Baby Gorilla®, Screw, Ø2.0 x 10mm, Locking, TiA Sterile
P50-053-2011-S	Baby Gorilla®, Screw, Ø2.0 x 11mm, Locking, TiA Sterile
P50-053-2012-S	Baby Gorilla®, Screw, Ø2.0 x 12mm, Locking, TiA Sterile
P50-053-2013-S	Baby Gorilla®, Screw, Ø2.0 x 13mm, Locking, TiA Sterile
P50-053-2014-S	Baby Gorilla®, Screw, Ø2.0 x 14mm, Locking, TiA Sterile
P50-053-2015-S	Baby Gorilla®, Screw, Ø2.0 x 15mm, Locking, TiA Sterile
P50-053-2016-S	Baby Gorilla®, Screw, Ø2.0 x 16mm, Locking, TiA Sterile
P50-053-2017-S	Baby Gorilla®, Screw, Ø2.0 x 17mm, Locking, TiA Sterile
P50-053-2018-S	Baby Gorilla®, Screw, Ø2.0 x 18mm, Locking, TiA Sterile
P50-053-2019-S	Baby Gorilla®, Screw, Ø2.0 x 19mm, Locking, TiA Sterile
P50-053-2020-S	Baby Gorilla®, Screw, Ø2.0 x 20mm, Locking, TiA Sterile
P50-053-2022-S	Baby Gorilla®, Screw, Ø2.0 x 22mm, Locking, TiA Sterile
P50-053-2024-S	Baby Gorilla®, Screw, Ø2.0 x 24mm, Locking, TiA Sterile
P50-053-2026-S	Baby Gorilla®, Screw, Ø2.0 x 26mm, Locking, TiA Sterile
P50-053-2028-S	Baby Gorilla®, Screw, Ø2.0 x 28mm, Locking, TiA Sterile
P50-053-2030-S	Baby Gorilla®, Screw, Ø2.0 x 30mm, Locking, TiA Sterile
P50-053-2032-S	Baby Gorilla®, Screw, Ø2.0 x 32mm, Locking, TiA Sterile
P50-053-2034-S	Baby Gorilla®, Screw, Ø2.0 x 34mm, Locking, TiA Sterile
P50-053-2036-S	Baby Gorilla®, Screw, Ø2.0 x 36mm, Locking, TiA Sterile
P50-053-2038-S	Baby Gorilla®, Screw, Ø2.0 x 38mm, Locking, TiA Sterile

Not all products available for sale in all markets. To determine availability in your marketplace, please contact your local Paragon 28 representative or email info@paragon28.com.

STERILE PACKAGED PRODUCT

PART NUMBER	DESCRIPTION
P50-053-2040-S	Baby Gorilla®, Screw, Ø2.0 x 40mm, Locking, TiA Sterile
P50-053-2508-S	Baby Gorilla®, Screw, Ø2.5 x 8mm, Locking, TiA Sterile
P50-053-2509-S	Baby Gorilla®, Screw, Ø2.5 x 9mm, Locking, TiA Sterile
P50-053-2510-S	Baby Gorilla®, Screw, Ø2.5 x 10mm, Locking, TiA Sterile
P50-053-2511-S	Baby Gorilla®, Screw, Ø2.5 x 11mm, Locking, TiA Sterile
P50-053-2512-S	Baby Gorilla®, Screw, Ø2.5 x 12mm, Locking, TiA Sterile
P50-053-2513-S	Baby Gorilla®, Screw, Ø2.5 x 13mm, Locking, TiA Sterile
P50-053-2514-S	Baby Gorilla®, Screw, Ø2.5 x 14mm, Locking, TiA Sterile
P50-053-2515-S	Baby Gorilla®, Screw, Ø2.5 x 15mm, Locking, TiA Sterile
P50-053-2516-S	Baby Gorilla®, Screw, Ø2.5 x 16mm, Locking, TiA Sterile
P50-053-2517-S	Baby Gorilla®, Screw, Ø2.5 x 17mm, Locking, TiA Sterile
P50-053-2518-S	Baby Gorilla®, Screw, Ø2.5 x 18mm, Locking, TiA Sterile
P50-053-2519-S	Baby Gorilla®, Screw, Ø2.5 x 19mm, Locking, TiA Sterile
P50-053-2520-S	Baby Gorilla®, Screw, Ø2.5 x 20mm, Locking, TiA Sterile
P50-053-2522-S	Baby Gorilla®, Screw, Ø2.5 x 22mm, Locking, TiA Sterile
P50-053-2524-S	Baby Gorilla®, Screw, Ø2.5 x 24mm, Locking, TiA Sterile
P50-053-2526-S	Baby Gorilla®, Screw, Ø2.5 x 26mm, Locking, TiA Sterile
P50-053-2528-S	Baby Gorilla®, Screw, Ø2.5 x 28mm, Locking, TiA Sterile
P50-053-2530-S	Baby Gorilla®, Screw, Ø2.5 x 30mm, Locking, TiA Sterile
P50-053-2532-S	Baby Gorilla®, Screw, Ø2.5 x 32mm, Locking, TiA Sterile
P50-053-2534-S	Baby Gorilla®, Screw, Ø2.5 x 34mm, Locking, TiA Sterile
P50-053-2536-S	Baby Gorilla®, Screw, Ø2.5 x 36mm, Locking, TiA Sterile
P50-053-2538-S	Baby Gorilla®, Screw, Ø2.5 x 38mm, Locking, TiA Sterile
P50-053-2540-S	Baby Gorilla®, Screw, Ø2.5 x 40mm, Locking, TiA Sterile
P50-053-2545-S	Baby Gorilla®, Screw, Ø2.5 x 45mm, Locking, TiA Sterile
P50-053-2550-S	Baby Gorilla®, Screw, Ø2.5 x 50mm, Locking, TiA Sterile
P50-153-2008-S	Baby Gorilla®, Screw, Ø2.0 x 8mm, Non-Locking, TiA Sterile
P50-153-2009-S	Baby Gorilla®, Screw, Ø2.0 x 9mm, Non-Locking, TiA Sterile
P50-153-2010-S	Baby Gorilla®, Screw, Ø2.0 x 10mm, Non-Locking, TiA Sterile
P50-153-2011-S	Baby Gorilla®, Screw, Ø2.0 x 11mm, Non-Locking, TiA Sterile
P50-153-2012-S	Baby Gorilla®, Screw, Ø2.0 x 12mm, Non-Locking, TiA Sterile
P50-153-2013-S	Baby Gorilla®, Screw, Ø2.0 x 13mm, Non-Locking, TiA Sterile
P50-153-2014-S	Baby Gorilla®, Screw, Ø2.0 x 14mm, Non-Locking, TiA Sterile
P50-153-2015-S	Baby Gorilla®, Screw, Ø2.0 x 15mm, Non-Locking, TiA Sterile
P50-153-2016-S	Baby Gorilla®, Screw, Ø2.0 x 16mm, Non-Locking, TiA Sterile
P50-153-2017-S	Baby Gorilla®, Screw, Ø2.0 x 17mm, Non-Locking, TiA Sterile
P50-153-2018-S	Baby Gorilla®, Screw, Ø2.0 x 18mm, Non-Locking, TiA Sterile
P50-153-2019-S	Baby Gorilla®, Screw, Ø2.0 x 19mm, Non-Locking, TiA Sterile
P50-153-2020-S	Baby Gorilla®, Screw, Ø2.0 x 20mm, Non-Locking, TiA Sterile
P50-153-2022-S	Baby Gorilla®, Screw, Ø2.0 x 22mm, Non-Locking, TiA Sterile

Not all products available for sale in all markets. To determine availability in your marketplace, please contact your local Paragon 28 representative or email info@paragon28.com.

STERILE PACKAGED PRODUCT

PART NUMBER	DESCRIPTION
P50-153-2024-S	Baby Gorilla®, Screw, Ø2.0 x 24mm, Non-Locking, TiA Sterile
P50-153-2026-S	Baby Gorilla®, Screw, Ø2.0 x 26mm, Non-Locking, TiA Sterile
P50-153-2028-S	Baby Gorilla®, Screw, Ø2.0 x 28mm, Non-Locking, TiA Sterile
P50-153-2030-S	Baby Gorilla®, Screw, Ø2.0 x 30mm, Non-Locking, TiA Sterile
P50-153-2032-S	Baby Gorilla®, Screw, Ø2.0 x 32mm, Non-Locking, TiA Sterile
P50-153-2034-S	Baby Gorilla®, Screw, Ø2.0 x 34mm, Non-Locking, TiA Sterile
P50-153-2036-S	Baby Gorilla®, Screw, Ø2.0 x 36mm, Non-Locking, TiA Sterile
P50-153-2038-S	Baby Gorilla®, Screw, Ø2.0 x 38mm, Non-Locking, TiA Sterile
P50-153-2040-S	Baby Gorilla®, Screw, Ø2.0 x 40mm, Non-Locking, TiA Sterile
P50-153-2508-S	Baby Gorilla®, Screw, Ø2.5 x 8mm, Non-Locking, TiA Sterile
P50-153-2509-S	Baby Gorilla®, Screw, Ø2.5 x 9mm, Non-Locking, TiA Sterile
P50-153-2510-S	Baby Gorilla®, Screw, Ø2.5 x 10mm, Non-Locking, TiA Sterile
P50-153-2511-S	Baby Gorilla®, Screw, Ø2.5 x 11mm, Non-Locking, TiA Sterile
P50-153-2512-S	Baby Gorilla®, Screw, Ø2.5 x 12mm, Non-Locking, TiA Sterile
P50-153-2513-S	Baby Gorilla®, Screw, Ø2.5 x 13mm, Non-Locking, TiA Sterile
P50-153-2514-S	Baby Gorilla®, Screw, Ø2.5 x 14mm, Non-Locking, TiA Sterile
P50-153-2515-S	Baby Gorilla®, Screw, Ø2.5 x 15mm, Non-Locking, TiA Sterile
P50-153-2516-S	Baby Gorilla®, Screw, Ø2.5 x 16mm, Non-Locking, TiA Sterile
P50-153-2517-S	Baby Gorilla®, Screw, Ø2.5 x 17mm, Non-Locking, TiA Sterile
P50-153-2518-S	Baby Gorilla®, Screw, Ø2.5 x 18mm, Non-Locking, TiA Sterile
P50-153-2519-S	Baby Gorilla®, Screw, Ø2.5 x 19mm, Non-Locking, TiA Sterile
P50-153-2520-S	Baby Gorilla®, Screw, Ø2.5 x 20mm, Non-Locking, TiA Sterile
P50-153-2522-S	Baby Gorilla®, Screw, Ø2.5 x 22mm, Non-Locking, TiA Sterile
P50-153-2524-S	Baby Gorilla®, Screw, Ø2.5 x 24mm, Non-Locking, TiA Sterile
P50-153-2526-S	Baby Gorilla®, Screw, Ø2.5 x 26mm, Non-Locking, TiA Sterile
P50-153-2528-S	Baby Gorilla®, Screw, Ø2.5 x 28mm, Non-Locking, TiA Sterile
P50-153-2530-S	Baby Gorilla®, Screw, Ø2.5 x 30mm, Non-Locking, TiA Sterile
P50-153-2532-S	Baby Gorilla®, Screw, Ø2.5 x 32mm, Non-Locking, TiA Sterile
P50-153-2534-S	Baby Gorilla®, Screw, Ø2.5 x 34mm, Non-Locking, TiA Sterile
P50-153-2536-S	Baby Gorilla®, Screw, Ø2.5 x 36mm, Non-Locking, TiA Sterile
P50-153-2538-S	Baby Gorilla®, Screw, Ø2.5 x 38mm, Non-Locking, TiA Sterile
P50-153-2540-S	Baby Gorilla®, Screw, Ø2.5 x 40mm, Non-Locking, TiA Sterile
P50-153-2545-S	Baby Gorilla®, Screw, Ø2.5 x 45mm, Non-Locking, TiA Sterile
P50-153-2550-S	Baby Gorilla®, Screw, Ø2.5 x 50mm, Non-Locking, TiA Sterile
P50-153-WM00-S	Baby Gorilla®, Washer Sterile
P50-153-WS00-S	Gorilla® R3CON Washer, Flat/Dome Screw, Ø2.7, Ø3.5 & Ø4.2 Sterile
P50-353-2708-S	Gorilla® R3CON Locking Screw, Ø2.7 x 8mm Sterile
P50-353-2709-S	Gorilla® R3CON Locking Screw, Ø2.7 x 9mm Sterile
P50-353-2710-S	Gorilla® R3CON Locking Screw, Ø2.7 x 10mm Sterile
P50-353-2711-S	Gorilla® R3CON Locking Screw, Ø2.7 x 11mm Sterile

Not all products available for sale in all markets. To determine availability in your marketplace, please contact your local Paragon 28 representative or email info@paragon28.com.

STERILE PACKAGED PRODUCT

PART NUMBER	DESCRIPTION
P50-353-2712-S	Gorilla® R3CON Locking Screw, Ø2.7 x 12mm Sterile
P50-353-2713-S	Gorilla® R3CON Locking Screw, Ø2.7 x 13mm Sterile
P50-353-2714-S	Gorilla® R3CON Locking Screw, Ø2.7 x 14mm Sterile
P50-353-2715-S	Gorilla® R3CON Locking Screw, Ø2.7 x 15mm Sterile
P50-353-2716-S	Gorilla® R3CON Locking Screw, Ø2.7 x 16mm Sterile
P50-353-2717-S	Gorilla® R3CON Locking Screw, Ø2.7 x 17mm Sterile
P50-353-2718-S	Gorilla® R3CON Locking Screw, Ø2.7 x 18mm Sterile
P50-353-2719-S	Gorilla® R3CON Locking Screw, Ø2.7 x 19mm Sterile
P50-353-2720-S	Gorilla® R3CON Locking Screw, Ø2.7 x 20mm Sterile
P50-353-2722-S	Gorilla® R3CON Locking Screw, Ø2.7 x 22mm Sterile
P50-353-2724-S	Gorilla® R3CON Locking Screw, Ø2.7 x 24mm Sterile
P50-353-2726-S	Gorilla® R3CON Locking Screw, Ø2.7 x 26mm Sterile
P50-353-2728-S	Gorilla® R3CON Locking Screw, Ø2.7 x 28mm Sterile
P50-353-2730-S	Gorilla® R3CON Locking Screw, Ø2.7 x 30mm Sterile
P50-353-2732-S	Gorilla® R3CON Locking Screw, Ø2.7 x 32mm Sterile
P50-353-2734-S	Gorilla® R3CON Locking Screw, Ø2.7 x 34mm Sterile
P50-353-2736-S	Gorilla® R3CON Locking Screw, Ø2.7 x 36mm Sterile
P50-353-2738-S	Gorilla® R3CON Locking Screw, Ø2.7 x 38mm Sterile
P50-353-2740-S	Gorilla® R3CON Locking Screw, Ø2.7 x 40mm Sterile
P50-353-3510-S	Gorilla® R3CON Locking Screw, Ø3.5 x 10mm Sterile
P50-353-3512-S	Gorilla® R3CON Locking Screw, Ø3.5 x 12mm Sterile
P50-353-3514-S	Gorilla® R3CON Locking Screw, Ø3.5 x 14mm Sterile
P50-353-3516-S	Gorilla® R3CON Locking Screw, Ø3.5 x 16mm Sterile
P50-353-3518-S	Gorilla® R3CON Locking Screw, Ø3.5 x 18mm Sterile
P50-353-3520-S	Gorilla® R3CON Locking Screw, Ø3.5 x 20mm Sterile
P50-353-3522-S	Gorilla® R3CON Locking Screw, Ø3.5 x 22mm Sterile
P50-353-3524-S	Gorilla® R3CON Locking Screw, Ø3.5 x 24mm Sterile
P50-353-3526-S	Gorilla® R3CON Locking Screw, Ø3.5 x 26mm Sterile
P50-353-3528-S	Gorilla® R3CON Locking Screw, Ø3.5 x 28mm Sterile
P50-353-3530-S	Gorilla® R3CON Locking Screw, Ø3.5 x 30mm Sterile
P50-353-3532-S	Gorilla® R3CON Locking Screw, Ø3.5 x 32mm Sterile
P50-353-3534-S	Gorilla® R3CON Locking Screw, Ø3.5 x 34mm Sterile
P50-353-3536-S	Gorilla® R3CON Locking Screw, Ø3.5 x 36mm Sterile
P50-353-3538-S	Gorilla® R3CON Locking Screw, Ø3.5 x 38mm Sterile
P50-353-3540-S	Gorilla® R3CON Locking Screw, Ø3.5 x 40mm Sterile
P50-353-3542-S	Gorilla® R3CON Locking Screw, Ø3.5 x 42mm Sterile
P50-353-3544-S	Gorilla® R3CON Locking Screw, Ø3.5 x 44mm Sterile
P50-353-3546-S	Gorilla® R3CON Locking Screw, Ø3.5 x 46mm Sterile
P50-353-3548-S	Gorilla® R3CON Locking Screw, Ø3.5 x 48mm Sterile
P50-353-3550-S	Gorilla® R3CON Locking Screw, Ø3.5 x 50mm Sterile

Not all products available for sale in all markets. To determine availability in your marketplace, please contact your local Paragon 28 representative or email info@paragon28.com.

STERILE PACKAGED PRODUCT

PART NUMBER	DESCRIPTION
P50-353-4210-S	Gorilla® R3CON Locking Screw, Ø4.2 x 10mm Sterile
P50-353-4212-S	Gorilla® R3CON Locking Screw, Ø4.2 x 12mm Sterile
P50-353-4214-S	Gorilla® R3CON Locking Screw, Ø4.2 x 14mm Sterile
P50-353-4216-S	Gorilla® R3CON Locking Screw, Ø4.2 x 16mm Sterile
P50-353-4218-S	Gorilla® R3CON Locking Screw, Ø4.2 x 18mm Sterile
P50-353-4220-S	Gorilla® R3CON Locking Screw, Ø4.2 x 20mm Sterile
P50-353-4222-S	Gorilla® R3CON Locking Screw, Ø4.2 x 22mm Sterile
P50-353-4224-S	Gorilla® R3CON Locking Screw, Ø4.2 x 24mm Sterile
P50-353-4226-S	Gorilla® R3CON Locking Screw, Ø4.2 x 26mm Sterile
P50-353-4228-S	Gorilla® R3CON Locking Screw, Ø4.2 x 28mm Sterile
P50-353-4230-S	Gorilla® R3CON Locking Screw, Ø4.2 x 30mm Sterile
P50-353-4232-S	Gorilla® R3CON Locking Screw, Ø4.2 x 32mm Sterile
P50-353-4234-S	Gorilla® R3CON Locking Screw, Ø4.2 x 34mm Sterile
P50-353-4236-S	Gorilla® R3CON Locking Screw, Ø4.2 x 36mm Sterile
P50-353-4238-S	Gorilla® R3CON Locking Screw, Ø4.2 x 38mm Sterile
P50-353-4240-S	Gorilla® R3CON Locking Screw, Ø4.2 x 40mm Sterile
P50-353-4242-S	Gorilla® R3CON Locking Screw, Ø4.2 x 42mm Sterile
P50-353-4244-S	Gorilla® R3CON Locking Screw, Ø4.2 x 44mm Sterile
P50-353-4246-S	Gorilla® R3CON Locking Screw, Ø4.2 x 46mm Sterile
P50-353-4248-S	Gorilla® R3CON Locking Screw, Ø4.2 x 48mm Sterile
P50-353-4250-S	Gorilla® R3CON Locking Screw, Ø4.2 x 50mm Sterile
P50-353-4255-S	Gorilla® R3CON Locking Screw, Ø4.2 x 55mm Sterile
P50-353-4260-S	Gorilla® R3CON Locking Screw, Ø4.2 x 60mm Sterile
P50-353-4265-S	Gorilla® R3CON Locking Screw, Ø4.2 x 65mm Sterile
P50-353-4270-S	Gorilla® R3CON Locking Screw, Ø4.2 x 70mm Sterile
P50-453-2708-S	Gorilla® R3CON Non-Locking Screw, Ø2.7 x 8mm Sterile
P50-453-2709-S	Gorilla® R3CON Non-Locking Screw, Ø2.7 x 9mm Sterile
P50-453-2710-S	Gorilla® R3CON Non-Locking Screw, Ø2.7 x 10mm Sterile
P50-453-2711-S	Gorilla® R3CON Non-Locking Screw, Ø2.7 x 11mm Sterile
P50-453-2712-S	Gorilla® R3CON Non-Locking Screw, Ø2.7 x 12mm Sterile
P50-453-2713-S	Gorilla® R3CON Non-Locking Screw, Ø2.7 x 13mm Sterile
P50-453-2714-S	Gorilla® R3CON Non-Locking Screw, Ø2.7 x 14mm Sterile
P50-453-2715-S	Gorilla® R3CON Non-Locking Screw, Ø2.7 x 15mm Sterile
P50-453-2716-S	Gorilla® R3CON Non-Locking Screw, Ø2.7 x 16mm Sterile
P50-453-2717-S	Gorilla® R3CON Non-Locking Screw, Ø2.7 x 17mm Sterile
P50-453-2718-S	Gorilla® R3CON Non-Locking Screw, Ø2.7 x 18mm Sterile
P50-453-2719-S	Gorilla® R3CON Non-Locking Screw, Ø2.7 x 19mm Sterile
P50-453-2720-S	Gorilla® R3CON Non-Locking Screw, Ø2.7 x 20mm Sterile
P50-453-2722-S	Gorilla® R3CON Non-Locking Screw, Ø2.7 x 22mm Sterile
P50-453-2724-S	Gorilla® R3CON Non-Locking Screw, Ø2.7 x 24mm Sterile

Not all products available for sale in all markets. To determine availability in your marketplace, please contact your local Paragon 28 representative or email info@paragon28.com.

STERILE PACKAGED PRODUCT

PART NUMBER	DESCRIPTION
P50-453-2726-S	Gorilla® R3CON Non-Locking Screw, Ø2.7 x 26mm Sterile
P50-453-2728-S	Gorilla® R3CON Non-Locking Screw, Ø2.7 x 28mm Sterile
P50-453-2730-S	Gorilla® R3CON Non-Locking Screw, Ø2.7 x 30mm Sterile
P50-453-2732-S	Gorilla® R3CON Non-Locking Screw, Ø2.7 x 32mm Sterile
P50-453-2734-S	Gorilla® R3CON Non-Locking Screw, Ø2.7 x 34mm Sterile
P50-453-2736-S	Gorilla® R3CON Non-Locking Screw, Ø2.7 x 36mm Sterile
P50-453-2738-S	Gorilla® R3CON Non-Locking Screw, Ø2.7 x 38mm Sterile
P50-453-2740-S	Gorilla® R3CON Non-Locking Screw, Ø2.7 x 40mm Sterile
P50-453-3510-S	Gorilla® R3CON Non-Locking Screw, Ø3.5 X 10mm Sterile
P50-453-3512-S	Gorilla® R3CON Non-Locking Screw, Ø3.5 X 12mm Sterile
P50-453-3514-S	Gorilla® R3CON Non-Locking Screw, Ø3.5 X 14mm Sterile
P50-453-3516-S	Gorilla® R3CON Non-Locking Screw, Ø3.5 X 16mm Sterile
P50-453-3518-S	Gorilla® R3CON Non-Locking Screw, Ø3.5 X 18mm Sterile
P50-453-3520-S	Gorilla® R3CON Non-Locking Screw, Ø3.5 X 20mm Sterile
P50-453-3522-S	Gorilla® R3CON Non-Locking Screw, Ø3.5 X 22mm Sterile
P50-453-3524-S	Gorilla® R3CON Non-Locking Screw, Ø3.5 X 24mm Sterile
P50-453-3526-S	Gorilla® R3CON Non-Locking Screw, Ø3.5 X 26mm Sterile
P50-453-3528-S	Gorilla® R3CON Non-Locking Screw, Ø3.5 X 28mm Sterile
P50-453-3530-S	Gorilla® R3CON Non-Locking Screw, Ø3.5 X 30mm Sterile
P50-453-3532-S	Gorilla® R3CON Non-Locking Screw, Ø3.5 X 32mm Sterile
P50-453-3534-S	Gorilla® R3CON Non-Locking Screw, Ø3.5 X 34mm Sterile
P50-453-3536-S	Gorilla® R3CON Non-Locking Screw, Ø3.5 X 36mm Sterile
P50-453-3538-S	Gorilla® R3CON Non-Locking Screw, Ø3.5 X 38mm Sterile
P50-453-3540-S	Gorilla® R3CON Non-Locking Screw, Ø3.5 X 40mm Sterile
P50-453-3542-S	Gorilla® R3CON Non-Locking Screw, Ø3.5 X 42mm Sterile
P50-453-3544-S	Gorilla® R3CON Non-Locking Screw, Ø3.5 X 44mm Sterile
P50-453-3546-S	Gorilla® R3CON Non-Locking Screw, Ø3.5 X 46mm Sterile
P50-453-3548-S	Gorilla® R3CON Non-Locking Screw, Ø3.5 X 48mm Sterile
P50-453-3550-S	Gorilla® R3CON Non-Locking Screw, Ø3.5 X 50mm Sterile
P50-453-4210-S	Gorilla® R3CON Non-Locking Screw, Ø4.2 X 10mm Sterile
P50-453-4212-S	Gorilla® R3CON Non-Locking Screw, Ø4.2 X 12mm Sterile
P50-453-4214-S	Gorilla® R3CON Non-Locking Screw, Ø4.2 X 14mm Sterile
P50-453-4216-S	Gorilla® R3CON Non-Locking Screw, Ø4.2 X 16mm Sterile
P50-453-4218-S	Gorilla® R3CON Non-Locking Screw, Ø4.2 X 18mm Sterile
P50-453-4220-S	Gorilla® R3CON Non-Locking Screw, Ø4.2 X 20mm Sterile
P50-453-4222-S	Gorilla® R3CON Non-Locking Screw, Ø4.2 X 22mm Sterile
P50-453-4224-S	Gorilla® R3CON Non-Locking Screw, Ø4.2 X 24mm Sterile
P50-453-4226-S	Gorilla® R3CON Non-Locking Screw, Ø4.2 X 26mm Sterile
P50-453-4228-S	Gorilla® R3CON Non-Locking Screw, Ø4.2 X 28mm Sterile
P50-453-4230-S	Gorilla® R3CON Non-Locking Screw, Ø4.2 X 30mm Sterile

Not all products available for sale in all markets. To determine availability in your marketplace, please contact your local Paragon 28 representative or email info@paragon28.com.

STERILE PACKAGED PRODUCT

PART NUMBER	DESCRIPTION
P50-453-4232-S	Gorilla® R3CON Non-Locking Screw, Ø4.2 X 32mm Sterile
P50-453-4234-S	Gorilla® R3CON Non-Locking Screw, Ø4.2 X 34mm Sterile
P50-453-4236-S	Gorilla® R3CON Non-Locking Screw, Ø4.2 X 36mm Sterile
P50-453-4238-S	Gorilla® R3CON Non-Locking Screw, Ø4.2 X 38mm Sterile
P50-453-4240-S	Gorilla® R3CON Non-Locking Screw, Ø4.2 X 40mm Sterile
P50-453-4242-S	Gorilla® R3CON Non-Locking Screw, Ø4.2 X 42mm Sterile
P50-453-4244-S	Gorilla® R3CON Non-Locking Screw, Ø4.2 X 44mm Sterile
P50-453-4246-S	Gorilla® R3CON Non-Locking Screw, Ø4.2 X 46mm Sterile
P50-453-4248-S	Gorilla® R3CON Non-Locking Screw, Ø4.2 X 48mm Sterile
P50-453-4250-S	Gorilla® R3CON Non-Locking Screw, Ø4.2 X 50mm Sterile
P50-453-4255-S	Gorilla® R3CON Non-Locking Screw, Ø4.2 X 55mm Sterile
P50-453-4260-S	Gorilla® R3CON Non-Locking Screw, Ø4.2 X 60mm Sterile
P50-453-4265-S	Gorilla® R3CON Non-Locking Screw, Ø4.2 X 65mm Sterile
P50-453-4270-S	Gorilla® R3CON Non-Locking Screw, Ø4.2 X 70mm Sterile
P50-455-080F-S	LCF Beam, 5.5 x 80mm, Solid, Full Thread Sterile
P50-455-080L-S	LCF Beam, 5.5 x 80mm, Solid, Long Thread Sterile
P50-455-085F-S	LCF Beam, 5.5 x 85mm, Solid, Full Thread Sterile
P50-455-085L-S	LCF Beam, 5.5 x 85mm, Solid, Long Thread Sterile
P50-455-090F-S	LCF Beam, 5.5 x 90mm, Solid, Full Thread Sterile
P50-455-090L-S	LCF Beam, 5.5 x 90mm, Solid, Long Thread Sterile
P50-455-095F-S	LCF Beam, 5.5 x 95mm, Solid, Full Thread Sterile
P50-455-095L-S	LCF Beam, 5.5 x 95mm, Solid, Long Thread Sterile
P50-455-100F-S	LCF Beam, 5.5 x 100mm, Solid, Full Thread Sterile
P50-455-100L-S	LCF Beam, 5.5 x 100mm, Solid, Long Thread Sterile
P50-455-105F-S	LCF Beam, 5.5 x 105mm, Solid, Full Thread Sterile
P50-455-105L-S	LCF Beam, 5.5 x 105mm, Solid, Long Thread Sterile
P50-455-110F-S	LCF Beam, 5.5 x 110mm, Solid, Full Thread Sterile
P50-455-110L-S	LCF Beam, 5.5 x 110mm, Solid, Long Thread Sterile
P50-455-115F-S	LCF Beam, 5.5 x 115mm, Solid, Full Thread Sterile
P50-455-115L-S	LCF Beam, 5.5 x 115mm, Solid, Long Thread Sterile
P50-455-120F-S	LCF Beam, 5.5 x 120mm, Solid, Full Thread Sterile
P50-455-120L-S	LCF Beam, 5.5 x 120mm, Solid, Long Thread Sterile
P53-001-0004-S	Baby Gorilla® Straight Plate, 4 Hole Sterile
P53-001-0006-S	Baby Gorilla® Straight Plate, 6 Hole Sterile
P53-001-0008-S	Baby Gorilla® Straight Plate, 8 Hole Sterile
P53-001-0010-S	Baby Gorilla® Straight Plate, 10 Hole Sterile
P53-001-0C04-S	Baby Gorilla® Straight Plate, 4 Hole w/ Compression Sterile
P53-001-0C06-S	Baby Gorilla® Straight Plate, 6 Hole w/ Compression Sterile
P53-001-0C08-S	Baby Gorilla® Straight Plate, 8 Hole w/ Compression Sterile
P53-001-1010-S	Baby Gorilla® Akin Plate, Straight, 10mm Sterile

Not all products available for sale in all markets. To determine availability in your marketplace, please contact your local Paragon 28 representative or email info@paragon28.com.

STERILE PACKAGED PRODUCT

PART NUMBER	DESCRIPTION
P53-001-1C10-S	Baby Gorilla® Akin Plate, w/Compression, 10mm Sterile
P53-001-2010-S	Baby Gorilla® Akin Plate, Medial, Anatomic, 10mm Sterile
P53-001-4020-S	Baby Gorilla® Straight Plate, 20 Hole, 1.4mm Thick Sterile
P53-002-L005-S	Baby Gorilla® Oblique L Plate, 5 Hole, Left Sterile
P53-002-L007-S	Baby Gorilla® Oblique L Plate, 7 Hole, Left Sterile
P53-002-LC05-S	Baby Gorilla® Oblique L Plate, 5 Hole, Compression, Left Sterile
P53-002-LC07-S	Baby Gorilla® Oblique L Plate, 7 Hole, Compression, Left Sterile
P53-002-LC38-S	Baby Gorilla® Oblique L Plate, 8 Hole, Mid-Compression L3, Left Sterile
P53-002-LC83-S	Baby Gorilla® Oblique L Plate, 8 Hole, L-Compression L3, Left Sterile
P53-002-R005-S	Baby Gorilla® Oblique L Plate, 5 Hole, Right Sterile
P53-002-R007-S	Baby Gorilla® Oblique L Plate, 7 Hole, Right Sterile
P53-002-RC05-S	Baby Gorilla® Oblique L Plate, 5 Hole, Compression, Right Sterile
P53-002-RC07-S	Baby Gorilla® Oblique L Plate, 7 Hole, Compression, Right Sterile
P53-002-RC38-S	Baby Gorilla® Oblique L Plate, 8 Hole, Mid-Compression L3, Right Sterile
P53-002-RC83-S	Baby Gorilla® Oblique L Plate, 8 Hole, L-Compression L3, Right Sterile
P53-003-0099-S	Baby Gorilla® L Plate, 17 Hole, L9 Sterile
P53-003-L006-S	Baby Gorilla® L Plate, 6 Hole, L2, Left Sterile
P53-003-L037-S	Baby Gorilla® L Plate, 7 Hole, L3, Left Sterile
P53-003-LC06-S	Baby Gorilla® L Plate, 6 Hole, Compression L2, Left Sterile
P53-003-LC27-S	Baby Gorilla® L Plate, 7 Hole, Compression L2, Left Sterile
P53-003-R006-S	Baby Gorilla® L Plate, 6 Hole, L2, Right Sterile
P53-003-R037-S	Baby Gorilla® L Plate, 7 Hole, L3, Right Sterile
P53-003-RC06-S	Baby Gorilla® L Plate, 6 Hole, Compression L2, Right Sterile
P53-003-RC27-S	Baby Gorilla® L Plate, 7 Hole, Compression L2, Right Sterile
P53-004-L008-S	Baby Gorilla® Oblique T, 8 Hole, T2, Left Sterile
P53-004-LC08-S	Baby Gorilla® Oblique T, 8 Hole, Compression T2, Left Sterile
P53-004-R008-S	Baby Gorilla® Oblique T, 8 Hole, T2, Right Sterile
P53-004-RC08-S	Baby Gorilla® Oblique T, 8 Hole, Compression T2, Right Sterile
P53-005-0008-S	Baby Gorilla® T Plate, 8 Hole Sterile
P53-005-0010-S	Baby Gorilla® T Plate, 10 Hole, T2 Sterile
P53-005-0013-S	Baby Gorilla® T Plate, 13 Hole, T2 Sterile
P53-005-0C08-S	Baby Gorilla® T Plate, 8 Hole, Compression T2 Sterile
P53-005-1010-S	Baby Gorilla® T Plate, 10 Hole, T2, Short Neck Sterile
P53-005-3007-S	Baby Gorilla® T Plate, 7 Hole, T3 Sterile
P53-005-3009-S	Baby Gorilla® T Plate, 9 Hole, T3 Sterile
P53-005-3C07-S	Baby Gorilla® T Plate, 7 Hole, Compression T3 Sterile
P53-005-5010-S	Baby Gorilla® T Plate, 10 Hole, T5 Sterile
P53-005-5016-S	Baby Gorilla® T Plate, 16 Hole, T5, 1.4mm Thick Sterile
P53-006-0323-S	Baby Gorilla® Y Plate, 8 Hole, Dual Y 3-2-3, 1.1mm Thick Sterile
P53-006-0535-S	Baby Gorilla® Y Plate, 13 Hole, Dual Y 5-3-5, 1.4mm Thick Sterile

Not all products available for sale in all markets. To determine availability in your marketplace, please contact your local Paragon 28 representative or email info@paragon28.com.

STERILE PACKAGED PRODUCT

PART NUMBER	DESCRIPTION
P53-006-2666-S	Baby Gorilla® Y Plate, 18 Hole, Dual Y 6-6-6, Wide, 1.4mm Thick Sterile
P53-006-3007-S	Baby Gorilla® Y Plate, 7 Hole, Y3, 1.1mm Thick Sterile
P53-006-3C07-S	Baby Gorilla® Y Plate, 7 Hole, Compression Y3, 1.1mm Thick Sterile
P53-006-5017-S	Baby Gorilla® Y Plate, 17 Hole, Y5, 1.4mm Thick Sterile
P53-006-5C17-S	Baby Gorilla® Y Plate, 17 Hole, Compression Y5, 1.4mm Thick Sterile
P53-007-LC08-S	Baby Gorilla® Jones Plate, Compression, 8 Hole, Left Sterile
P53-007-RC08-S	Baby Gorilla® Jones Plate, Compression, 8 Hole, Right Sterile
P53-008-LC05-S	Baby Gorilla® 5th Met Hook Plate, Compression, 5 Hole, Left Sterile
P53-008-LC06-S	Baby Gorilla® Jones Hook Plate, Compression, 6 Hole, Left Sterile
P53-008-RC05-S	Baby Gorilla® 5th Met Hook Plate, Compression, 5 Hole, Right Sterile
P53-008-RC06-S	Baby Gorilla® Jones Hook Plate, Compression, 6 Hole, Right Sterile
P53-009-L001-S	Baby Gorilla® Navicular Plate, 9 Hole, Medium, Left Sterile
P53-009-L002-S	Baby Gorilla® Navicular Plate, 9 Hole, Large, Left Sterile
P53-009-R001-S	Baby Gorilla® Navicular Plate, 9 Hole, Medium, Right Sterile
P53-009-R002-S	Baby Gorilla® Navicular Plate, 9 Hole, Large, Right Sterile
P53-010-0001-S	Baby Gorilla® Cuboid Plate, 7 Hole, Large Sterile
P53-010-0002-S	Baby Gorilla® Cuboid Plate, 8 Hole, Large Sterile
P53-011-L001-S	Baby Gorilla® Talar Neck Plate, Lateral, Small, Left Sterile
P53-011-L002-S	Baby Gorilla® Talar Neck Plate, Lateral, Medium, Left Sterile
P53-011-L101-S	Baby Gorilla® Talar Neck Plate, Medial, Small, Left Sterile
P53-011-R001-S	Baby Gorilla® Talar Neck Plate, Lateral, Small, Right Sterile
P53-011-R002-S	Baby Gorilla® Talar Neck Plate, Lateral, Medium, Right Sterile
P53-011-R101-S	Baby Gorilla® Talar Neck Plate, Medial, Small, Right Sterile
P53-012-0614-S	Baby Gorilla® Mesh Plate, 84 Hole (6 x14) Sterile
P53-014-L002-S	PROMO Plate Left, Straight, Short Sterile
P53-014-L003-S	PROMO Plate Left, Straight, Long Sterile
P53-014-L021-S	PROMO Plate, Left, Angled, Short Sterile
P53-014-L022-S	PROMO Plate, Left, Angled, Long Sterile
P53-014-R002-S	PROMO Plate Right, Straight, Short Sterile
P53-014-R003-S	PROMO Plate Right, Straight, Long Sterile
P53-014-R021-S	PROMO Plate, Right, Angled, Short Sterile
P53-014-R022-S	PROMO Plate, Right, Angled, Long Sterile
P53-051-0005-S	Baby Gorilla® ZigZag Plate, 5 Hole Sterile
P53-051-0007-S	Baby Gorilla® ZigZag Plate, 7 Hole Sterile
P53-051-0009-S	Baby Gorilla® ZigZag Plate, 9 Hole Sterile
P53-051-0011-S	Baby Gorilla® ZigZag Plate, 11 Hole Sterile
P53-051-1013-S	Baby Gorilla®, Plate, ZigZag, Span, 8 Hole Locking Small Sterile
P53-051-1015-S	Baby Gorilla®, Plate, ZigZag, Span, 8 Hole Locking Medium Sterile
P53-051-1017-S	Baby Gorilla®, Plate, ZigZag, Span, 8 Hole Locking Large Sterile
P53-101-1012-S	Gorilla® 28 Plate, 20 mm, 2-Hole Compression, 1.15mm, Medium Thick Sterile

Not all products available for sale in all markets. To determine availability in your marketplace, please contact your local Paragon 28 representative or email info@paragon28.com.

STERILE PACKAGED PRODUCT

PART NUMBER	DESCRIPTION
P53-101-1021-S	Gorilla® 28 Plate, 15 mm, 2-Hole Compression, Small Sterile
P53-101-1022-S	Gorilla® 28 Plate, 20 mm, 2-Hole Compression 1.5mm Thick, Medium Sterile
P53-101-1023-S	Gorilla® 28 Plate, 25 mm, 2-Hole Compression , Large Sterile
P53-101-2011-S	Gorilla® 28 Plate, 15 mm, 2-Hole Locking 1.15mm Thick, Small Sterile
P53-101-2012-S	Gorilla® 28 Plate, 20 mm, 2-Hole Locking 1.15mm Thick, Medium Sterile
P53-101-2013-S	Gorilla® 28 Plate, 25 mm, 2-Hole Locking 1.15mm Thick, Large Sterile
P53-101-2021-S	Gorilla® 28 Plate, 15 mm, 2-Hole Locking 1.5mm Thick, Small Sterile
P53-101-2022-S	Gorilla® 28 Plate, 20 mm, 2-Hole Locking 1.5mm Thick, Medium Sterile
P53-101-2023-S	Gorilla® 28 Plate, 25 mm, 2-Hole Locking 1.5mm Thick, Large Sterile
P53-101-3011-S	Gorilla® 28 Plate, 25 mm, 3-Hole Compression 1.15mm Thick, Small Sterile
P53-101-3012-S	Gorilla® 28 Plate, 30 mm, 3-Hole Compression 1.15mm Thick, Medium Sterile
P53-101-3021-S	Gorilla® 28 Plate, 25 mm, 3-Hole Compression 1.5mm Thick, Small Sterile
P53-101-3022-S	Gorilla® 28 Plate, 30 mm, 3-Hole Compression 1.5mm Thick, Medium Sterile
P53-101-3023-S	Gorilla® 28 Plate, 35 mm, 3-Hole Compression 1.5mm Thick, Large Sterile
P53-101-4021-S	Gorilla® 28 Plate, 4-Hole Straight w/ Compression 1.2mm Thick Sterile
P53-101-4121-S	Gorilla® 28 Plate, 4-Hole Straight, Locking Sterile
P53-101-5021-S	Gorilla® 28 Plate, 5-Hole Straight w/ Compression Sterile
P53-102-L000-S	Gorilla® Lateral Wall Plate, Left, Extra Small Sterile
P53-102-L001-S	Gorilla® Lateral Wall Plate, Left, Small Sterile
P53-102-L002-S	Gorilla® Lateral Wall Plate, Left, Medium Sterile
P53-102-L003-S	Gorilla® Lateral Wall Plate, Left, Large Sterile
P53-102-L101-S	Gorilla® Sinus Tarsi Support Plate, Left, Small Sterile
P53-102-L102-S	Gorilla® Sinus Tarsi Support Plate, Left, Medium Sterile
P53-102-L103-S	Gorilla® Sinus Tarsi Support Plate, Left, Large Sterile
P53-102-L201-S	Gorilla® Sinus Tarsi Plate, Left, Small Sterile
P53-102-L202-S	Gorilla® Sinus Tarsi Plate, Left, Medium Sterile
P53-102-L203-S	Gorilla® Sinus Tarsi Plate, Left, Large Sterile
P53-102-R000-S	Gorilla® Lateral Wall Plate, Right, Extra Small Sterile
P53-102-R001-S	Gorilla® Lateral Wall Plate, Right, Small Sterile
P53-102-R002-S	Gorilla® Lateral Wall Plate, Right, Medium Sterile
P53-102-R003-S	Gorilla® Lateral Wall Plate, Right, Large Sterile
P53-102-R101-S	Gorilla® Sinus Tarsi Support Plate, Right, Small Sterile
P53-102-R102-S	Gorilla® Sinus Tarsi Support Plate, Right, Medium Sterile
P53-102-R103-S	Gorilla® Sinus Tarsi Support Plate, Right, Large Sterile
P53-102-R201-S	Gorilla® Sinus Tarsi Plate, Right, Small Sterile
P53-102-R202-S	Gorilla® Sinus Tarsi Plate, Right, Medium Sterile
P53-102-R203-S	Gorilla® Sinus Tarsi Plate, Right, Large Sterile
P53-103-L001-S	Gorilla® Plate, MTP, Primary, Left, 0°, Small, TiA Sterile
P53-103-L002-S	Gorilla® Plate, MTP, Primary, Left, 0°, Med, TiA Sterile
P53-103-L003-S	Gorilla® Plate, MTP, Primary, Left, 0°, Large, TiA Sterile

Not all products available for sale in all markets. To determine availability in your marketplace, please contact your local Paragon 28 representative or email info@paragon28.com.

STERILE PACKAGED PRODUCT

PART NUMBER	DESCRIPTION
P53-103-L004-S	Gorilla® Plate, MTP, Short (2 Hole Distal), Left, 0°, Small, TiA Sterile
P53-103-L051-S	Gorilla® Plate, MTP, Primary, Left, 5°, Small, TiA Sterile
P53-103-L052-S	Gorilla® Plate, MTP, Primary, Left, 5°, Med, TiA Sterile
P53-103-L053-S	Gorilla® Plate, MTP, Primary, Left, 5°, Large, TiA Sterile
P53-103-L054-S	Gorilla® Plate, MTP, Short (2 Hole Distal), Left, 5°, Small, TiA Sterile
P53-103-L101-S	Gorilla® Plate, MTP, Primary, Left, 10°, Small, TiA Sterile
P53-103-L102-S	Gorilla® Plate, MTP, Primary, Left, 10°, Med, TiA Sterile
P53-103-L103-S	Gorilla® Plate, MTP, Primary, Left, 10°, Large, TiA Sterile
P53-103-L104-S	Gorilla® Plate, MTP, Short (2 Hole Distal), Left, 10°, Small, TiA Sterile
P53-103-L151-S	Gorilla® Plate, MTP, Revision, Left, 5°, Small, TiA Sterile
P53-103-L152-S	Gorilla® Plate, MTP, Revision, Left, 5°, Med, TiA Sterile
P53-103-L153-S	Gorilla® Plate, MTP, Revision, Left, 5°, Large, TiA Sterile
P53-103-L252-S	Gorilla® Plate, MTP, Graft Spanning, Left, 5°, Med, TiA Sterile
P53-103-R001-S	Gorilla® Plate, MTP, Primary, Right, 0°, Small, TiA Sterile
P53-103-R002-S	Gorilla® Plate, MTP, Primary, Right, 0°, Med, TiA Sterile
P53-103-R003-S	Gorilla® Plate, MTP, Primary, Right, 0°, Large, TiA Sterile
P53-103-R004-S	Gorilla® Plate, MTP, Short (2 Hole Distal), Right, 0°, Small, TiA Sterile
P53-103-R051-S	Gorilla® Plate, MTP, Primary, Right, 5°, Small, TiA Sterile
P53-103-R052-S	Gorilla® Plate, MTP, Primary, Right, 5°, Med, TiA Sterile
P53-103-R053-S	Gorilla® Plate, MTP, Primary, Right, 5°, Large, TiA Sterile
P53-103-R054-S	Gorilla® Plate, MTP, Short (2 Hole Distal), Right, 5°, Small, TiA Sterile
P53-103-R101-S	Gorilla® Plate, MTP, Primary, Right, 10°, Small, TiA Sterile
P53-103-R102-S	Gorilla® Plate, MTP, Primary, Right, 10°, Med, TiA Sterile
P53-103-R103-S	Gorilla® Plate, MTP, Primary, Right, 10°, Large, TiA Sterile
P53-103-R104-S	Gorilla® Plate, MTP, Short (2 Hole Distal), Right, 10°, Small, TiA Sterile
P53-103-R151-S	Gorilla® Plate, MTP, Revision, Right, 5°, Small, TiA Sterile
P53-103-R152-S	Gorilla® Plate, MTP, Revision, Right, 5°, Med, TiA Sterile
P53-103-R153-S	Gorilla® Plate, MTP, Revision, Right, 5°, Large, TiA Sterile
P53-103-R252-S	Gorilla® Plate, MTP, Graft Spanning, Right, 5°, Med, TiA Sterile
P53-104-0000-S	Gorilla® Plate, Bow & Arrow®, Base Wedge, 0.0mm Wedge Sterile
P53-104-0020-S	Gorilla® Plate, Bow & Arrow®, Base Wedge, 2.0mm Wedge Sterile
P53-104-0025-S	Gorilla® Plate, Bow & Arrow®, Base Wedge, 2.5mm Wedge Sterile
P53-104-0030-S	Gorilla® Plate, Bow & Arrow®, Base Wedge, 3.0mm Wedge Sterile
P53-104-0035-S	Gorilla® Plate, Bow & Arrow®, Base Wedge, 3.5mm Wedge Sterile
P53-104-0040-S	Gorilla® Plate, Bow & Arrow®, Base Wedge, 4.0mm Wedge Sterile
P53-104-0045-S	Gorilla® Plate, Bow & Arrow®, Base Wedge, 4.5mm Wedge Sterile
P53-104-0150-S	Gorilla® Plate, Bow & Arrow®, Cotton, 5mm Wedge Sterile
P53-104-0160-S	Gorilla® Plate, Bow & Arrow®, Cotton, 6mm Wedge Sterile
P53-104-0170-S	Gorilla® Plate, Bow & Arrow®, Cotton, 7mm Wedge Sterile
P53-104-0180-S	Gorilla® Plate, Bow & Arrow®, Cotton, 8mm Wedge Sterile

Not all products available for sale in all markets. To determine availability in your marketplace, please contact your local Paragon 28 representative or email info@paragon28.com.

STERILE PACKAGED PRODUCT

PART NUMBER	DESCRIPTION
P53-104-0206-S	Gorilla® Plate, Bow & Arrow®, Evans, 6mm Wedge Sterile
P53-104-0208-S	Gorilla® Plate, Bow & Arrow®, Evans, 8mm Wedge Sterile
P53-104-0210-S	Gorilla® Plate, Bow & Arrow®, Evans, 10mm Wedge Sterile
P53-104-0212-S	Gorilla® Plate, Bow & Arrow®, Evans, 12mm Wedge Sterile
P53-104-1000-S	Bow & Arrow®, BASE, Wedge Plate, 0.0mm, Left Sterile
P53-105-L001-S	Gorilla® HEVans Plate, Small, 16mm, Left Sterile
P53-105-L002-S	Gorilla® HEVans Plate, Medium, 20mm, Left Sterile
P53-105-L003-S	Gorilla® HEVans Plate, Long, 24mm, Left Sterile
P53-105-R001-S	Gorilla® HEVans Plate, Small, 16mm, Right Sterile
P53-105-R002-S	Gorilla® HEVans Plate, Medium, 20mm, Right Sterile
P53-105-R003-S	Gorilla® HEVans Plate, Long, 24mm, Right Sterile
P53-106-L001-S	Gorilla® Plate, Lapidus, 4-hole Standard, Compression, Precision Guide, Left Sterile
P53-106-L002-S	Gorilla® Plate, Lapidus, Graft Span Small (5-8mm), 4-hole, Compression, Precision Guide, Left Sterile
P53-106-L003-S	Gorilla® Plate, Lapidus, Graft Span Medium (10-12mm), 5-hole, Precision Guide, Left Sterile
P53-106-L005-S	Gorilla® Plate, Lapidus, Graft Span Large (14mm), 5-hole, Precision Guide, Left Sterile
P53-106-L101-S	Lapidus, 3-Hole Standard, No Arm, Compression Plate, Lt, Precision® Guide, Left Sterile
P53-106-L201-S	Gorilla® Plate, Lapidus, 1 mm step plate, Compression, Precision Guide, Left Sterile
P53-106-L202-S	Gorilla® Plate, Lapidus, 2 mm step plate, Compression, Precision Guide, Left Sterile
P53-106-L203-S	Gorilla® Plate, Lapidus, 3 mm step plate, Compression, Precision Guide, Left Sterile
P53-106-L204-S	Gorilla® Plate, Lapidus, 4 mm step plate, Compression, Left Sterile
P53-106-L205-S	Gorilla® Plate, Lapidus, 5 mm step plate, Compression, Left Sterile
P53-106-R001-S	Gorilla® Plate, Lapidus, 4-hole Standard, Compression, Precision Guide, Right Sterile
P53-106-R002-S	Gorilla® Plate, Lapidus, Graft Span Small (5-8mm), 4-hole Compression, Precision Guide, Right Sterile
P53-106-R003-S	Gorilla® Plate, Lapidus, Graft Span Medium (10-12mm), 5-hole, Precision Guide, Right Sterile
P53-106-R005-S	Gorilla® Plate, Lapidus, Graft Span Large (14mm), 5-hole, Precision Guide, Right Sterile
P53-106-R101-S	Lapidus, 3-Hole Standard, No Arm, Compression Plate, Lt, Precision® Guide, Right Sterile
P53-106-R201-S	Gorilla® Plate, Lapidus, 1 mm step plate, Compression, Precision Guide, Right Sterile
P53-106-R202-S	Gorilla® Plate, Lapidus, 2 mm step plate, Compression, Precision Guide, Right Sterile
P53-106-R203-S	Gorilla® Plate, Lapidus, 3 mm step plate, Compression, Precision Guide, Right Sterile
P53-106-R204-S	Gorilla® Plate, Lapidus, 4 mm step plate, Right Sterile
P53-106-R205-S	Gorilla® Plate, Lapidus, 5 mm step plate, Right Sterile
P53-107-2015-S	Gorilla® Calc Slide Plate Sterile
P53-109-1009-S	Gorilla® Plate, Medial Column Rescue, 9-hole, 1.5mm Sterile
P53-109-1011-S	Gorilla® Plate, Medial Column Rescue, 11-hole, 1.5mm Sterile
P53-109-1015-S	Gorilla® Plate, Medial Column Rescue, 15-hole, 1.5mm Sterile
P53-109-1109-S	Gorilla® Plate, Medial Column Rescue, 9-hole, 2.0mm Sterile
P53-109-1111-S	Gorilla® Plate, Medial Column Rescue, 11-hole, 2.0mm Sterile
P53-109-1115-S	Gorilla® Plate, Medial Column Rescue, 15-hole, 2.0mm Sterile
P53-109-L001-S	Gorilla® Plate, Medial Column Arch, Left, Small, 1.5mm Sterile
P53-109-L002-S	Gorilla® Plate, Medial Column Arch, Left, Medium, 1.5mm Sterile

Not all products available for sale in all markets. To determine availability in your marketplace, please contact your local Paragon 28 representative or email info@paragon28.com.

STERILE PACKAGED PRODUCT

PART NUMBER	DESCRIPTION
P53-109-L003-S	Gorilla® Plate, Medial Column Arch, Left, Large, 1.5mm Sterile
P53-109-L011-S	Gorilla® Plate, Medial Column Proximal Arch, Left, Small, 1.5mm Sterile
P53-109-L012-S	Gorilla® Plate, Medial Column Proximal Arch, Left, Medium, 1.5mm Sterile
P53-109-L013-S	Gorilla® Plate, Medial Column Proximal Arch, Left, Large, 1.5mm Sterile
P53-109-L101-S	Gorilla® Plate, Medial Column Arch, Left, Small, 2.0mm Sterile
P53-109-L102-S	Gorilla® Plate, Medial Column Arch, Left, Medium, 2.0mm Sterile
P53-109-L103-S	Gorilla® Plate, Medial Column Arch, Left, Large, 2.0mm Sterile
P53-109-L111-S	Gorilla® Plate, Medial Column Distal Arch, Left, Small, 2.0mm Sterile
P53-109-L112-S	Gorilla® Plate, Medial Column Distal Arch, Left, Medium, 2.0mm Sterile
P53-109-L113-S	Gorilla® Plate, Medial Column Distal Arch, Left, Large, 2.0mm Sterile
P53-109-L151-S	Gorilla® Medial Column Extended Arch Plate, 2.0mm Thickness, Left, Small Sterile
P53-109-L152-S	Gorilla® Medial Column Extended Arch Plate, 2.0mm Thickness, Left, Medium Sterile
P53-109-L153-S	Gorilla® Medial Column Extended Arch Plate, 2.0mm Thickness, Left, Large Sterile
P53-109-L210-S	Gorilla® Grip™ Plate, 2.0mm Thickness, Left, Xsmall Sterile
P53-109-L211-S	Gorilla® Grip™ Plate, 2.0mm Thickness, Left, Small Sterile
P53-109-L212-S	Gorilla® Grip™ Plate, 2.0mm Thickness, Left, Medium Sterile
P53-109-L213-S	Gorilla® Grip™ Plate, 2.0mm Thickness, Left, Large Sterile
P53-109-L214-S	Gorilla® Grip™ Plate, 2.0mm Thickness, Left, X-Large Sterile
P53-109-L301-S	Gorilla® NC Fusion Plate, 1.5mm Thickness, Left, Small Sterile
P53-109-L302-S	Gorilla® NC Fusion Plate, 1.5mm Thickness, Left, Medium Sterile
P53-109-L303-S	Gorilla® NC Fusion Plate, 1.5mm Thickness, Left, Large Sterile
P53-109-L304-S	Gorilla® NC Fusion Plate, 1.5mm Thickness, Left, X-Large Sterile
P53-109-R001-S	Gorilla® Plate, Medial Column Arch, Right, Small, 1.5mm Sterile
P53-109-R002-S	Gorilla® Plate, Medial Column Arch, Right, Medium, 1.5mm Sterile
P53-109-R003-S	Gorilla® Plate, Medial Column Arch, Right, Large, 1.5mm Sterile
P53-109-R011-S	Gorilla® Plate, Medial Column Proximal Arch, Right, Small, 1.5mm Sterile
P53-109-R012-S	Gorilla® Plate, Medial Column Proximal Arch, Right, Medium, 1.5mm Sterile
P53-109-R013-S	Gorilla® Plate, Medial Column Proximal Arch, Right, Large, 1.5mm Sterile
P53-109-R101-S	Gorilla® Plate, Medial Column Arch, Right, Small, 2.0mm Sterile
P53-109-R102-S	Gorilla® Plate, Medial Column Arch, Right, Medium, 2.0mm Sterile
P53-109-R103-S	Gorilla® Plate, Medial Column Arch, Right, Large, 2.0mm Sterile
P53-109-R111-S	Gorilla® Plate, Medial Column Distal Arch, Right, Small, 2.0mm Sterile
P53-109-R112-S	Gorilla® Plate, Medial Column Distal Arch, Right, Medium, 2.0mm Sterile
P53-109-R113-S	Gorilla® Plate, Medial Column Distal Arch, Right, Large, 2.0mm Sterile
P53-109-R151-S	Gorilla® Medial Column Extended Arch Plate, 2.0mm Thickness, Right, Small Sterile
P53-109-R152-S	Gorilla® Medial Column Extended Arch Plate, 2.0mm Thickness, Right, Medium Sterile
P53-109-R153-S	Gorilla® Medial Column Extended Arch Plate, 2.0mm Thickness, Right, Large Sterile
P53-109-R210-S	Gorilla® Grip™ Plate, 2.0mm Thickness, Right, Xsmall Sterile
P53-109-R211-S	Gorilla® Grip™ Plate, 2.0mm Thickness, Right, Small Sterile
P53-109-R212-S	Gorilla® Grip™ Plate, 2.0mm Thickness, Right, Medium Sterile

Not all products available for sale in all markets. To determine availability in your marketplace, please contact your local Paragon 28 representative or email info@paragon28.com.

STERILE PACKAGED PRODUCT

PART NUMBER	DESCRIPTION
P53-109-R213-S	Gorilla® Grip™ Plate, 2.0mm Thickness, Right, Large Sterile
P53-109-R214-S	Gorilla® Grip™ Plate, 2.0mm Thickness, Right, X-Large Sterile
P53-109-R301-S	Gorilla® NC Fusion Plate, 1.5mm Thickness, Right, Small Sterile
P53-109-R302-S	Gorilla® NC Fusion Plate, 1.5mm Thickness, Right, Medium Sterile
P53-109-R303-S	Gorilla® NC Fusion Plate, 1.5mm Thickness, Right, Large Sterile
P53-109-R304-S	Gorilla® NC Fusion Plate, 1.5mm Thickness, Right, X-Large Sterile
P53-110-L000-S	Gorilla® Plate, Lisfranc, Slanted T, 3 Hole, Compression, Left Sterile
P53-110-L001-S	Gorilla® Plate, Lisfranc, Slanted T, 4 Hole, Compression, Left Sterile
P53-110-L002-S	Gorilla® Plate, Lisfranc, Slanted T, 5 Hole, Compression, Left Sterile
P53-110-L003-S	Gorilla® Plate, Lisfranc, Slanted T, 6 Hole, Compression, Left Sterile
P53-110-L100-S	Gorilla® Plate, Lisfranc, Slanted Straight, 3 Hole Plate, Left Sterile
P53-110-L101-S	Gorilla® Plate, Lisfranc, Slanted Straight, 4 Hole Plate, Left Sterile
P53-110-L102-S	Gorilla® Plate, Lisfranc, Slanted Straight, 5 Hole Plate, Left Sterile
P53-110-L103-S	Gorilla® Plate, Lisfranc, Slanted Straight, 6 Hole Plate, Left Sterile
P53-110-L201-S	Gorilla® Plate, Lisfranc, Dual Ray, 1st & 2nd TMT, Left, Small Sterile
P53-110-L202-S	Gorilla® Plate, Lisfranc, Dual Ray, 1st & 2nd TMT, Left, Medium Sterile
P53-110-L203-S	Gorilla® Plate, Lisfranc, Dual Ray, 1st & 2nd TMT, Left, Large Sterile
P53-110-L211-S	Gorilla® Plate, Lisfranc, Dual Ray, 2nd & 3rd TMT, Left, Small Sterile
P53-110-L212-S	Gorilla® Plate, Lisfranc, Dual Ray, 2nd & 3rd TMT, Left, Medium Sterile
P53-110-L213-S	Gorilla® Plate, Lisfranc, Dual Ray, 2nd & 3rd TMT, Left, Large Sterile
P53-110-L221-S	Gorilla® Lisfranc, Slanted Dual Ray, 2nd & 3rd TMT Plate, Left, Small Sterile
P53-110-L222-S	Gorilla® Lisfranc, Slanted Dual Ray, 2nd & 3rd TMT Plate, Left, Medium Sterile
P53-110-L300-S	Gorilla® Plate, Lisfranc, 4 Hole Clover, Left, Compression Sterile
P53-110-L301-S	Gorilla® Plate, Lisfranc, 5 Hole Clover, Left, Compression Sterile
P53-110-L302-S	Gorilla® Plate, Lisfranc, 6 Hole Clover, Left, Compression Sterile
P53-110-R000-S	Gorilla® Plate, Lisfranc, Slanted T, 3 Hole, Compression, Right Sterile
P53-110-R001-S	Gorilla® Plate, Lisfranc, Slanted T, 4 Hole, Compression, Right Sterile
P53-110-R002-S	Gorilla® Plate, Lisfranc, Slanted T, 5 Hole, Compression, Right Sterile
P53-110-R003-S	Gorilla® Plate, Lisfranc, Slanted T, 6 Hole, Compression, Right Sterile
P53-110-R100-S	Gorilla® Plate, Lisfranc, Slanted Straight, 3 Hole, Right, Slant Sterile
P53-110-R101-S	Gorilla® Plate, Lisfranc, Slanted Straight, 4 Hole, Right, Slant Sterile
P53-110-R102-S	Gorilla® Plate, Lisfranc, Slanted Straight, 5 Hole, Right, Slant Sterile
P53-110-R103-S	Gorilla® Plate, Lisfranc, Slanted Straight, 6 Hole, Right, Slant Sterile
P53-110-R201-S	Gorilla® Plate, Lisfranc, Dual Ray, 1st & 2nd TMT, Right, Small Sterile
P53-110-R202-S	Gorilla® Plate, Lisfranc, Dual Ray, 1st & 2nd TMT, Right, Medium Sterile
P53-110-R203-S	Gorilla® Plate, Lisfranc, Dual Ray, 1st & 2nd TMT, Right, Large Sterile
P53-110-R211-S	Gorilla® Plate, Lisfranc, Dual Ray, 2nd & 3rd TMT, Right, Small Sterile
P53-110-R212-S	Gorilla® Plate, Lisfranc, Dual Ray, 2nd & 3rd TMT, Right, Medium Sterile
P53-110-R213-S	Gorilla® Plate, Lisfranc, Dual Ray, 2nd & 3rd TMT, Right, Large Sterile
P53-110-R221-S	Gorilla® Lisfranc, Slanted Dual Ray, 2nd & 3rd TMT Plate, Right, Small Sterile

Not all products available for sale in all markets. To determine availability in your marketplace, please contact your local Paragon 28 representative or email info@paragon28.com.

STERILE PACKAGED PRODUCT

PART NUMBER	DESCRIPTION
P53-110-R222-S	Gorilla® Lisfranc, Slanted Dual Ray, 2nd & 3rd TMT Plate, Right, Medium Sterile
P53-110-R300-S	Gorilla® Plate, Lisfranc, 4 Hole Clover, Right, Compression Sterile
P53-110-R301-S	Gorilla® Plate, Lisfranc, 5 Hole Clover, Right, Compression Sterile
P53-110-R302-S	Gorilla® Plate, Lisfranc, 6 Hole Clover, Right, Compression Sterile
P53-111-L001-S	Gorilla® LCF Plate, Left, Medium Sterile
P53-111-L002-S	Gorilla® LCF Plate, Left, Large Sterile
P53-111-L101-S	Gorilla® LCF Plate, Left, Medium, w/o Recession Sterile
P53-111-L102-S	Gorilla® LCF Plate, Left, Large, w/o Recession Sterile
P53-111-R001-S	Gorilla® LCF Plate, Right, Medium Sterile
P53-111-R002-S	Gorilla® LCF Plate, Right, Large Sterile
P53-111-R101-S	Gorilla® LCF Plate, Right, Medium, w/o Recession Sterile
P53-111-R102-S	Gorilla® LCF Plate, Right, Large, w/o Recession Sterile
P53-151-0001-S	Gorilla® 10 mm Dogbone Plate Sterile
P53-151-0002-S	Gorilla® 15 mm Dogbone Plate Sterile
P53-151-0003-S	Gorilla® 20 mm Dogbone Plate w/ Compression Sterile
P53-151-0004-S	Gorilla® 25 mm Dogbone Plate w/ Compression Sterile
P53-151-0005-S	Gorilla® 30 mm Dogbone Plate w/ Compression Sterile
P53-151-1002-S	Gorilla® Universal Plate Dog Bone, Slanted, 15mm Sterile
P53-151-1003-S	Gorilla® Universal Plate Dog Bone, Slanted, 20mm Sterile
P53-151-1004-S	Gorilla® Universal Plate Dog Bone, Slanted, 25mm w/ Compression Sterile
P53-151-2002-S	Dogbone™ Plate, 15mm Reverse Slanted, Right Sterile
P53-151-2003-S	Dogbone™ Plate, 20mm Reverse Slanted, Right Sterile
P53-151-2004-S	Dogbone™ Plate, Compression, 25mm Reverse Slanted, Right Sterile
P53-151-5001-S	Dogbone™ Plate, Compression, Small, Slanted, Right Sterile
P53-151-5002-S	Dogbone™ Plate, Compression, Medium, Slanted, Right Sterile
P53-151-5101-S	Dogbone™ Plate, Compression, Small, Slanted, Left Sterile
P53-151-5102-S	Dogbone™ Plate, Compression, Medium, Slanted, Left Sterile
P53-152-0000-S	Gorilla® 3-Hole T-Plate w/ Compression Sterile
P53-152-0001-S	Gorilla® 4-Hole T-Plate w/ Compression Sterile
P53-152-0002-S	Gorilla® 5-Hole T-Plate w/ Compression Sterile
P53-153-0001-S	Gorilla® Trap Plate, Small Sterile
P53-153-0002-S	Gorilla® Trap Plate, Medium Sterile
P53-153-0003-S	Gorilla® Trap Plate, Long Sterile
P53-153-0004-S	Gorilla® Trap Plate, X-Long Sterile
P53-154-0001-S	Gorilla® Teddy Bear Plate, Small Sterile
P53-154-0002-S	Gorilla® Teddy Bear Plate, Medium Sterile
P53-154-0003-S	Gorilla® Teddy Bear Plate, Large Sterile
P53-201-0003-S	Gorilla® Fibular Plate, Straight, 3 Hole Sterile
P53-201-0004-S	Gorilla® Fibular Plate, Straight, 4 Hole Sterile
P53-201-0005-S	Gorilla® Fibular Plate, Straight, 5 Hole Sterile

Not all products available for sale in all markets. To determine availability in your marketplace, please contact your local Paragon 28 representative or email info@paragon28.com.

STERILE PACKAGED PRODUCT

PART NUMBER	DESCRIPTION
P53-201-0006-S	Gorilla® Fibular Plate, Straight, 6 Hole Sterile
P53-201-0007-S	Gorilla® Fibular Plate, Straight, 7 Hole Sterile
P53-201-0008-S	Gorilla® Fibular Plate, Straight, 8 Hole Sterile
P53-201-0009-S	Gorilla® Fibular Plate, Straight, 9 Hole Sterile
P53-201-0010-S	Gorilla® Fibular Plate, Straight, 10 Hole Sterile
P53-201-0012-S	Gorilla® Fibular Plate, Straight, 12 Hole Sterile
P53-201-0014-S	Gorilla® Fibular Plate, Straight, 14 Hole Sterile
P53-201-0016-S	Gorilla® Fibular Plate, Straight, 16 Hole Sterile
P53-203-L007-S	Gorilla® Fibular Plate, Cluster, 7-Hole, Anatomical, Left Sterile
P53-203-L009-S	Gorilla® Fibular Plate, Cluster, 9-Hole, Anatomical, Left Sterile
P53-203-L011-S	Gorilla® Fibular Plate, Cluster, 11-Hole, Anatomical, Left Sterile
P53-203-L013-S	Gorilla® Fibular Plate, Cluster, 13-Hole, Anatomical, Left Sterile
P53-203-L015-S	Gorilla® Fibular Plate, Cluster, 15-Hole, Anatomical, Left Sterile
P53-203-L017-S	Gorilla® Fibular Plate, Cluster, 17-Hole, Anatomical, Left Sterile
P53-203-R007-S	Gorilla® Fibular Plate, Cluster, 7-Hole, Anatomical, Right Sterile
P53-203-R009-S	Gorilla® Fibular Plate, Cluster, 9-Hole, Anatomical, Right Sterile
P53-203-R011-S	Gorilla® Fibular Plate, Cluster, 11-Hole, Anatomical, Right Sterile
P53-203-R013-S	Gorilla® Fibular Plate, Cluster, 13-Hole, Anatomical, Right Sterile
P53-203-R015-S	Gorilla® Fibular Plate, Cluster, 15-Hole, Anatomical, Right Sterile
P53-203-R017-S	Gorilla® Fibular Plate, Cluster, 17-Hole, Anatomical, Right Sterile
P53-204-0005-S	Gorilla® Fibular Plate, Hook, 5-Hole, Anatomical Sterile
P53-204-0006-S	Gorilla® Fibular Plate, Hook, 6-Hole, Anatomical Sterile
P53-205-L005-S	Gorilla® Lateral Malleolus Plate, Hook, 5-Hole Anatomical, Left Sterile
P53-205-L006-S	Gorilla® Lateral Malleolus Plate, Hook, 6-Hole, Anatomical, Left Sterile
P53-205-R005-S	Gorilla® Lateral Malleolus Plate, Hook, 5-Hole, Anatomical, Right Sterile
P53-205-R006-S	Gorilla® Lateral Malleolus Plate, Hook, 6-Hole, Anatomical, Right Sterile
P53-206-0002-S	Gorilla® Medial Malleolus Plate, Hook, 2-Hole, Anatomical Sterile
P53-206-0004-S	Gorilla® Medial Malleolus Plate, Hook, 4-Hole, Anatomical Sterile
P53-207-L005-S	Gorilla® Posterolateral Distal Tibia Plate, 5-Hole, Anatomical, Left Sterile
P53-207-L006-S	Gorilla® Posterolateral Distal Tibia Plate, 6-Hole, Anatomical, Left Sterile
P53-207-L007-S	Gorilla® Posterolateral Distal Tibia Plate, 7-Hole, Anatomical, Left Sterile
P53-207-L008-S	Gorilla® Posterolateral Distal Tibia Plate, 8-Hole, Anatomical, Left Sterile
P53-207-R005-S	Gorilla® Posterolateral Distal Tibia Plate, 5-Hole, Anatomical, Right Sterile
P53-207-R006-S	Gorilla® Posterolateral Distal Tibia Plate, 6-Hole, Anatomical, Right Sterile
P53-207-R007-S	Gorilla® Posterolateral Distal Tibia Plate, 7-Hole, Anatomical, Right Sterile
P53-207-R008-S	Gorilla® Posterolateral Distal Tibia Plate, 8-Hole, Anatomical, Right Sterile
P53-208-0007-S	Gorilla®, Ankle Fx, Posterolateral, Fibula Plate, 07-Hole, Alpha, TiA Sterile
P53-208-0009-S	Gorilla®, Ankle Fx, Posterolateral, Fibula Plate, 09-Hole, w/Comp, Alpha, TiA Sterile
P53-208-0011-S	Gorilla®, Ankle Fx, Posterolateral, Fibula Plate, 11-Hole, w/Comp, Alpha, TiA Sterile
P53-208-1007-S	Gorilla® Posterior, Anti-Glide, Fibular, 7-Hole, Anatomical, Universal L or R Sterile

Not all products available for sale in all markets. To determine availability in your marketplace, please contact your local Paragon 28 representative or email info@paragon28.com.

STERILE PACKAGED PRODUCT

PART NUMBER	DESCRIPTION
P53-208-1009-S	Gorilla® Posterior, Anti-Glide, Fibular, 9-Hole, Anatomical, w/Comp, Universal L or R Sterile
P53-208-1011-S	Gorilla® Posterior, Anti-Glide, Fibular, 11-Hole, Anatomical, w/Comp, Universal L or R Sterile
P53-209-L006-S	Gorilla® Posteromedial Distal Tibia Plate, 6-Hole, Anatomical, Left Sterile
P53-209-L008-S	Gorilla® Posteromedial Distal Tibia Plate, 8-Hole, Anatomical, Left Sterile
P53-209-R006-S	Gorilla® Posteromedial Distal Tibia Plate, 6-Hole, Anatomical, Right Sterile
P53-209-R008-S	Gorilla® Posteromedial Distal Tibia Plate, 8-Hole, Anatomical, Right Sterile
P53-210-0007-S	Gorilla® Medial Malleolus Plate, 7-Hole, Anatomical Sterile
P53-211-0003-S	Gorilla® Posterior Tri-Malleolar Plate, 3-Hole, Anatomical Sterile
P53-211-0004-S	Gorilla® Posterior Tri-Malleolar Plate, 4-Hole, Anatomical Sterile
P80-239-1440-S	R3LEASE® Screw Ø3.9 X 40mm, 14mm Notch, Ti-6Al-4V ELI Sterile
P80-239-1445-S	R3LEASE® Screw Ø3.9 X 45mm, 14mm Notch, Ti-6Al-4V ELI Sterile
P80-239-1450-S	R3LEASE® Screw Ø3.9 X 50mm, 14mm Notch, Ti-6Al-4V ELI Sterile
P80-239-1452-S	R3LEASE® Screw Ø3.9 X 52mm, 14mm Notch, Ti-6Al-4V ELI Sterile
P80-239-1454-S	R3LEASE® Screw Ø3.9 X 54mm, 14mm Notch, Ti-6Al-4V ELI Sterile
P80-239-1456-S	R3LEASE® Screw Ø3.9 X 56mm, 14mm Notch, Ti-6Al-4V ELI Sterile
P80-239-1458-S	R3LEASE® Screw Ø3.9 X 58mm, 14mm Notch, Ti-6Al-4V ELI Sterile
P80-239-1460-S	R3LEASE® Screw Ø3.9 X 60mm, 14mm Notch, Ti-6Al-4V ELI Sterile
P80-239-1462-S	R3LEASE® Screw Ø3.9 X 62mm, 14mm Notch, Ti-6Al-4V ELI Sterile
P80-239-1464-S	R3LEASE® Screw Ø3.9 X 64mm, 14mm Notch, Ti-6Al-4V ELI Sterile
P80-239-1466-S	R3LEASE® Screw Ø3.9 X 66mm, 14mm Notch, Ti-6Al-4V ELI Sterile
P80-239-1740-S	R3LEASE® Screw Ø3.9 X 40mm, 17mm Notch, Ti-6Al-4V ELI Sterile
P80-239-1745-S	R3LEASE® Screw Ø3.9 X 45mm, 17mm Notch, Ti-6Al-4V ELI Sterile
P80-239-1750-S	R3LEASE® Screw Ø3.9 X 50mm, 17mm Notch, Ti-6Al-4V ELI Sterile
P80-239-1752-S	R3LEASE® Screw Ø3.9 X 52mm, 17mm Notch, Ti-6Al-4V ELI Sterile
P80-239-1754-S	R3LEASE® Screw Ø3.9 X 54mm, 17mm Notch, Ti-6Al-4V ELI Sterile
P80-239-1756-S	R3LEASE® Screw Ø3.9 X 56mm, 17mm Notch, Ti-6Al-4V ELI Sterile
P80-239-1758-S	R3LEASE® Screw Ø3.9 X 58mm, 17mm Notch, Ti-6Al-4V ELI Sterile
P80-239-1760-S	R3LEASE® Screw Ø3.9 X 60mm, 17mm Notch, Ti-6Al-4V ELI Sterile
P80-239-1762-S	R3LEASE® Screw Ø3.9 X 62mm, 17mm Notch, Ti-6Al-4V ELI Sterile
P80-239-1764-S	R3LEASE® Screw Ø3.9 X 64mm, 17mm Notch, Ti-6Al-4V ELI Sterile
P80-239-1766-S	R3LEASE® Screw Ø3.9 X 66mm, 17mm Notch, Ti-6Al-4V ELI Sterile
P80-900-2814-S	2.8mm Solid Drill Sterile
P80-910-2814-S	2.8mm Cannulated Drill Sterile
P99-100-1310-S	Drill, 1.3 x 100mm, Solid, AO Sterile
P99-100-1611-S	Drill, 1.6 x 110mm, Solid, AO Sterile
P99-100-1712-S	Drill, 1.7 x 120mm, Solid, Trocar Tip, AO Sterile
P99-100-2009-S	Drill, 2.0 x 85mm, Solid, Refresh, AO Sterile
P99-100-2011-S	Drill, 2.0 x 110mm, Solid, Measuring, AO Sterile
P99-100-2014-S	Drill, 2.0 x 140mm, Solid, Measuring, Long, AO Sterile
P99-100-2109-S	Over Drill, 2.1 x 90mm, Solid, AO Sterile

Not all products available for sale in all markets. To determine availability in your marketplace, please contact your local Paragon 28 representative or email info@paragon28.com.

STERILE PACKAGED PRODUCT

PART NUMBER	DESCRIPTION
P99-100-2312-S	Drill, 2.3 x 120mm, Solid, Trocar Tip, AO Sterile
P99-100-2414-S	Drill, 2.4 x 140mm, Solid, Measuring, Long, AO Sterile
P99-100-2510-S	Over Drill, 2.5 x 100mm, Solid, AO Sterile
P99-100-2613-S	Drill, 2.6 x 130mm, Solid, Trocar Tip, AO Sterile
P99-100-2711-S	Over Drill, 2.7 x 110mm, Solid, AO Sterile
P99-100-2712-S	Over Drill, 2.7 x 120mm, Solid, Trocar Tip, AO Sterile
P99-100-2814-S	Drill, 2.8 x 140mm, Solid, Measuring, Long, AO Sterile
P99-100-3511-S	Over Drill, 3.5 x 110mm, Solid, AO Sterile
P99-100-3811-S	Over Drill, 3.5 x 110mm, Solid, Trocar Tip, AO Sterile
P99-100-4212-S	Over Drill, 4.2 x 120mm, Solid, AO Sterile
P99-100-4312-S	Over Drill, 4.0/4.2 x 120mm, Solid, Trocar Tip, AO Sterile
P99-110-1712-S	Drill, 1.7 x 120mm, Cannulated, AO Sterile
P99-110-2011-S	Over Drill, 2.0 x 110mm, Cannulated, AO Sterile
P99-110-2112-S	Drill, 2.0 x 120mm, Cannulated, AO Sterile
P99-110-2312-S	Drill, 2.3 x 120mm, Cannulated, AO Sterile
P99-110-2511-S	Over Drill, 2.5 x 110mm, Cannulated, AO Sterile
P99-110-2613-S	Drill, 2.6 x 130mm, Cannulated, AO Sterile
P99-110-2815-S	Drill, 2.8 x 150mm, Cannulated, 3/16" Sq. Connection Sterile
P99-110-2914-S	Drill, 2.9 x 140mm, Cannulated, 3/16" Sq. Connection Sterile
P99-110-3011-S	Over Drill, 3.0 x 110mm, Cannulated, AO Sterile
P99-110-3215-S	Drill, 3.2 x 150mm, Cannulated, 3/16" Sq. Connection Sterile
P99-110-3320-S	Drill, 3.3 x 200mm, Cannulated, 3/16 Sq. Connection Sterile
P99-110-3511-S	Over Drill, 3.5 x 110mm, Cannulated, AO Sterile
P99-110-3516-S	Drill, 3.5 x 160mm, Cannulated, 3/16" Sq. Connection Sterile
P99-110-3517-S	Drill, 3.5 x 160mm, Cannulated, AO Sterile
P99-110-3520-S	Drill, 3.5 x 200mm, Cannulated, 3/16 Sq. Connection Sterile
P99-110-3815-S	Drill, 3.8 x 150mm, Cannulated, 3/16" Sq. Connection Sterile
P99-110-4011-S	Over Drill, 4.0 x 110mm, Cannulated, AO Sterile
P99-110-4215-S	Drill, 4.2 x 150mm, Cannulated, 3/16" Sq. Connection Sterile
P99-110-4511-S	Over Drill, 4.5 x 110mm, Cannulated, 3/16" Sq. Connection Sterile
P99-110-4622-S	Drill, 4.6 x 220mm, Cannulated, 3/16" Sq. Connection Sterile
P99-110-4625-S	Drill, 4.6 x 250mm, Standard, Cannulated, 3/16 Sq. Connection Sterile
P99-110-4634-S	Drill, 4.6 x 340mm, Long, Cannulated, 3/16 Sq., SS Sterile
P99-110-5513-S	Over Drill, 5.5 x 130mm, Cannulated, 3/16" Sq. Connection Sterile
P99-110-7020-S	Over Drill, 7.0 x 200mm, Cannulated, 3/16" Sq. Connection Sterile
P99-192-0910-S	K-Wire, Single Ended Trocar Tip, Smooth, Ø0.9 x 100 mm Sterile
P99-192-0915-S	K-Wire, Single Ended Trocar Tip, Smooth, Ø0.9 x 150 mm Sterile
P99-192-1110-S	K-Wire, Single Ended Trocar Tip, Smooth, 1.1 x 100mm Sterile
P99-192-1115-S	K-Wire, Single Ended Trocar Tip, Smooth, Ø1.1 x 150 mm Sterile
P99-192-1210-S	K-Wire, Single Ended Trocar Tip, Smooth, 1.2 x 100mm Sterile

Not all products available for sale in all markets. To determine availability in your marketplace, please contact your local Paragon 28 representative or email info@paragon28.com.

STERILE PACKAGED PRODUCT

PART NUMBER	DESCRIPTION
P99-192-1215-S	K-Wire, Single Ended Trocar Tip, Smooth, Ø1.2 x 150 mm Sterile
P99-192-1410-S	K-Wire, Single Ended Trocar Tip, Smooth, 1.4 x 100mm Sterile
P99-192-1415-S	K-Wire, Single Ended Trocar Tip, Smooth, Ø1.4 x 150 mm Sterile
P99-192-1423-S	K-Wire, Single Ended Trocar Tip, Smooth, 1.4 x 230mm Sterile
P99-192-1610-S	K-Wire, Single Ended Trocar Tip, Smooth, 1.6 x 100 mm Sterile
P99-192-1615-S	K-Wire, Single Ended Trocar Tip, Smooth, Ø1.6 x 150 mm Sterile
P99-192-1620-S	K-Wire, Single Ended Trocar Tip, Smooth, 1.6 x 200mm, LCF Aiming Sterile
P99-192-1623-S	K-Wire, Single Ended Trocar Tip, Smooth, 1.6 x 230mm Sterile
P99-192-2015-S	K-Wire, Single Ended Trocar Tip, Smooth, Ø2.0 x 150 mm Sterile
P99-192-2315-S	K-Wire, Single Ended Trocar Tip, Smooth, Ø2.3 x 150 mm Sterile
P99-192-2320-S	K-Wire, Single Ended Trocar Tip, Smooth, 2.3 x 200mm Sterile
P99-192-2323-S	K-Wire, Single Ended Trocar Tip, Smooth, Ø2.3 x 230 mm Sterile
P99-192-2330-S	K-Wire, Single Ended Trocar Tip, Smooth, 2.3 x 300mm Sterile
P99-192-2515-S	K-Wire, Single Ended Trocar Tip, Smooth, 2.5 x 150mm Sterile
P99-192-2920-S	K-Wire, Single Ended Trocar Tip, Smooth, 2.9 x 200mm Sterile
P99-193-1415-S	K-Wire, Single Ended Trocar Tip, Threaded, Ø1.4 x 150 mm Sterile
P99-193-1423-S	K-Wire, Single Ended Trocar Tip, Threaded, 1.4 x 230mm Sterile
P99-193-1615-S	K-Wire, Single Ended Trocar Tip, Threaded, Ø1.6 x 150 mm Sterile
P99-193-1620-S	K-Wire, Single Ended Trocar Tip, Threaded, 1.6 x 200mm, LCF Aiming Sterile
P99-193-1623-S	K-Wire, Single Ended Trocar Tip, Threaded, 1.6 x 230mm Sterile
P99-193-2323-S	K-Wire, Single Ended Trocar Tip, Threaded, Ø2.3 x 230 mm Sterile
P99-193-2330-S	K-Wire, Single Ended Trocar Tip, Threaded, 2.3 x 300mm Sterile
P99-194-2323-S	K-Wire, Single Ended Trocar Tip, Smooth, w/ FlouroBand, Ø2.3 x 230 mm Sterile
P99-195-2323-S	K-Wire, Single Ended Trocar Tip, Threaded, w/ FlouroBand, Ø2.3 x 230 mm Sterile
P99-192-0910-S-2	K-Wire, 0.9mm, Smooth Trocar, 100mm Sterile Packaged (2 wires)
P99-192-1110-S-2	K-Wire, 1.1mm, Smooth Trocar, 100mm Sterile Packaged (2 wires)
P99-192-1215-S-2	K-Wire, Single Ended Trocar Tip, Smooth, 1.2 X 150 mm Sterile 2 in a pack
P99-192-1215-S-2	K-Wire, Single Ended Trocar Tip, Smooth, 1.2 X 150mm Sterile 2 in a pack
P99-192-1410-S-2	K-Wire, 1.4mm, Smooth Trocar, 100mm Sterile Packaged (2 wires)
P99-192-1415-S-2	1.4 x 150 mm, K-wire, Single Ended Trocar Tip, Smooth Sterile 2 in a pack
P99-192-1615-S-2	1.6 x 150 mm, K-wire, Single Ended Trocar Tip, Smooth Sterile 2 in a pack
P99-192-1620-S-2	P28, K-wire, Single Ended Trocar Tip, SMOOTH, 1.6 x 200 mm, Sterile 2 pack
P99-192-2015-S-2	K-Wire, Single Ended Trocar Tip, Smooth, 2.0 X 150 mm 2 in pack
P99-192-2315-S-2	K-Wire, Single Ended Trocar Tip, Smooth, 2.3 X 150 mm 2 in pack
P99-192-2320-S-2	P28, K-wire, Ø2.3 x 200mm, Smooth, Sterile 2 in pack
P99-192-2323-S-2	2.3 x 230 mm, K-wire, Single Ended Trocar Tip, Smooth Sterile 2 in a pack
P99-192-2515-S-2	K-Wire, Smooth, 2.5 X 150 mm Sterile 2 in a pack
P99-192-2920-S-2	P28, K-wire, Ø2.9 x 200mm, Smooth, Sterile 2 in pack
P99-193-1415-S-2	1.4 x 150 mm, K-wire, Threaded Sterile 2 in a pack
P99-193-1615-S-2	1.6 x 150 mm K-wire, Threaded Sterile 2 in a pack

Not all products available for sale in all markets. To determine availability in your marketplace, please contact your local Paragon 28 representative or email info@paragon28.com.

STERILE PACKAGED PRODUCT

PART NUMBER	DESCRIPTION
P99-193-1620-S-2	P28, K-wire, Single Ended Trocar Tip, THREADED, 1.6 x 200 mm, Sterile 2 pack
P99-200-1406-S-2	Olive Wire, Smooth, 1.4mm (2 pack)
P99-201-1406-S-2	Olive Wire, Threaded, 1.4mm (2 pack)
P99-202-1810-S-2	Olive Wire, Smooth, Short Tip, 1.8mm (2 pack)
P99-250-1608-S-2	ø1.60mm X 8cm Olive Wire, 316 LVM 2 in a pack
P99-250-1610-S-2	ø1.60mm X 10cm Olive Wire, 316 LVM 2 in a pack
P99-292-0910-S-2	K-Wire, 0.9mm, Smooth Double Trocar, 100mm Sterile Packaged (2 wires)
P99-292-1110-S-2	K-Wire, 1.1mm, Smooth Double Trocar, 100mm Sterile Packaged (2 wires)
P99-200-1306-S	Olive Wire, Smooth, 1.3mm Sterile
P99-200-1307-S	Olive Wire, Smooth, 1.3 X 70mm Sterile
P99-200-1406-S	Olive Wire, Smooth, 1.4mm Sterile
P99-201-1306-S	Olive Wire, Threaded, 1.3mm Sterile
P99-201-1307-S	Olive Wire, Threaded, 1.3 X 70mm Sterile
P99-201-1406-S	Olive Wire, Threaded, 1.4mm Sterile
P99-202-1810-S	Olive Wire, Smooth, Short Tip, 1.8mm Sterile
P99-250-1309-S	Olive Wire, Smooth, 1.3mm, (Thru Guide) Sterile
P99-250-1606-S	Olive Wire, Smooth, 1.6mm, (Comp/Dist) Sterile
P99-250-1608-S	Olive Wire, Smooth, 1.6 x 80mm, Tower Wire, Standard Sterile
P99-250-1610-S	Olive Wire, Smooth, 1.6.x 100mm, Tower Wire, Long Sterile
P99-251-1607-S	Olive Wire, Threaded, 1.6 x 72mm Sterile
P99-251-2007-S	Olive Wire, Threaded, 2.0 x 72mm Sterile
P99-292-1110-S	K-Wire, 1.1mm, Smooth Double Trocar, 100mm Sterile packed
P99-292-1110	K-Wire, 1.1mm, Smooth Double Trocar, 100mm
P99-292-0915-S	K-Wire, Double Ended Trocar Tip, Smooth, Ø0.9 x 150 mm Sterile
P99-292-1115-S	K-Wire, Double Ended Trocar Tip, Smooth, Ø1.1 x 150 mm Sterile
P99-292-1415-S	K-Wire, Double Ended Trocar Tip, Smooth, 1.4 x 150mm Sterile
P99-292-1615-S	K-Wire, Double Ended Trocar Tip, Smooth, 1.6 x 150mm Sterile
P99-300-4013-S	Schanz Pin, 4.0mm, AO Connect Sterile
P99-300-5013-S	Schanz Pin, 5.0mm, AO Connect Sterile
P99-300-6013-S	Schanz Pin, 6.0mm, AO Connect Sterile

PATENTED, DESIGNED & EXCLUSIVELY DISTRIBUTED BY

Exclusively foot & ankle **28**
Paragon[®]

For the contraindications, potential complications and adverse reactions, warnings and precautions associated with these devices, please refer to the device specific instructions for use at <http://www.paragon28.com/ifus>

P28PG-01 Rev. A (2021.04.15)

™Trademarks and ®Registered Marks of
Paragon 28[®], Inc.

© Copyright 2021 Paragon 28[®], Inc. All
rights reserved.

Patents: www.paragon28.com/patents

Paragon 28, Inc. 
14445 Grasslands Dr.
Englewood, CO 80112 USA
(855) 786-2828

Paragon 28 Medical Devices Trading
Limited
First Floor Block 7 Beckett Way
Park West Business Park
Dublin 12
D12 X884
Ireland
+353 (0) 1588 0350

www.Paragon28.com