

**SURGICAL TECHNIQUE GUIDE:**

GORILLA® R3CON PLATING SYSTEM

Exclusively foot & ankle **20**  
**Paragon**®



**GORILLA**®  
R3CON PLATING SYSTEM

# SURGICAL TECHNIQUE GUIDE:

## GORILLA® R3CON PLATING SYSTEM

### Acknowledgment:

Paragon 28® would like to thank Mark Myerson, MD for his contribution to the development of the surgical technique guide.

### PRODUCT DESCRIPTION

The Gorilla® R3CON Plating System was carefully engineered to provide solutions for surgeons' foot and ankle reconstructive needs. The plates were designed to avoid disruption of nearby anatomic structures, while maintaining appropriate plate thickness for the intended surgical procedure.

### TABLE OF CONTENTS

	Page
Gorilla® Plate Offering	2 - 4
Gorilla® Plate Technology	4
Gorilla® R3CON Screw Offering and Technology	5
Gorilla® Featured Instruments	6 - 7
Gorilla® Plate and Screw Fixation	8
Compression Method #1: Compression Slot	9
Compression Method #2: Caspar Device	9 - 10
Compression Method #3: Lag Screw	10
Gorilla® R3CON Caddy Layout and Offering	11
Indications, Contraindication and Warnings	12 - 13

### PLATE OFFERING

#### MTP CADDY

##### MTP Plates

- 32 plate offerings
- Precision® Guide provided in plate caddy
- Instrumentation includes Reamers with patented Spin Guards



Short



Primary



Revision



Graft Spanning

#### LAPIDUS CADDY

##### Lapidus Plates

- 20 plate offerings
- Precision® Guide provided in plate caddy
- Medial wall curvature helps reduce 1<sup>st</sup> metatarsal adduction



Primary



Step-Off



Standard  
Armless



Graft  
Spanning

#### BOW & ARROW CADDY

##### Bow & Arrow Plates

- The "ARROW" latches onto the near cortex of bone
- Can be used with or without bone graft material
- Tapered back of Evans and Cotton plates matches each available size of the patented PRESERVE™ allograft wedges



Evans



Cotton



Base Opening  
Wedge

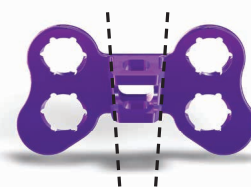

ARROW



# SURGICAL TECHNIQUE GUIDE:

## GORILLA R3CON PLATING SYSTEM

### PLATE OFFERING

#### UNIVERSAL CADDY

##### Universal Plates

- Multiple size options available for each plate



#### LISFRANC CADDY

##### Lisfranc Plates

- Multiple size options available for each plate
- Plate contoured for unique anatomy at the tarsometatarsal joint
- Multiple uses including trauma and arthrodesis



#### CALC SLIDE CADDY

##### Calc Slide Plate

- Universal for right and left
- Can be used for medial or lateral calcaneal slide osteotomies



#### CALC FRACTURE CADDY

##### Calc Fracture Plates

- 20 plate offerings
- Sinus Tarsi Support Plate Incision Guide and Plate Inserter provided in plate caddy
- Shanz Pins and T-Handle provided in plate caddy



#### NC FUSION CADDY

##### NC Fusion Plate

- 8 plate offerings
- 8 Trial Templates with Reamer to create recessed hole
- Precision Guide in plate caddy allows for placement of crossing screw across arthrodesis



#### LATERAL COLUMN FUSION CADDY

##### Lateral Column Fusion Plate

- 4 plate offerings
- 4 Trial Templates with Reamer to create recessed hole for crossing screw placement





# SURGICAL TECHNIQUE GUIDE:

## GORILLA R3CON PLATING SYSTEM

### PLATE OFFERING

#### MEDIAL COLUMN CADDY

##### Medial Column Plates

- 30 plate offerings
- 6 Medial Column Rescue Plates
- 10 Medial Column Straddle Plates
- Some plates offered in multiple thicknesses - 1.5 mm and 2.0 mm

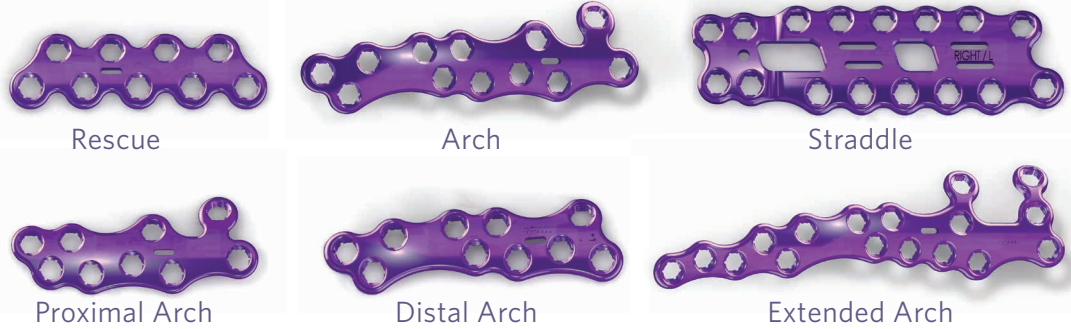

#### ANKLE FRACTURE CADDY

##### Ankle Fracture Plates

- 52 plate offerings
  - 29 Fibular Plates
  - 15 Tibial Plates
  - 8 Hook Plates
- Additional Ankle Fracture specific instrumentation in caddy

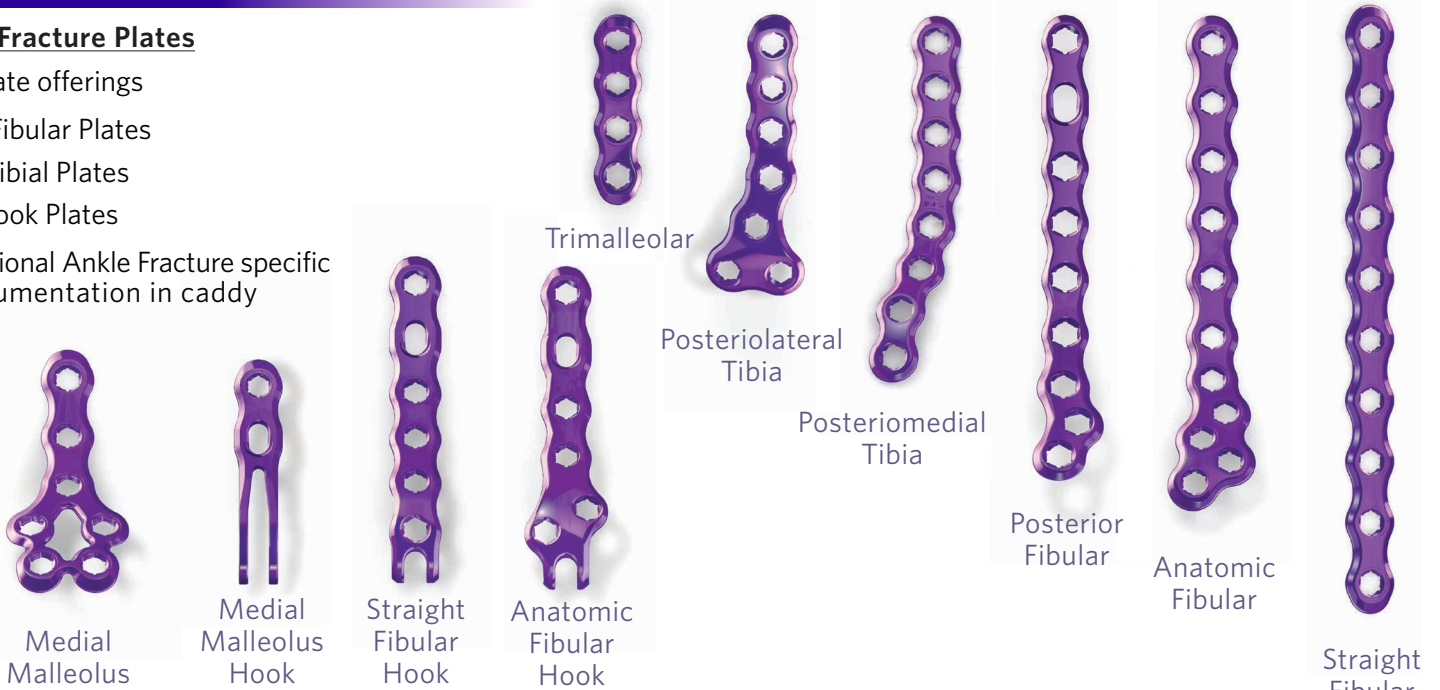

#### GORILLA PLATE TECHNOLOGY

##### Ramped Compression Slot

Available in most plates for compression capability. The ramped compression hole allows for up to 2.9 mm of total compression, and is designed to direct a screw down the ramp, guiding the bone in a direction of compression. All three non-locking screw diameters are accepted, with the smaller diameter screws recommended for use in more narrow bone.



##### 6 Scallop Holes

Initiates threading of the locking screw head into the plate, while allowing for off-axis locking capability

##### Angled Screw Holes

Some plate holes are machined at an angle to direct plate screws such that they do not align perpendicular to the top surface of the plate. This allows for better anatomic accuracy when necessary, avoidance of other screws and increased space for a crossing lag screw.



# SURGICAL TECHNIQUE GUIDE:

## GORILLA R3CON PLATING SYSTEM

### GORILLA R3CON SCREW TECHNOLOGY

#### Hard Headed

Locking screw has a titanium nitride (TiN) coating to bite adequately into the plate to invoke variable angle locking without screw head stripping.

#### Double Lead Threads

Allow for a steeper helix angle resulting in quicker screw insertion.

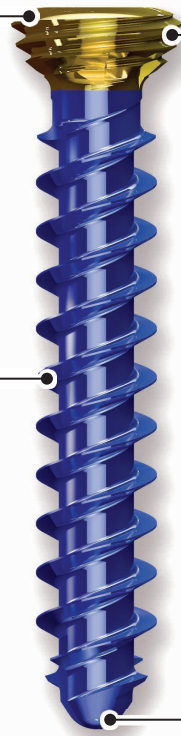

#### Tapered Screw Head

Creates a lag effect to allow locking screws to lag and contour the plate to bone, rather than only relying on non-locking screws for this application.

#### Hexalobe Drive

Designed to maximize surface contact and torque transmission between the driver and screw, thus helping to reduce screw head stripping.

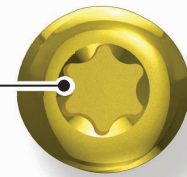

#### Blunt Tip Design

Minimizes soft tissue irritation at the tip of the screw and is designed for bicortical fixation.

#### Variable Angle Locking

Creates a locked screw construct up to 15° in every screw hole (with the exception of the compression slot).

**TIP:** In thinner plates, variable angle locking may result in the screw head being proud following insertion. It is advised to avoid variable angle locking in areas where soft tissue irritation may be a problem.



### GORILLA R3CON SCREW OPTIONALITY

#### LOCKING SCREW

#### Optionality



Locking screws are available in 2.7 mm, 3.5 mm and 4.2 mm diameters.

2.7 mm	Locking	1 mm increments, 8-20 mm	
2.7 mm	Locking	2 mm increments, 22-40 mm	
3.5 mm	Locking	2 mm increments, 10-50 mm	
4.2 mm	Locking	2 mm increments, 10-50 mm	
4.2 mm	Locking	5 mm increments, 55-70 mm	

#### NON-LOCKING SCREW

#### Optionality



Non-locking screws are available in 2.7 mm, 3.5 mm and 4.2 mm diameters.

2.7 mm	Non-Locking	1 mm increments, 8-20 mm	
2.7 mm	Non-Locking	2 mm increments, 22-40 mm	
3.5 mm	Non-Locking	2 mm increments, 10-50 mm	
4.2 mm	Non-Locking	2 mm increments, 10-50 mm	
4.2 mm	Non-Locking	5 mm increments, 55-70 mm	

**FEATURED INSTRUMENTS**

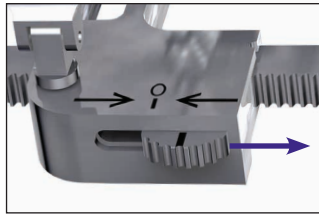

Compression Setting

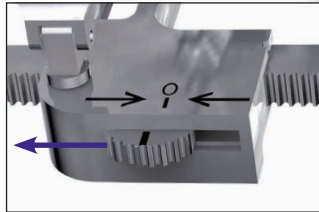

Distraction Setting

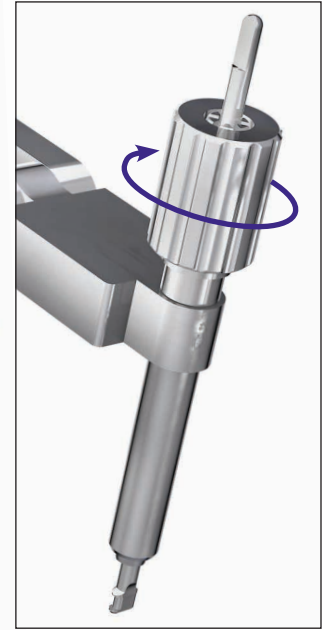
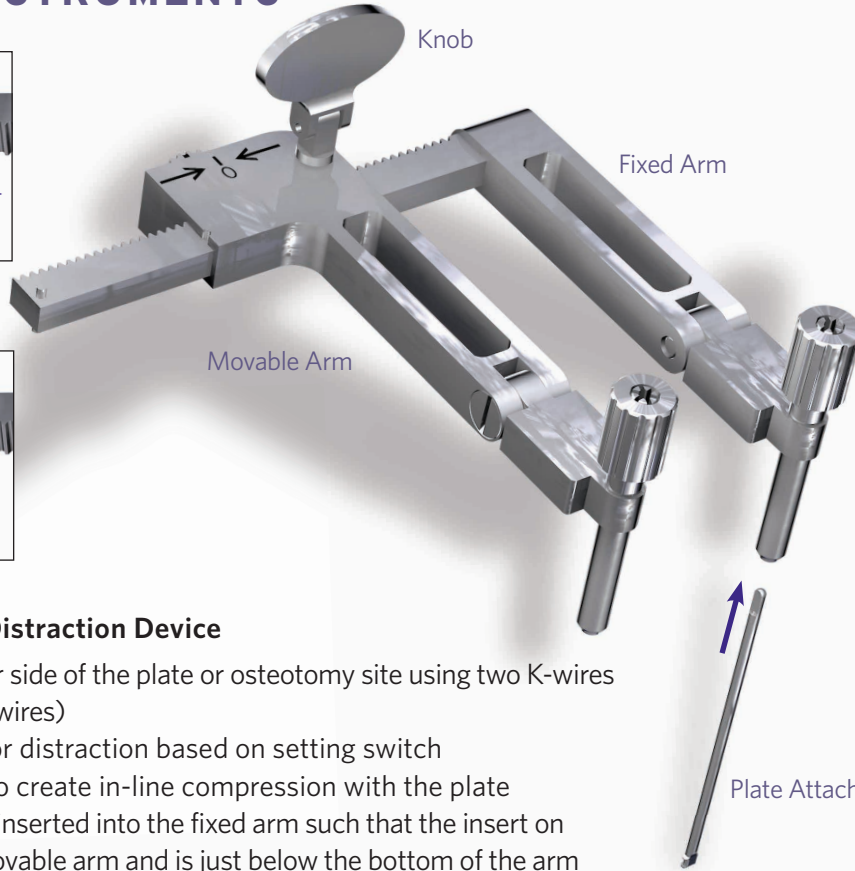

Correct Position of Plate Attachment

**Caspar Compression/Distractor Device**

- Can be secured on either side of the plate or osteotomy site using two K-wires (allows up to 2.3 mm K-wires)
- Provides compression or distraction based on setting switch
- Has plate attachment to create in-line compression with the plate
- The plate attachment is inserted into the fixed arm such that the insert on the hook is facing the movable arm and is just below the bottom of the arm



**Pin Distractor**

- Sized for foot and ankle applications
- Smaller holes accept up to 1.6 mm K-wires
- Larger holes accept up to 2.3 mm K-wires



**Honey Badger Cartilage Removal Tool**

- Provides "reverse cutting" functionality
- Ideal for debridement of curved, small and/or difficult to access joints



**San Gio Retractor**

- Sized and contoured for foot and ankle surgery



Handles





# SURGICAL TECHNIQUE GUIDE:

## GORILLA R3CON PLATING SYSTEM

### FEATURED INSTRUMENTS

#### Drill Guide Options

##### Cone Side

- Allows for off-axis drilling of locking screws up to 15° in any direction or 30° total

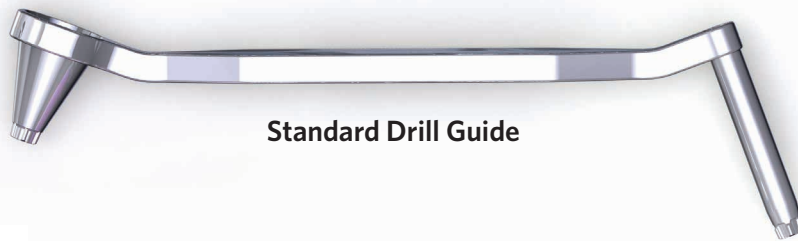

##### EZ-Guide Side

- Serves as an alternative to the threaded locking drill guide and allows for quick on-axis drilling

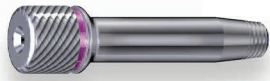

2.7 mm



3.5 mm



4.2 mm

##### Threaded Drill Guide

- For on-axis drilling of locking screw holes



2.7 mm



3.5 mm



4.2 mm

##### Oblong Drill Guide

- For ramped compression slot



Ø2.0 x 110 mm Drill



Ø2.4 x 140 mm Drill



Ø2.8 x 140 mm Drill



##### Subchondral Drill

- Useful during preparation of an arthrodesis, the subchondral drill provides approximately 10 mm of controlled drilling of subchondral bone, featuring a stop on the drill to help prevent deeper penetration



##### Depth Gauge

- Designed specifically to fit and accurately measure foot and ankle bones.



TR-10 Driver



##### Washers

- Available for use with non-locking screws when non-locking screws are used outside of the plate.



##### Plate Benders



**TIP:** It is recommended to underbend the plate in small increments to adjust the plate to the appropriate contour. Only bend the plate in one direction, and do not attempt to reverse bend the plate once bending has been performed. If the plate is not exactly contoured to bone, allow the lag effect of the screw to the plate to account for smaller mismatches in contour.

# SURGICAL TECHNIQUE GUIDE:

## 2<sup>ND</sup> TAROMETATARSAL JOINT ARTHRODESIS

The purpose of this portion of the surgical technique guide is to demonstrate the general use of a Gorilla plate and R3CON screw system while highlighting the instrumentation available.

### INCISION/EXPOSURE

A longitudinal incision is made over the 2nd tarsometatarsal joint.

Dissection is continued to expose the 2nd tarsometatarsal joint while identifying and retracting the neurovascular bundle.

Following exposure of the joint surfaces, cartilage resection and temporary fixation is performed according to surgeon preference.



### PLATE SELECTION AND FIXATION

Select a plate for your particular application. In this example, a Gorilla 2<sup>8</sup> 4-Hole Compression plate is shown.

Attach a threaded drill tower to a locking screw hole on the side of the plate opposite the compression slot. The plate can be temporarily secured across the arthrodesis site using two olive wires, avoiding the compression slot and the locking hole with the drill guide.

**TIP:** If additional lagging of the plate to bone is required, use the EZ-Guide side of the standard drill guide instead of the threaded drill guide to bend the plate while drilling.

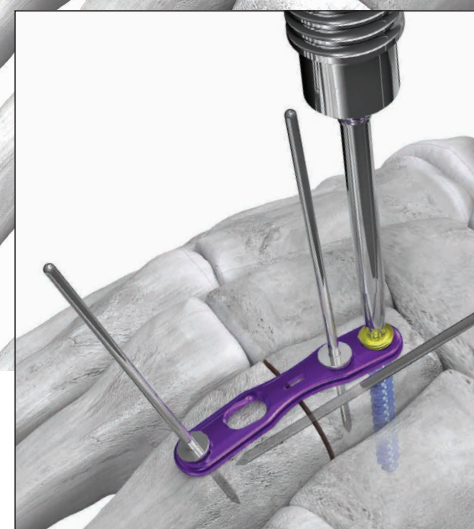
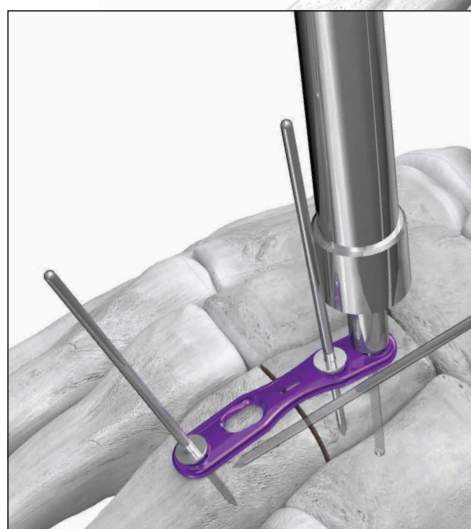
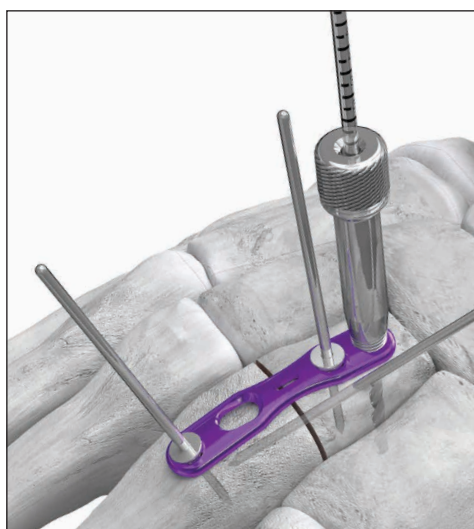
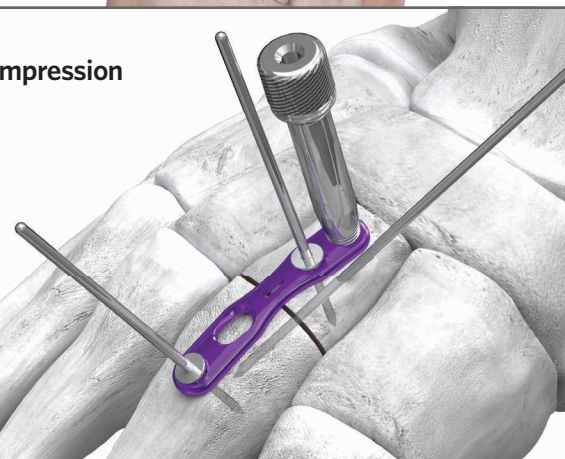

Drill using the drill corresponding to the desired plate screw diameter. The color band on the drill and drill guide corresponds to the screw diameter and color.

Screw length can be measured using the provided depth gauge or by measuring off of the drill using the drill guide.

Attach the provided driver to a handle or power adapter and insert the selected locking or non-locking screw. It is advised to avoid final tightening of the plate screws into the locked position until all plate screws are inserted. Final tightening of the screws should only be done by hand.



## SURGICAL TECHNIQUE GUIDE:

### 2<sup>ND</sup> TAROMETATARSAL JOINT ARTHRODESIS

#### COMPRESSION METHOD 1: COMPRESSION SLOT

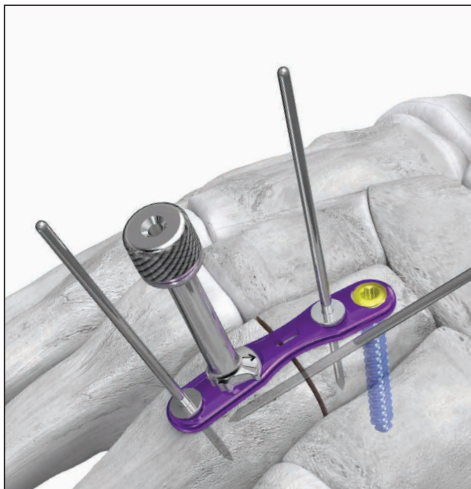

To insert a non-locking screw into the plate compression slot, retrieve the oblong drill guide. Place the drill guide into the compression slot with the arrow pointing towards the arthrodesis site.

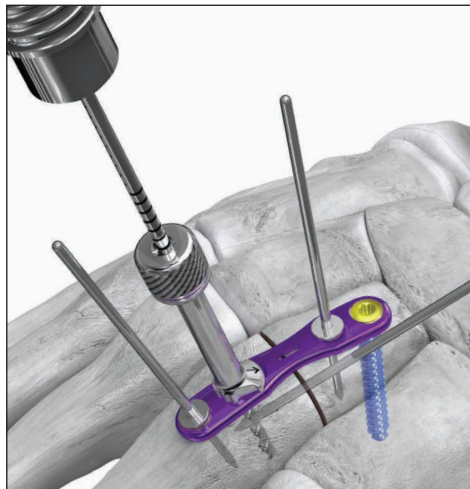

Drill through the drill guide using the drill corresponding to the desired compression screw. Measure the screw length using the depth gauge.

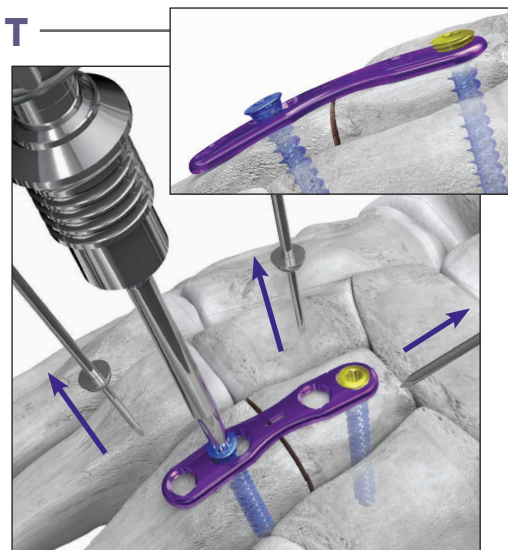

Attach the provided driver to a handle or power adapter and insert the selected screw until only the head and neck of the screw are visible. Remove temporary fixation across the arthrodesis site and the olive wires in the plate.



Continue to advance the compression screw until it engages the plate and tighten until the screw is flush with the plate or adequate compression is achieved. Final tightening of the screws should only be done by hand.

#### COMPRESSION METHOD 2: USING THE CASPAR DEVICE

Obtaining compression with the Caspar Device can be performed after placing a screw in the compression slot (Compression Method 1) as shown or prior to any screw placement by placing the device external to the plate. This method should not be performed after lag screw insertion, as it will result in loosening of the lag screw.



Attach the hook on the Caspar device to the slotted hole in the plate, with the movable arm positioned past the plate on the side with the compression slot.

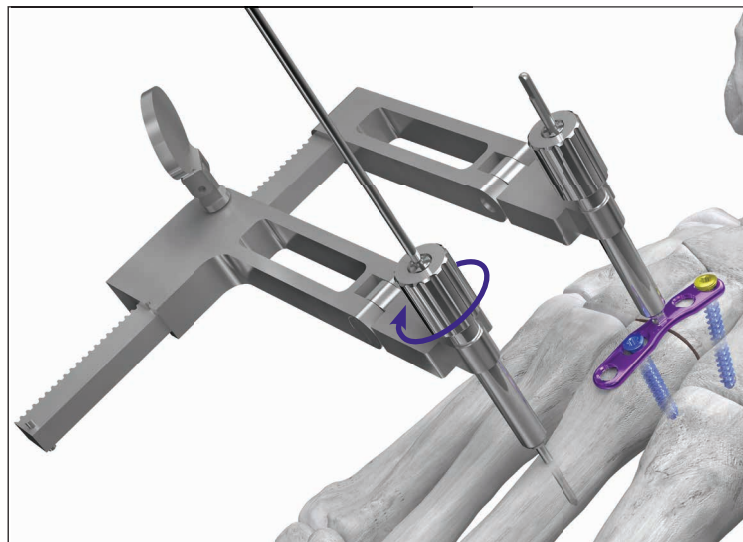

Use a K-wire driver to insert from a 1.6 mm to a 2.5 mm K-wire into the movable arm of the Caspar device. Once the K-wire is inserted, turn the collet around this K-wire in a clockwise manner to secure the Caspar device to the K-wire.

### COMPRESSION METHOD 2: USING THE CASPAR DEVICE

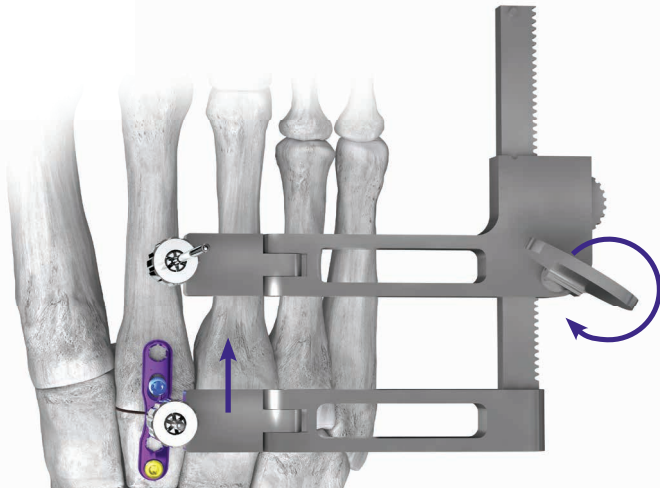

Turn the knob in a clockwise direction to create compression across the arthrodesis or fracture site until adequate compression is achieved.

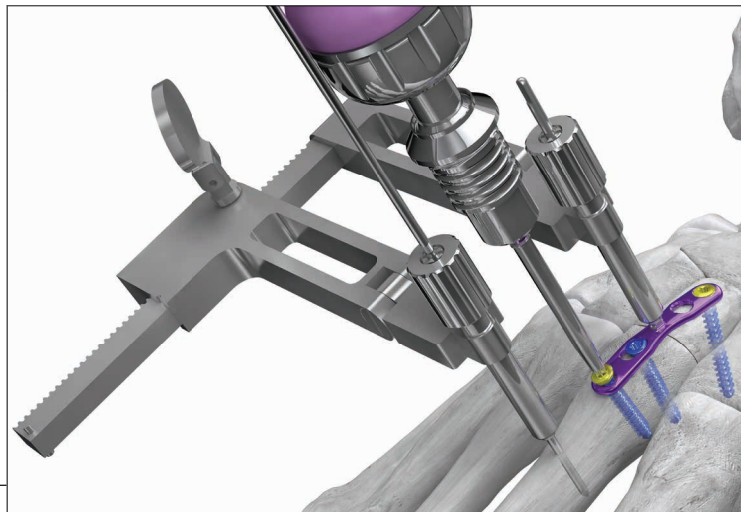

To maintain this compression, insert a locking screw into the compression slot side of the plate.

Remove the Caspar device and associated K-wires.

### COMPRESSION METHOD 3: LAG SCREW TECHNIQUE

Inserting a lag screw across the arthrodesis site can be performed prior to plate placement and fixation, or following the two methods of compression previously described. It is recommended to add a screw that crosses the arthrodesis site to create further stability to the construct. Mini-Monster<sup>®</sup> cannulated screws or Mini-Monster<sup>®</sup> solid screws can be used, based on surgeon preference.



Compression Methods 1 and 2 should not be performed after lag screw placement, as this can loosen the lag screw.

**TIP:** If using a Gorilla MTP, Lapidus or NC plate, the Precision Guide can be used for ease of insertion of a lag screw with clear trajectory across the arthrodesis site. Please see the surgical technique guides for these particular plates for explanation of use of this technology.

### CLOSURE

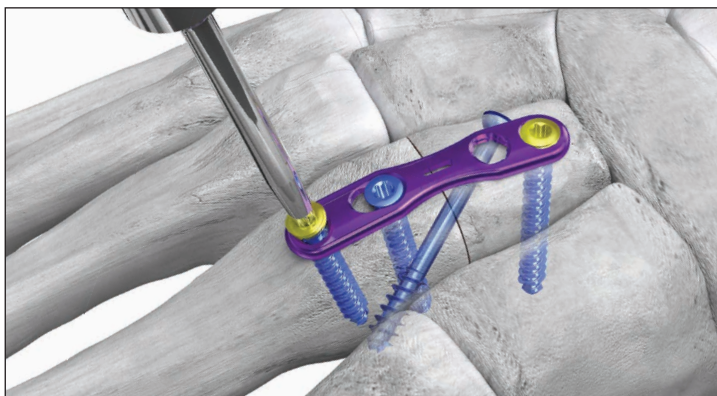

Continue to fill remaining holes of the Gorilla plate with locking or non-locking screws of choice. It is advised to avoid final tightening of the screws into a locked position until all screws are inserted. Final tightening of the screws should only be done by hand.

Confirm plate and screw placement using fluoroscopy, if desired.

Proceed to incision closure or concomitant procedures at this time.



## Gorilla® Caddies

The Gorilla® Case has room for up to 3 full size Gorilla® caddies and PRESERVE™ Allograft trial caddies. All caddy options include:

- Gorilla® Ankle Fracture Plating Caddy
- Gorilla® Ankle Fracture Posterior and Hook Plating Caddy
- Gorilla® BOW & ARROW® Plating Caddy
- Gorilla® Calcaneal Fracture Plating Caddy
- Gorilla® Calc Slide Caddy
- Gorilla® Lapidus Plating Caddy
- Gorilla® Lateral Column Fusion Caddy
- Gorilla® Lisfranc Plating Caddy
- Gorilla® Medial Column Plating Caddy

- Gorilla® MTP Plating Caddy
- Gorilla® NC Fusion Caddy
- Gorilla® Universal Plating Caddy
- PRESERVE™ Lapidus Allograft Trial Caddy
- PRESERVE™ MTP Allograft Trial Caddy
- PRESERVE™ Evans and Cotton Trial Caddy
- PRESERVE™ Subtalar and Calc-Cuboid Caddy
- PRESERVE™ HammerGraft™ and HammerTube™ Caddy

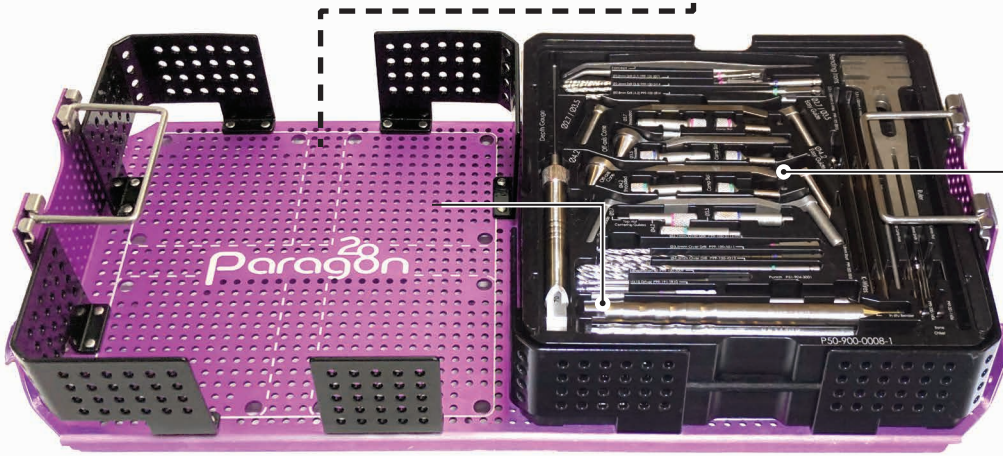

## Gorilla® R3CON Instrument Caddy

Drills, drill guides, centering guides, olive wires, plate benders, drivers, K-wires and a depth gauge are located in the Gorilla® R3CON Instrument Caddy.

## Mini-Monster® Screw Caddy

The Gorilla® Case can accommodate one Mini-Monster® Screw Caddy if a 2.0 mm, 2.5 mm, 3.0 mm, 3.5 mm or 4.0 mm cannulated screw is needed during a case.





## Gorilla® Case



## Gorilla® Screw Optionality

The Gorilla® screw length options for both locking and non-locking screws are as follows:

2.7 mm	1 mm increments, 8-20 mm	
2.7 mm	2 mm increments, 22-40 mm	
3.5 mm	2 mm increments, 10-50 mm	
4.2 mm	2 mm increments, 10-50 mm	
4.2 mm	5 mm increments, 55-70 mm	

## Gorilla® R3CON Instruments

The Caspar Compression/Distraction device, osteotomes, baby Bennet retractors, bone reduction clamps, periosteal elevator, cartilage removal device, pin distractor and handles are located at the bottom of the Gorilla® Case.



# SURGICAL TECHNIQUE GUIDE: INDICATIONS, CONTRAINDICATIONS, AND WARNINGS

Refer to [www.paragon28.com/ifus](http://www.paragon28.com/ifus) for the complete and most current instructions for use document.

## INDICATIONS FOR USE (GORILLA®)

The bone plates and bone screws of the Baby Gorilla®/Gorilla® Plating System are indicated for use in stabilization and fixation of fractures or osteotomies; intra and extra articular fractures, joint depression, and multi-fragmentary fractures; revision procedures, joint fusion and reconstruction of small bones of the toes, feet and ankles including the distal tibia, distal fibula, talus, and calcaneus. The system can be used in both adult and pediatric patients.

In addition, the non-locking, titanium alloy (Ti6Al4V ELI) screws and washers are indicated for use in bone reconstruction, osteotomy, arthrodesis, joint fusion, fracture repair and fracture fixation of the foot and ankle, including the tibia, fibula, tarsus, metatarsals, and phalanges, appropriate for the size of the device.

## CONTRAINDICATIONS

Use of the Baby Gorilla®/Gorilla® Plating System is contraindicated in cases of inflammation, cases of active or suspected sepsis / infection and osteomyelitis; or in patients with certain metabolic diseases.

All applications that are not defined by the indications are contraindicated. In addition, surgical success can be adversely affected by:

- Acute or chronic infections, local or systemic
- Vascular, muscular or neurological pathologies that compromise the concerned extremity
- All concomitant pathologies that could affect the function of the implant
- Osteopathies with reduced bone substance that could affect the function of the implant
- Any mental or neuromuscular disorder that could result in an unacceptable risk of failure at the time of fixation or complications in post-operative treatment
- Known or suspected sensitivity to metal
- Corpulence; an overweight or corpulent patient can strain the implant to such a degree that stabilization or implant failure can occur
- Whenever the use of the implant comes into conflict with the anatomical structures of physiological status

Other medical or surgical pre-conditions that could compromise the potentially beneficial procedure, such as:

- The presence of tumors
- Congenital abnormalities
- Immunosuppressive pathologies
- Increased sedimentation rates that cannot be explained by other pathologies
- Increased leukocyte (WBC) count
- Pronounced left shift in the differential leukocyte count

## POTENTIAL COMPLICATIONS AND ADVERSE REACTIONS

In any surgical procedure, the potential for complications and adverse reactions exist. The risks and complications with these implants include:

- Loosening, deformation or fracture of the implant
- Acute post-operative wound infections and late infections with possible sepsis
- Migration, subluxation of the implant with resulting reduction in range of movement
- Fractures resulting from unilateral joint loading
- Thrombosis and embolism
- Wound hematoma and delayed wound healing
- Temporary and protracted functional neurological perturbation
- Tissue reactions as the result of allergy or foreign body reaction to dislodged particles
- Corrosion with localized tissue reaction and pain
- Pain, a feeling of malaise or abnormal sensations due to the implant used
- Bone loss due to stress shielding

All possible complications listed here are not typical of Paragon 28®, Inc. products but are in principle observed with any implant. Promptly inform Paragon 28®, Inc. as soon as complications occur in connection with the implants or surgical instruments used. In the event of premature failure of an implant in which a causal relationship with its geometry, surface quality or mechanical stability is suspected, please provide Paragon 28®, Inc. with the explant(s) in a cleaned, disinfected and sterile condition. Paragon 28®, Inc. cannot accept any other returns of used implants. The surgeon is held liable for complications associated with inadequate asepsis, inadequate preparation of the osseous implant bed in the case of implants, incorrect indication or surgical technique or incorrect patient information and consequent incorrect patient behavior.

## WARNINGS AND PRECAUTIONS

- Re-operation to remove or replace implants may be required at any time due to medical reasons or device failure. If corrective action is not taken, complications may occur.
- Use of an undersized plate or screw in areas of high functional stresses may lead to implant fracture and failure.
- Plates and screws, wires, or other appliances of dissimilar metals should not be used together in or near the implant site.
- The implants and guide wires are intended for single use only.
- Instruments, guide wires and screws are to be treated as sharps.
- Do not use other manufacturer's instruments or implants in conjunction with the Baby Gorilla®/Gorilla® Plating System.
- Do not implant the instruments.

## MR SAFETY INFORMATION

The Baby Gorilla®/Gorilla® Plating System has not been evaluated for safety and compatibility in the MR environment. It has not been tested for heating, migration or image artifact in the MR environment. The safety of the Baby Gorilla®/Gorilla® Plating System in the MR environment is unknown. Scanning a patient who has this device may result in patient injury.

# SURGICAL TECHNIQUE GUIDE: INDICATIONS, CONTRAINDICATIONS, AND WARNINGS

Refer to [www.paragon28.com/ifus](http://www.paragon28.com/ifus) for the complete and most current instructions for use document.

## INDICATIONS FOR USE (MONSTER®)

The Monster® Screw System is indicated for use in bone reconstruction, osteotomy, arthrodesis, joint fusion, ligament fixation, fracture repair and fracture fixation of the foot and ankle, including the tibia, fibula, tarsus, metatarsals, and phalanges and the joints and ligaments coupling said bones, appropriate for the size of the device.

## CONTRAINDICATIONS

Use of the Monster® Screw System is contraindicated in cases of inflammation, cases of active or suspected sepsis / infection and osteomyelitis; or in patients with certain metabolic diseases.

All applications that are not defined by the indications are contraindicated. In addition, surgical success can be adversely affected by:

- Acute or chronic infections, local or systemic
- Vascular, muscular or neurological pathologies that compromise the concerned extremity
- All concomitant pathologies that could affect the function of the implant
- Osteopathies with reduced bone substance that could affect the function of the implant
- Any mental or neuromuscular disorder that could result in an unacceptable risk of failure at the time of fixation or complications in post-operative treatment
- Known or suspected sensitivity to metal
- Corpulence; an overweight or corpulent patient can strain the implant to such a degree that stabilization or implant failure can occur
- Whenever the use of the implant comes into conflict with the anatomical structures of physiological status

Other medical or surgical pre-conditions that could compromise the potentially beneficial procedure, such as:

- The presence of tumors
- Congenital abnormalities
- Immunosuppressive pathologies
- Increased sedimentation rates that cannot be explained by other pathologies
- Increased leukocyte (WBC) count
- Pronounced left shift in the differential leukocyte count

## POTENTIAL COMPLICATIONS AND ADVERSE REACTIONS

In any surgical procedure, the potential for complications and adverse reactions exist. The risks and complications with these implants include:

- Loosening, deformation or fracture of the implant
- Acute post-operative wound infections and late infections with possible sepsis
- Migration, subluxation of the implant with resulting reduction in range of movement
- Fractures resulting from unilateral joint loading
- Thrombosis and embolism
- Wound hematoma and delayed wound healing
- Temporary and protracted functional neurological perturbation
- Tissue reactions as the result of allergy or foreign body reaction to dislodged particles
- Corrosion with localized tissue reaction and pain
- Pain, a feeling of malaise or abnormal sensations due to the implant used
- Bone loss due to stress shielding

All possible complications listed here are not typical of Paragon 28®, Inc. products but are in principle observed with any implant. Promptly inform Paragon 28® as soon as complications occur in connection with the implants or surgical instruments used. In the event of premature failure of an implant in which a causal relationship with its geometry, surface quality or mechanical stability is suspected, please provide Paragon 28® with the explant(s) in a cleaned, disinfected and sterile condition. Paragon 28® cannot accept any other returns of used implants. The surgeon is held liable for complications associated with inadequate asepsis, inadequate preparation of the osseous implant bed in the case of implants, incorrect indication or surgical technique or incorrect patient information and consequent incorrect patient behavior.

## WARNINGS AND PRECAUTIONS

- Re-operation to remove or replace implants may be required at any time due to medical reasons or device failure. If corrective action is not taken, complications may occur.
- Use of an undersized screw in areas of high functional stresses may lead to implant fracture and failure.
- Plates and screws, wires, or other appliances of dissimilar metals should not be used together in or near the implant site.
- The implants and guide wires are intended for single use only. Re-use may cause product failure and could lead to disease transmission.
- Instruments, guide wires and screws are to be treated as sharps.
- **Do not use other manufacturer's instruments or implants in conjunction with the Monster® Screw System.**

## MR SAFETY INFORMATION

The Monster® Screw System has not been evaluated for safety and compatibility in the MR environment. It has not been tested for heating, migration or image artifact in the MR environment. The safety of the Monster® Screw System in the MR Environment is unknown. Scanning a patient who has this device may result in patient injury.



PATENTED, DESIGNED & EXCLUSIVELY DISTRIBUTED BY

Exclusively foot & ankle **28**  
**Paragon**®

[www.PARAGON28.com](http://www.PARAGON28.com)

P51-STG-2001 RevB

™Trademarks and ®Registered Marks of Paragon 28®, Inc.

© Copyright 2020 Paragon 28®, Inc. All rights reserved.

Patents: [www.paragon28.com/patents](http://www.paragon28.com/patents)

Paragon 28, Inc.   
14445 Grasslands Dr.  
Englewood, CO 80112  
(855) 786-2828

 2797

Paragon 28 Medical Devices Trading Limited  
First Floor Block 7 Beckett Way  
Park West Business Park  
Dublin 12  
D12 X884  
Ireland  
+353 (0) 1588 0350

#### DISCLAIMER

The purpose of the Gorilla® R3CON Plating System Surgical Technique Guide is to demonstrate use of the Gorilla® Plates in the Gorilla® R3CON Plating System. Although various methods can be employed for this procedure, the fixation options demonstrated were chosen for simplicity of explanation and demonstration of the unique features of our device. Federal law (U.S.A.) restricts this device to sale and use by, or on order of, a physician.