

Exclusively foot & ankle **20**
Paragon[®]



SURGICAL TECHNIQUE GUIDE

Tibiotalar/Tibiotalocalcaneal Arthrodesis



SILVERBACK[™]
ANKLE FUSION PLATING SYSTEM

PRODUCT DESCRIPTION

The Paragon 28[®] Silverback[™] Ankle Fusion Plating System was designed to give surgeons options for tibiotalar (TT) and tibiotalocalcaneal (TTC) arthrodesis. The system includes anterior, lateral, and posterior approach specific plating families helps accommodate variations in anatomy for both TT and TTC versions.

Both the Anterior and Posterior plates include two forms, a flat and contoured version to help accommodate variations in anatomy for both TT and TTC versions. The Lateral plates are available in TT and TTC versions. To accommodate arthroscopic or mini-open fusion procedures, an Anterior Mini-Open Plate is available to be used in combination with cannulated screws for increased construct rigidity and decreased micromotion at the tibiotalar joint when compared to cannulated screws in isolation. The relatively thinner plates help to evenly distribute force across the construct and guard against stress shielding during healing.

Plate hole sizing allows for Ø4.5 mm and Ø5.2 mm screws to be used for the tibia and calcaneus, while the talar screw holes allow for Gorilla[®] R3CON Ø3.5 mm and Ø4.2 mm screws, with the exception of the Mini-Open Plate which uses a Silverback screw in the talar body. A Ø4.7 mm “Compact” screw is available for the hole sizes in the tibia and calcaneus, which was designed with a smaller thread height to help reduce insertion torque in dense bone. Additionally, single lead bone threads result in a decreased pitch differential between the locking screw head and bone threads to reduce the amount of insertion torque required to lock the screw into the plate in areas of dense bone. Precision[®] Guides are provided to allow for a crossing screw to be inserted outside of the plate while avoiding interference with the on-axis plate screws. Each plate has one Precision[®] Guide to place a tibiotalar screw, while the Lateral and Posterior TTC plates have an additional Precision[®] Guide to place the subtalar crossing screw. The Anterior Mini-Open Plates have two Precision[®] Guides to provide placement of independent medial and lateral crossing screws across the tibiotalar joint.

TABLE OF CONTENTS

INTRODUCTION	IMPLANTS: PLATE FAMILIES	3
	FEATURED INSTRUMENTS	4-6
FEATURED TECHNIQUES	ANTERIOR TIBIOTALAR ARTHRODESIS	7-11
	ANTERIOR TIBIOTALCALCANEAL ARTHRODESIS	12-15
	ANTERIOR MINI-OPEN TIBIOTALAR ARTHRODESIS	16-22
	LATERAL TIBIOTALCALCANEAL ARTHRODESIS	23-26
	LATERAL TIBIOTALAR ARTHRODESIS	27
	POSTERIOR TIBIOTALAR ARTHRODESIS	28-32
	POSTERIOR TIBIOTALCALCANEAL ARTHRODESIS	33-38
APPENDIX	CADDY LAYOUT	39
	INDICATIONS CONTRAINDICATIONS, AND WARNINGS	40-42

Acknowledgment:

Paragon 28 would like to thank Byron Hutchinson, DPM and Mark Myerson, MD for their contribution to the development of the surgical technique guide.

ANKLE FUSION PLATES

Available in Right (shown) and Left Configurations

Anterior TT Plates

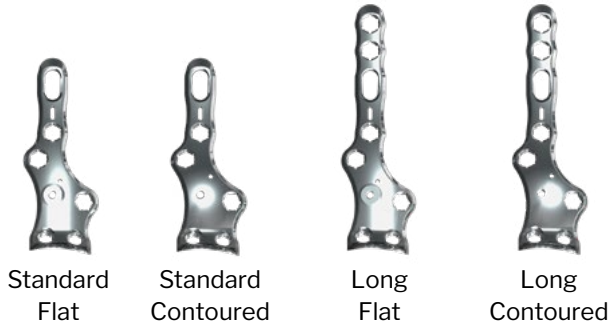

Anterior TTC Plates

Central talar body hole allows for a Ø7.0 mm Monster® Screw across the subtalar joint

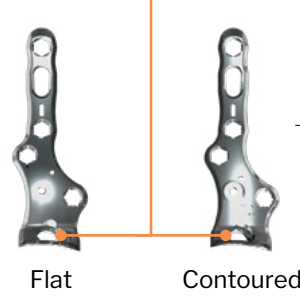

Side Profile

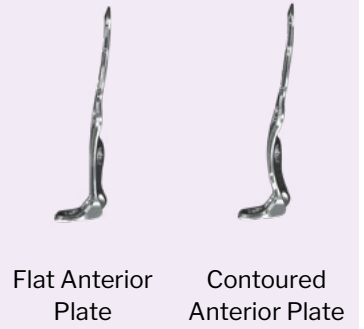

Anterior Mini-Open Plate

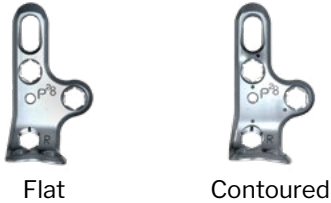

Side Profile

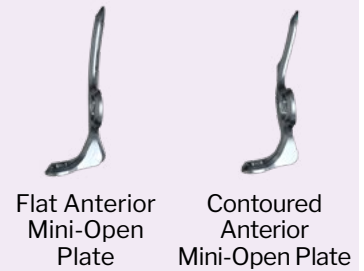

Lateral TT Plates



Lateral TTC Plates



Side Profile

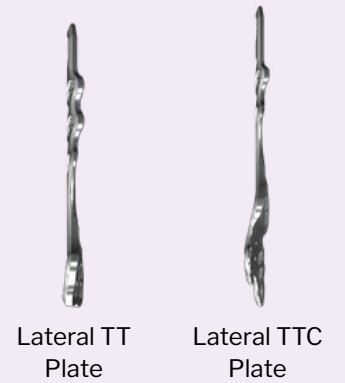

Posterior TT Plates

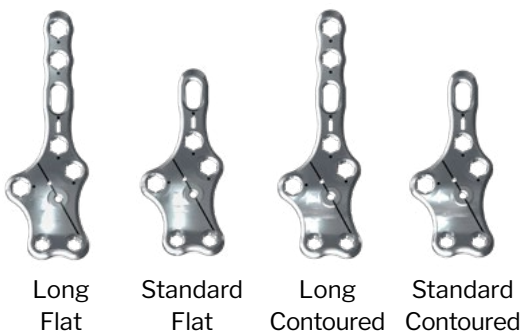



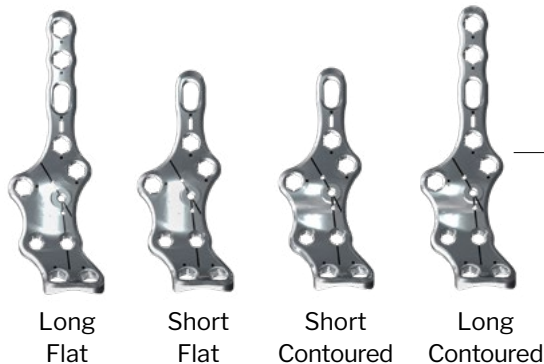



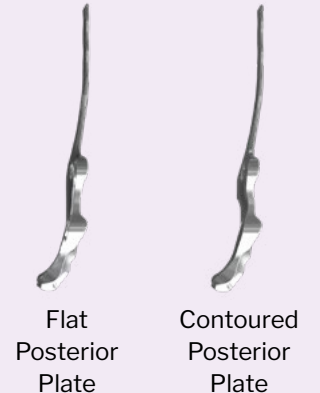





























Posterior TTC Plates



Side Profile



FEATURED INSTRUMENTS

	Ø3.5 mm R3CON Screws	Ø4.2 mm R3CON Screws	Ø4.5 mm SILVERBACK™ Screws	Ø5.2 mm SILVERBACK™ Screws	Ø4.7 mm SILVERBACK™ Compact Screws
Locking:					
Non-locking:					
Screw Lengths:	14 mm - 30 mm in 2 mm increments	14 mm - 50 mm in 2 mm increments and 55 mm - 60 mm in 5 mm increments			20 mm - 40 mm in 2 mm increments
Drill Size:	Ø2.4 mm 	Ø2.8 mm 	Ø3.1 mm 	Ø3.6 mm 	Ø3.6 mm 
Driver Size:	HX-10 	HX-10 	HX-15 	HX-15 	HX-15 
Locking Drill Guide Size	Ø3.5 mm 	Ø4.2 mm 	Ø4.5 mm 	Ø4.7/Ø5.2 mm 	Ø4.7/Ø5.2 mm 
Centering Drill Guide Size	Ø3.5 mm 	Ø4.2 mm 	Ø4.5 mm 	Ø5.2 mm 	N/A
Compression Slot Drill Guide Size:	N/A	N/A	Ø4.5 mm 	Ø4.7/Ø5.2 mm 	Ø4.7/Ø5.2 mm 
Cone/Straight Easy Guide Size:	Ø3.5 mm 	Ø4.2 mm 	Ø4.5 mm 	Ø4.7/Ø5.2 mm 	Ø4.7/Ø5.2 mm 

Drill



Driver



Locking Drill Guide



Centering Drill Guide



Compression Slot Drill Guide



Cone/Straight Easy Guide



JOINT PREPARATION INSTRUMENTATION

Bone Fenestration Perforator



Curved Bone Fenestration Chisel



Cartilage Removal Tool



Angled Ring Curette



Straight Ring Curette



Angled Curette



Straight Curette



Oval Burr



Barrel Burr



Straight Bone Fenestration Chisel



Curved 3 mm Osteotome



Straight 6 mm Osteotome



Curved 6 mm Osteotome



Straight 12 mm Osteotome



Curved 12 mm Osteotome



OTHER INSTRUMENTATION

Ø2.5 & Ø3.0 mm K-wire Hindfoot Distractor



Overdrill Guide



AO Handles



Flat Plate Benders

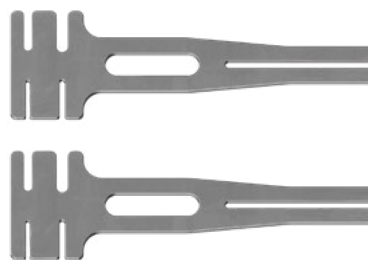

Threaded Plate Bending Bars



Olive Wire, Short (Smooth and Threaded)



Ø2.0 x 200 mm K-wire (Smooth and Threaded)



Olive Wire, Long (Smooth and Threaded)

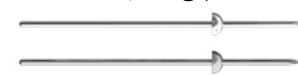

Ø2.5 x 150 mm K-wire (Smooth and Threaded)



JOINT PREPARATION INSTRUMENTATION

Anterior TT/TTC Precision Guide

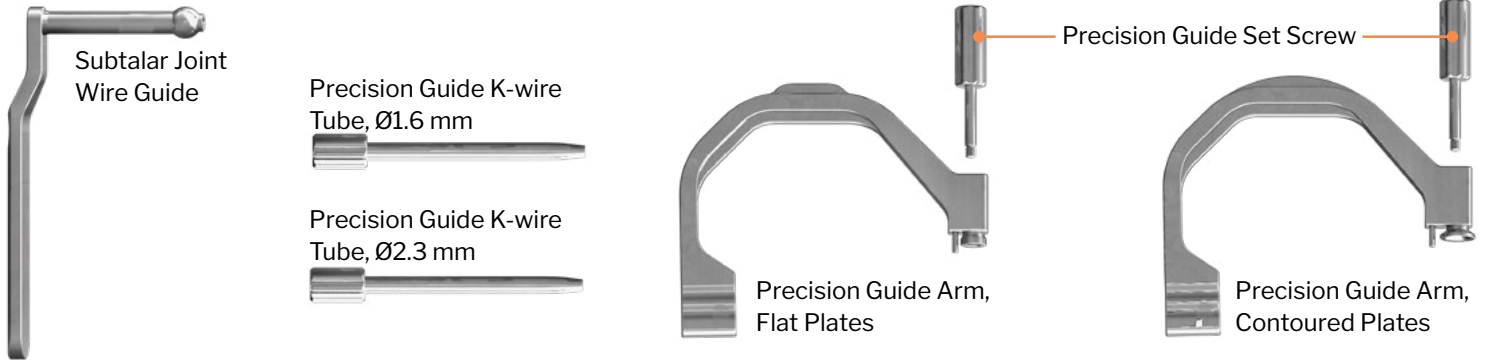

Anterior Mini-Open Instrumentation

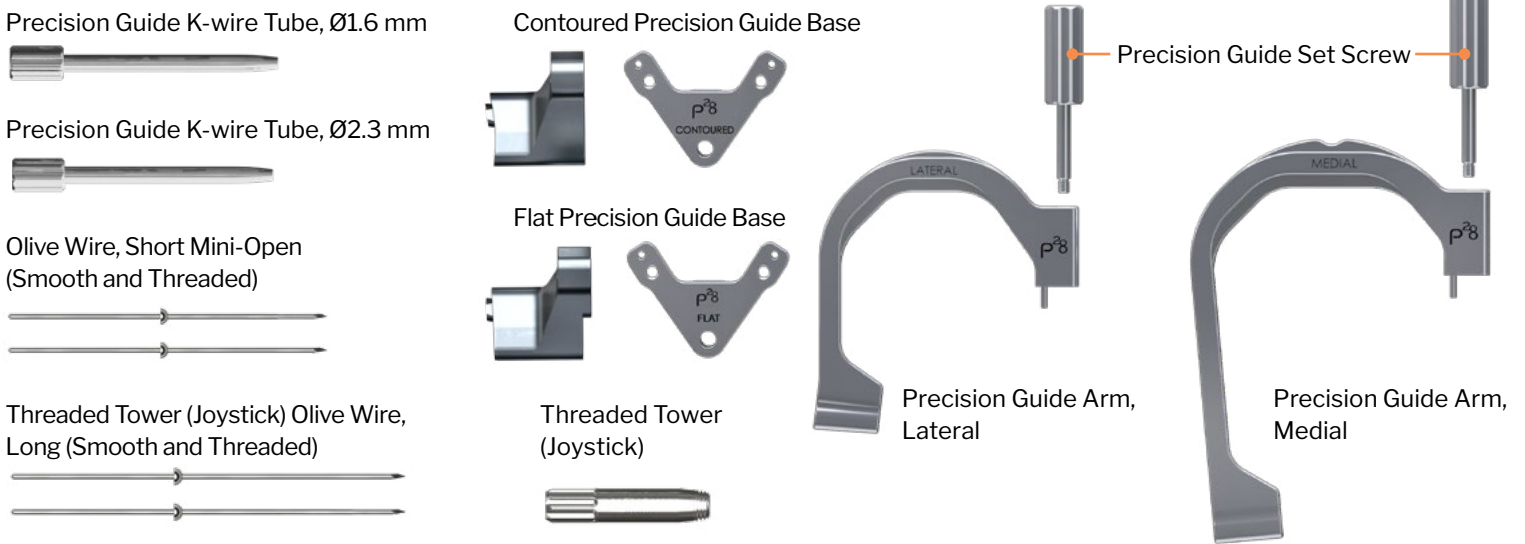

Lateral TT/TTC Precision Guide

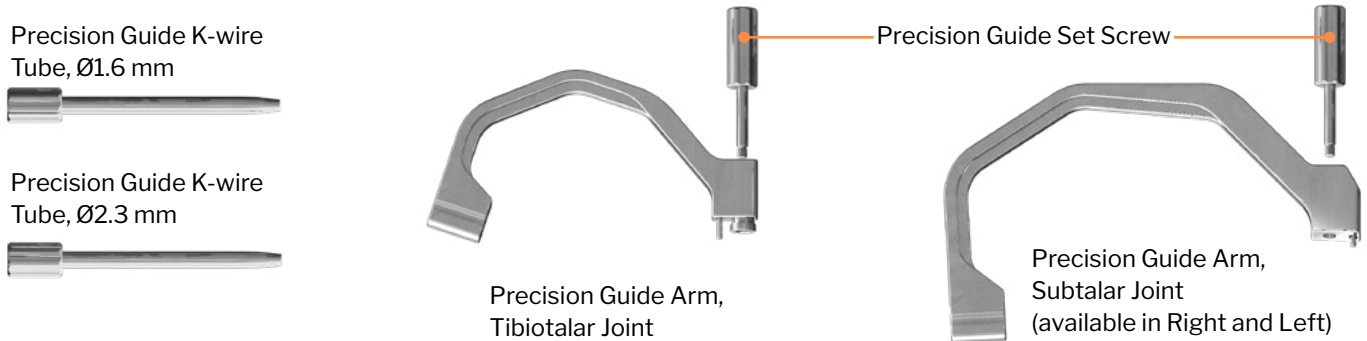

Posterior Precision Guides

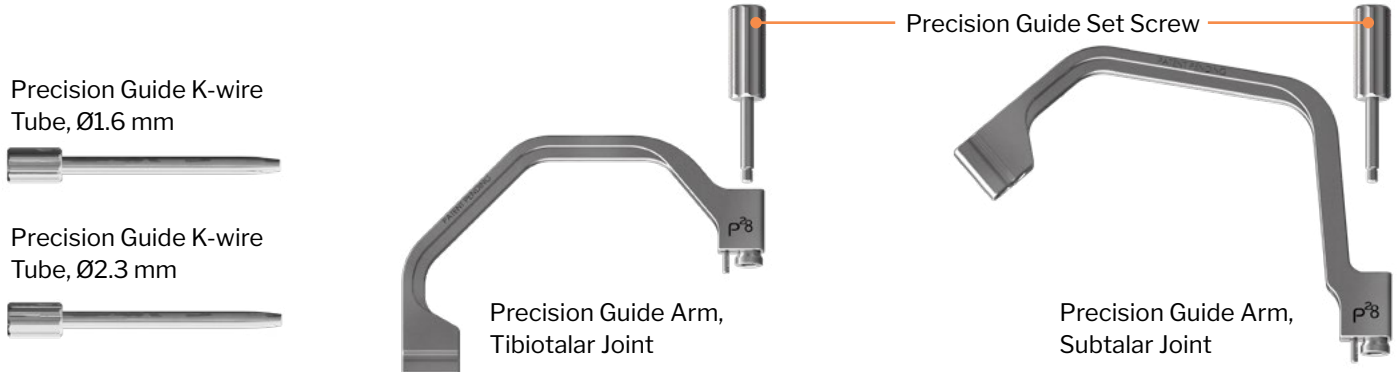

INCISION/EXPOSURE

TIBIOTALAR JOINT

A longitudinal midline incision is made over the anterior ankle, beginning approximately 10 cm proximal to the ankle joint and terminating just distal to the talonavicular joint. The incision will start approximately 1 cm lateral to the tibial crest and will course just lateral to the tibialis anterior (TA) tendon. The initial incision should penetrate skin only, but no direct tension should be placed on the skin margins until full-thickness retraction is possible. Identify the superficial peroneal nerve and retract it laterally. Continue exposure to the extensor retinaculum. Identify the extensor hallucis longus (EHL) tendon below the retinaculum and divide the retinaculum longitudinally over the EHL tendon. Care should be taken to leave the sheath of the TA tendon intact and the retinaculum well preserved for repair at closure.



Retract the EHL tendon laterally and the TA tendon medially. Identify the neurovascular bundle and retract it laterally with the EHL tendon. Continue exposure until the anterior capsule is visualized. Perform an anterior capsulotomy via a longitudinal incision. Elevate the capsule and periosteum over the anterior tibia and talus to expose the anterior ankle joint, the tibial plafond, the medial and lateral gutters and the anterior and dorsal talus. Remove any osteophytes on the tibia and talus to allow for exposure to the ankle joint and facilitate entry of instrumentation for cartilage removal. All osteophytes must be removed from the anterior ankle to facilitate application of the plate.

JOINT PREPARATION

Preparation of the tibiotalar joint can be performed using the provided joint preparation instrumentation. A Hindfoot Distractor is offered to allow for space and visualization during joint preparation, to be used with the Ø2.5 mm K-wires. The Hindfoot Distractor and K-wires are placed through the lateral aspect of the incision with appropriate soft tissue retraction, in an anterior to posterior direction. Following cartilage removal, it is advised to penetrate the subchondral plate with the Subchondral Drill, Burrs and/or Bone Fenestration Chisels to promote healing.

PROVISIONAL FIXATION

Align the ankle joint. The foot and ankle should be positioned such that the ankle is neutral with respect to dorsiflexion and plantarflexion. The foot should be in approximately 5-10° of external rotation and 5° of hindfoot valgus. With the foot and ankle held in this alignment, use one or two Ø2.0 mm K-wires to temporarily fixate the tibiotalar joint, per surgeon preference.



PLATE PLACEMENT



Frequently there is an irregular surface remaining over the anterior joint which requires debridement to a smooth surface with either a rongeur or saw. Retrieve the appropriate anterior TT plate based on the patient's anatomy. To position the plate, palpate the medial and lateral margins of the talus and center the talar portion of the plate. Ensure that the proximal plate is midline or just lateral to midline.

Secure the plate to the tibiotalar joint using a long Olive Wire in the most proximal circular hole on the tibia and a short Olive Wire in the medial talar neck screw hole. Confirm plate position using fluoroscopy.

PERMANENT FIXATION - PLATE SCREWS



NOTE: The talar screw holes accept Ø3.5 mm or Ø4.2 mm non-locking and locking screws. Ø4.2 mm screws are recommended for this area, except in the case of a small patient. The use of Ø4.2 mm screws is demonstrated in this technique. When using Ø3.5 mm screws, use the appropriate instrumentation as described on page 4.



Retrieve the Ø4.2 mm Locking Drill Guide and thread into the lateral talar body screw hole. Drill, using the Ø2.8 mm Drill.



Remove the Ø4.2 mm Locking Drill Guide and measure screw length using the Depth Gauge. Confirm screw projection and length using the Depth Gauge under fluoroscopy (not shown). Insert the selected screw size into the plate hole using the provided Driver and Handle. Do not fully tighten screw until the second talar screw is secure, to prevent toggling of the plate.



Remove the Olive Wire in the talar neck hole. Insert a second Ø4.2 mm screw into the medial talar body hole using the same procedure previously described. Complete tightening and seating of both talar body screws.

PERMANENT FIXATION - TIBIAL COMPRESSION SCREW

NOTE: The tibial screw holes accept Ø4.5 mm, Ø4.7 mm, or Ø5.2 mm locking or non-locking screws. A laser etched dot on the plate indicates the plate holes that accept the Ø4.5 mm, Ø4.7 mm, and Ø5.2 mm screws. The technique demonstrates the use of the Ø4.5 mm screws. When using the Ø4.7 mm or Ø5.2 mm screws, use the appropriate instrumentation as described on page 4.



Retrieve the Ø4.5 mm oblong Compression Slot Drill Guide and insert into the tibial compression slot with the arrow pointing towards the tibiotalar joint. Drill, using a Ø3.1 mm Drill through the Compression Slot Drill Guide.

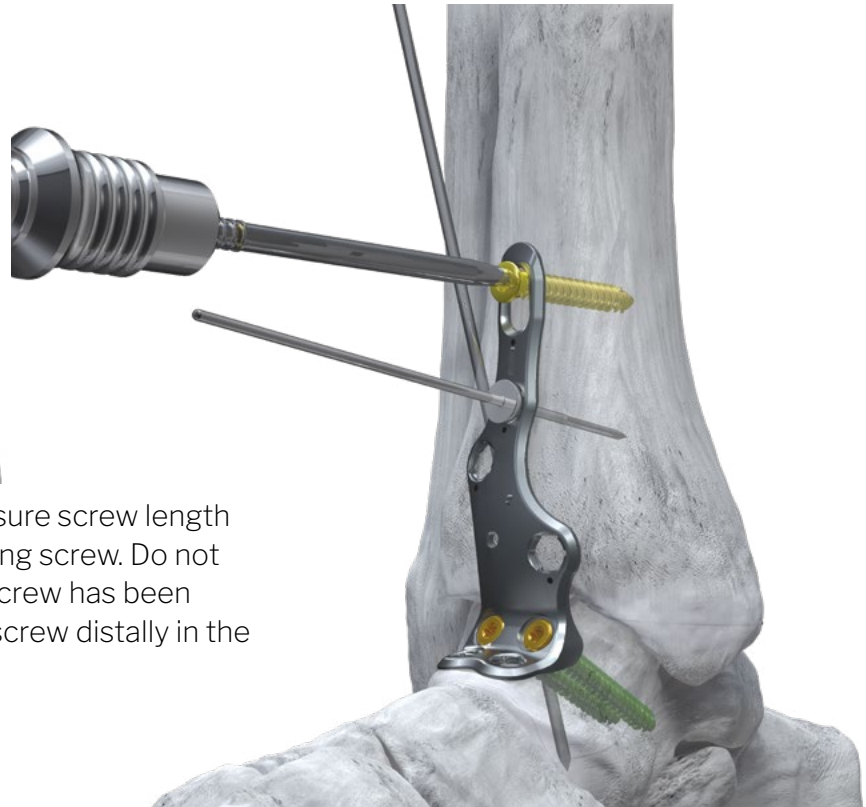

Remove the Compression Slot Drill Guide and measure screw length using the Depth Gauge. Insert a Ø4.5 mm non-locking screw. Do not fully tighten the screw until the tibiotalar crossing screw has been inserted. This allows for travel of the compression screw distally in the slot during final tightening of the crossing screw.

PERMANENT FIXATION - PRECISION GUIDED CROSSING SCREW

Retrieve the corresponding anterior TT Precision Guide and Set Screw. Insert the provided Set Screw into the hole adjacent to the boss on the undersurface of the Precision Guide Arm.

Align the boss on the underside of the Precision Guide into the smaller of the two central holes on the ankle fusion plate to correctly orient the Precision Guide, while aligning the Set Screw over the larger of the two central holes. Rotate the Set Screw clockwise to secure the Precision Guide to the ankle fusion plate.

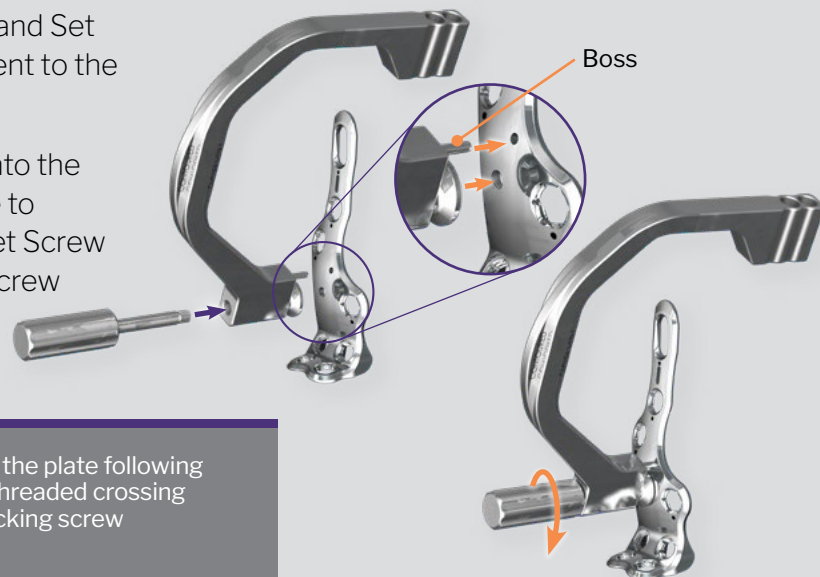

NOTE: Alternatively, the Precision Guide can be placed on the plate following completion of plate fixation to bone. Placement of a fully threaded crossing screw would take place after fully seating the tibial non-locking screw in the compression slot.

PERMANENT FIXATION - PRECISION GUIDED CROSSING SCREW



 **NOTE:** K-wire Tubes for the Precision Guide are available in Ø1.6 mm and Ø2.3 mm, allowing for Ø5.5 mm or Ø7.0 mm Monster Screws to be used. Partially threaded and fully threaded screw options are available for each screw diameter, per surgeon preference. The use of Ø7.0 mm Monster Screw is demonstrated in this technique. When using the Ø5.5 mm Monster Screw, use the corresponding instrumentation for that diameter screw.



Retrieve the Ø2.3 mm K-wire for a Ø7.0 mm partially threaded Monster Screw. Insert the K-wire through the K-wire Tube and across the arthrodesis site.

Confirm crossing screw trajectory using fluoroscopy. The ideal position for the trajectory is terminating just proximal to the lateral process of the talus.



Remove the K-wire sleeve from the Ø2.3 mm K-wire. Remove the Precision Guide by turning the Set Screw counterclockwise to detach the Precision Guide from the plate. Remove the Precision Guide and slide the K-wire Tube off the K-wire.



Retrieve the Countersink for the Ø7.0 mm headed Monster Screw. Rotate the Countersink clockwise over the K-wire to remove adequate bone to seat the screw head. Measure screw length using the Depth Gauge (not shown).

 **NOTE:** If soft bone is apparent, it is advised not to countersink in this area to allow for better screw purchase. Monster Screw washers are available; however, the steep screw angle may cause prominence of the washer.

 **TIP:** If minimal compression or poor bone purchase occurs with this crossing screw, remove the partially threaded screw and guide wire. Obtain compression by fully tightening the non-locking screw in the compression slot and then place a fully threaded screw via the Precision Guide.

PERMANENT FIXATION - PRECISION GUIDED CROSSING SCREW



Drill over the K-wire using the Ø4.6 mm Drill for the Ø7.0 mm headed Monster Screw.

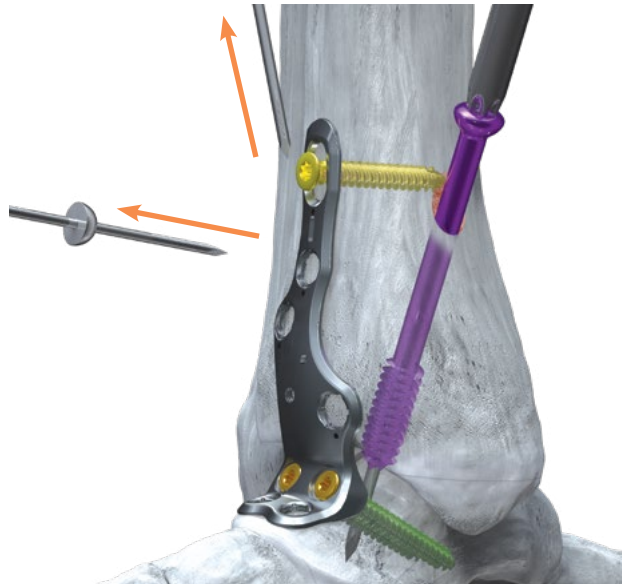

Insert a Ø7.0 mm headed Monster Screw using the provided Driver. Prior to seating the Monster Screw head against bone, remove the Olive Wire from the tibial screw hole and the provisional fixation across the tibiotalar joint. Fully seat the Monster Screw, then confirm screw length and placement using fluoroscopy. Remove the Ø2.3 mm K-wire.



Fully seat the non-locking screw in the tibia compression slot.

PERMANENT FIXATION - PLATE SCREWS



Insert two Ø4.2 mm screws into the talar neck holes using the same procedure previously described.



Insert the remaining tibial screws using the technique previously described for Ø4.5 mm screws. Confirm screw lengths and placement using fluoroscopy.

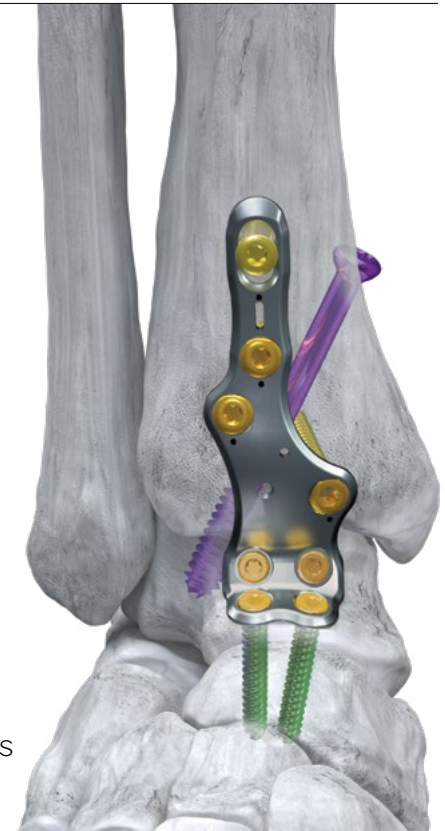

CLOSURE

Proceed to incision closure or concomitant procedures at this time.

INCISION/EXPOSURE

TIBIOTALAR JOINT

An incision for the tibiotalar joint is made as described on page 7 for the anterior TT arthrodesis surgical technique.

SUBTALAR JOINT

A longitudinal incision is made starting at the distal aspect of the lateral malleolus over the subtalar joint extending toward the 4th metatarsal base and terminating at the calcaneocuboid joint. Continue exposure through the subcutaneous tissue, with care being taken to identify and retract the anterior branch of the sural nerve. The extensor hallucis brevis muscle is reflected distally to expose the sinus tarsi and posterior facet of the subtalar joint. Dissection of the fat pad out of the sinus tarsi should be performed, with reflection of the tissue dorsally.

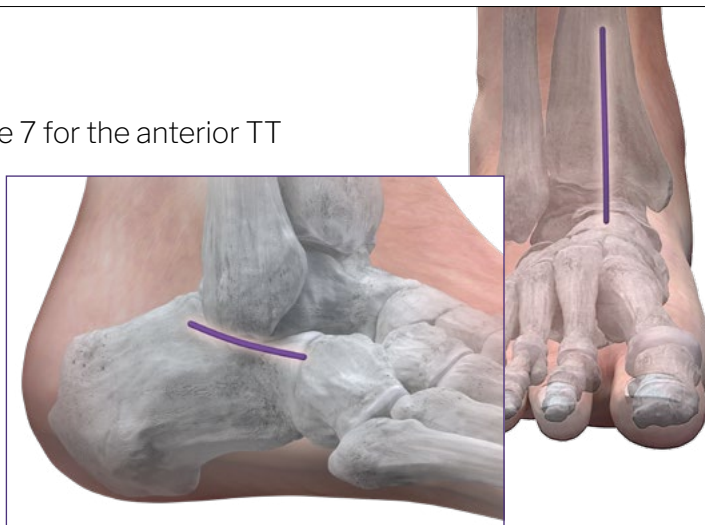

JOINT PREPARATION

Preparation of the tibiotalar joint can be performed using the provided joint preparation instrumentation. The medial and lateral gutters should be cleared at this time. Remove cartilage from the posterior, middle and anterior facets of the subtalar joint. A Hindfoot Distractor is provided to allow for space and visualization during joint preparation, to be used with provided Ø2.5 mm K-wires. It is advised to penetrate the subchondral plate with the Subchondral Drill, Burrs and/or Chisels to promote healing.

PROVISIONAL FIXATION

Align the ankle joint. The foot and ankle should be positioned such that the ankle is neutral with respect to dorsiflexion and plantarflexion. The foot should be in approximately 5-10° of external rotation and 5° of hindfoot valgus. With the foot and ankle held in this alignment, use Ø2.0 mm K-wires to temporarily fixate the tibiotalar joint and subtalar joint, per surgeon preference.



PLATE POSITIONING



Resection of osteophytes or prominent bone may be necessary to ensure proper plate fit. Retrieve the appropriate anterior TTC plate based on the patient's anatomy.

To position the plate, palpate the medial and lateral margins of the talus and center the talar portion of the plate. Ensure that the proximal plate is midline or just lateral to midline.

Secure the plate to the tibiotalar joint using a long Olive Wire in the most proximal circular hole on the tibia and a short Olive Wire in the medial talar neck screw hole. Confirm plate position using fluoroscopy.

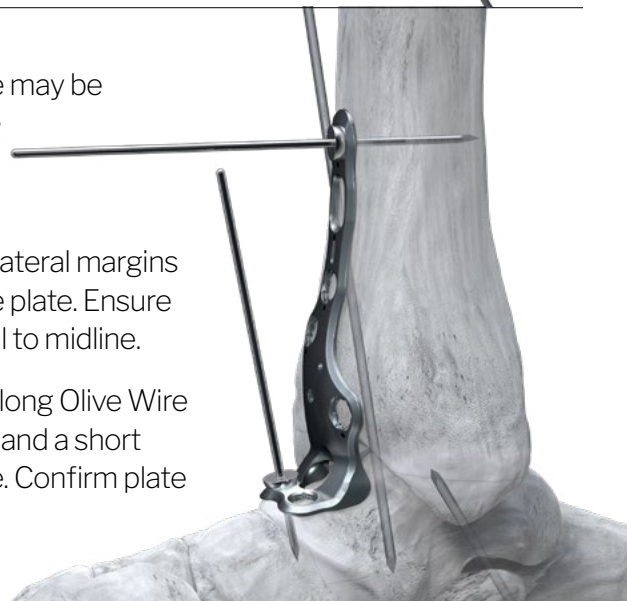

PERMANENT FIXATION – TALAR NECK AND TIBIAL COMPRESSION SCREWS

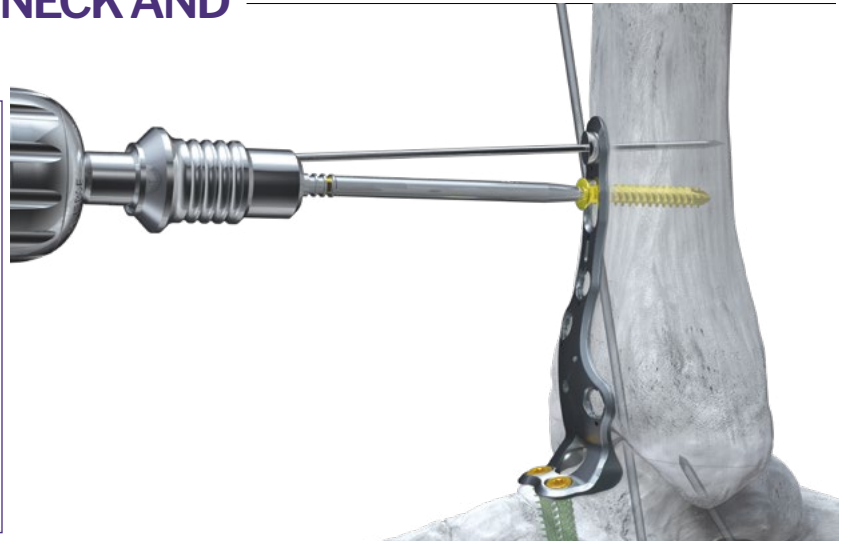

Insert talar neck screws as described on page 8. Insert the tibial compression screw as described on page 9.

PERMANENT FIXATION – TALAR NECK AND TIBIAL SCREWS

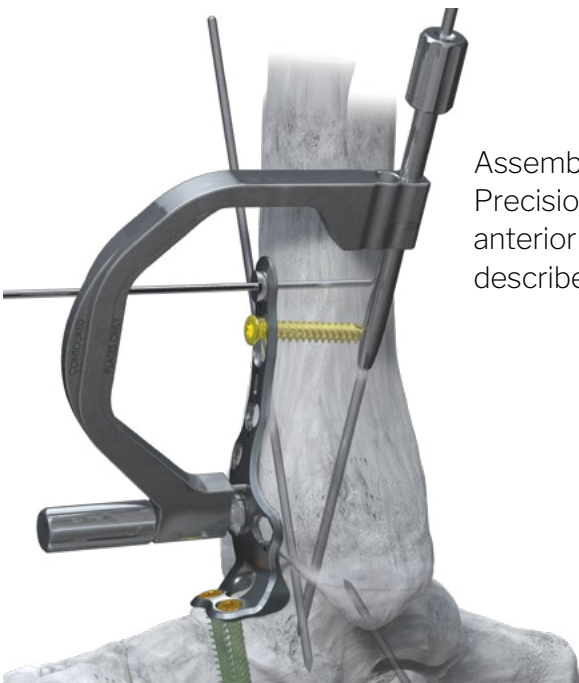

Assemble and attach the Precision Guide to the anterior TTC plate as described on page 9.

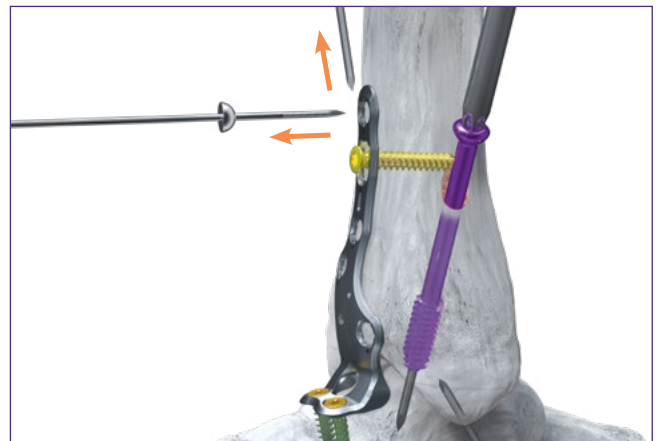

Insert the tibiotalar crossing screw as described on page 10 and 11. Prior to seating the Monster Screw head against bone, remove the Olive Wire from the tibial screw hole and the provisional fixation across the tibiotalar joint. Fully seat the Monster Screw, then confirm screw length and placement using fluoroscopy. Remove the Ø2.3 mm K-wire.

PERMANENT FIXATION – TIBIAL SCREWS



Insert tibial screws as described on page 11.

PERMANENT FIXATION – SUBTALAR JOINT CROSSING SCREW

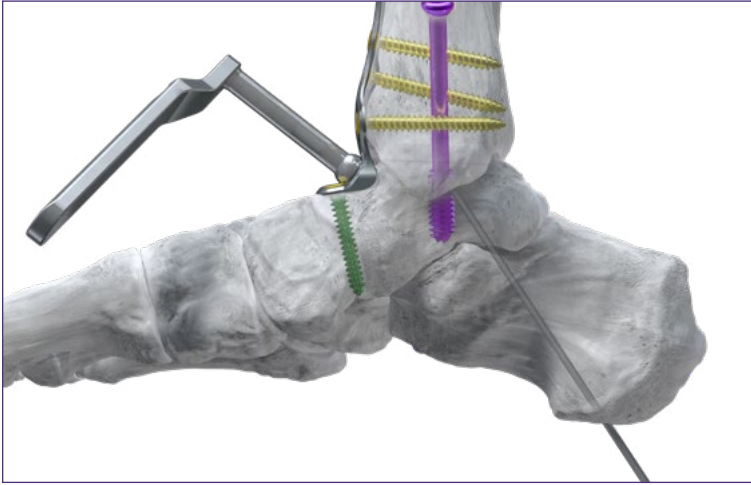

A Ø7.0 headed Monster Screw is used in this plate hole. Retrieve the Subtalar Joint Wire Guide for a Ø7.0 mm headed Monster Screw. Mate the tip of the Wire Guide into the socket of the plate.



Insert a Ø2.3 mm K-wire through the Wire Guide across the subtalar joint, aiming for the central posterior aspect of the calcaneus, just above the weight bearing surface.

Remove the K-wire serving as provisional fixation across the subtalar joint.

Measure screw length using the cannulated Depth Gauge.

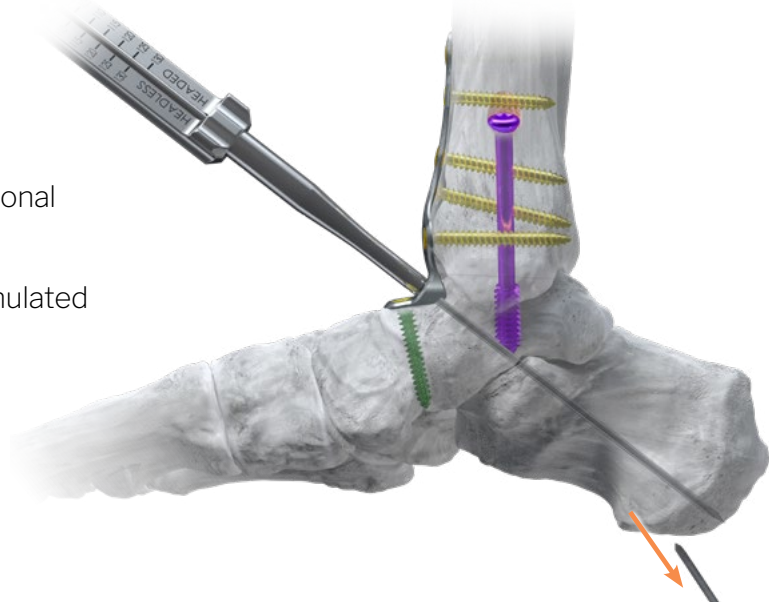

Drive the Ø2.3 mm K-wire posteriorly until it exits the skin. Retrieve a Parallel K-wire Guide from the Monster Screw System instrument caddy. Slide the central, isolated hole of the Parallel K-wire Guide over the Ø2.3 mm K-wire.



Depending on screw type used (headed vs. headless), place a second Ø2.3 mm K-wire a desired distance proximal to the initial Ø2.3 mm K-wire.

PERMANENT FIXATION – SUBTALAR JOINT CROSSING SCREW



NOTE: A partially threaded screw is recommended to be placed in the more proximal position, to allow for the threads of the screw to engage the denser bone in the talus and create compression across the subtalar joint. The second screw placed in the plate is intended to be a fully threaded screw to hold in the compression created from the first screw.

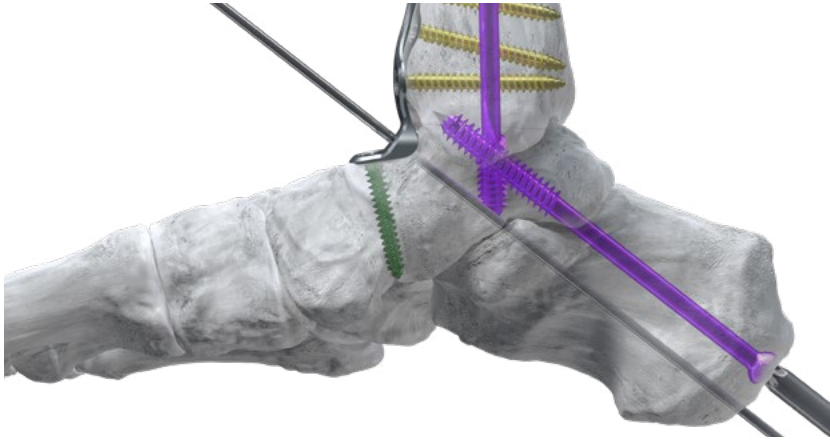

Placement of a partially threaded $\varnothing 7.0$ mm Monster Screw through the posterior calcaneus into the talus is performed as described on pages 10 and 11. Remove the $\varnothing 2.3$ mm K-wire. Confirm screw placement using fluoroscopy.

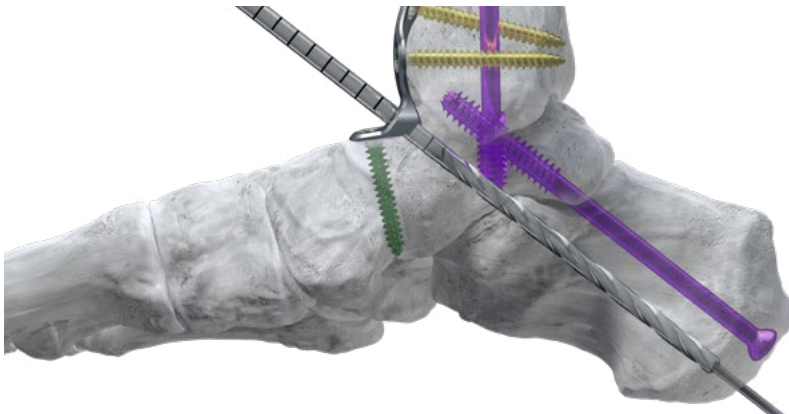

NOTE: Countersinking is not necessary, as the $\varnothing 7.0$ mm Monster Screw is seated within the plate.

Drill over the K-wire using the $\varnothing 4.6$ mm Drill for the $\varnothing 7.0$ mm headed Monster Screw.

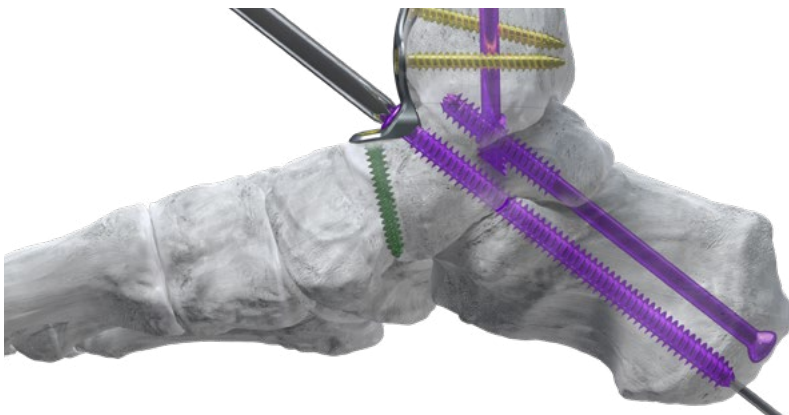

Insert a $\varnothing 7.0$ mm headed, fully threaded Monster Screw using the provided Driver.

Confirm screw length and placement using fluoroscopy. Remove the $\varnothing 2.3$ mm K-wire.

CLOSURE

Proceed to incision closure or concomitant procedures at this time.

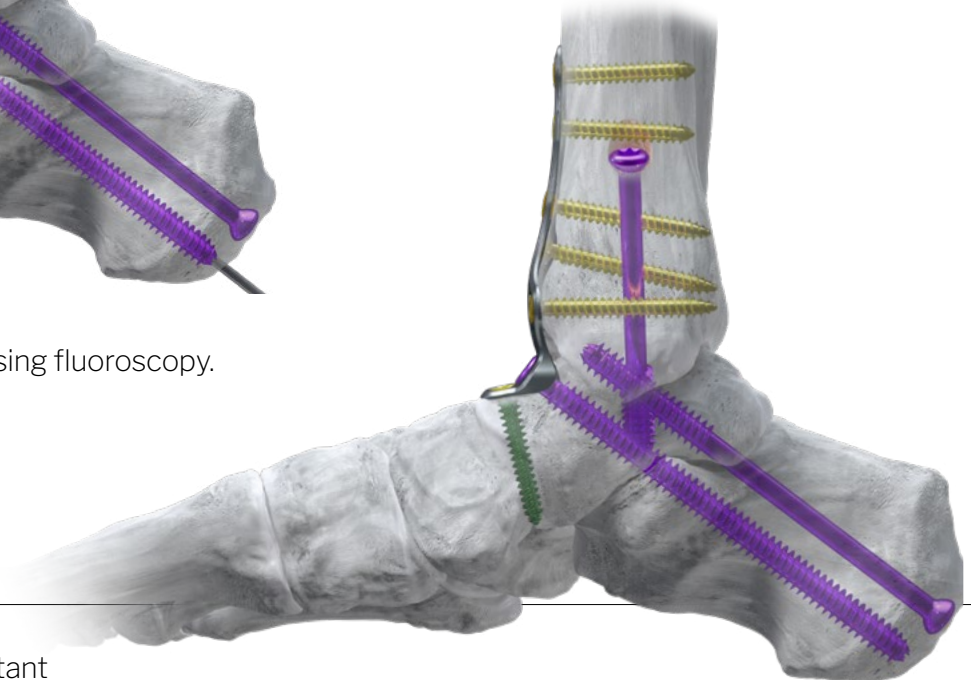

INCISION/EXPOSURE

A longitudinal midline incision is made over the anterior ankle, beginning approximately 2 cm proximal to the tibiotalar joint, and terminating just distal to the talonavicular joint. The incision will start approximately 1 cm lateral to the tibial crest and will course just lateral to the tibialis anterior (TA) tendon. The initial incision should penetrate skin only, but no direct tension should be placed on the skin margins until full-thickness retraction is possible. Identify the superficial peroneal nerve and retract it laterally. Continue exposure to the extensor retinaculum. Identify the extensor hallucis longus (EHL) tendon below the retinaculum and divide the retinaculum longitudinally over the EHL tendon. Care should be taken to leave the sheath of the TA tendon intact and the retinaculum well preserved for repair at closure.

Retract the EHL tendon laterally and the TA tendon medially. Identify the neurovascular bundle and retract it laterally with the EHL tendon. Continue exposure until the anterior capsule is visualized. Perform an anterior capsulotomy via a longitudinal incision. Elevate the capsule and periosteum over the anterior tibia and talus to expose the anterior ankle joint, the tibial plafond, the medial and lateral gutters and the anterior and dorsal talus.

Remove any osteophytes on the tibia and talus to allow for exposure to the ankle joint and facilitate entry of instrumentation for cartilage removal. All osteophytes must be removed from the anterior ankle to facilitate application of the plate.



JOINT PREPARATION

Preparation of the tibiotalar joint can be performed using the provided joint preparation instrumentation. A Hindfoot Distractor is offered to allow for space and visualization during joint preparation, to be used with the Ø2.5 mm K-wires. The Hindfoot Distractor and K-wires are placed through the lateral aspect of the incision with appropriate soft tissue retraction, in an anterior to posterior direction. Following cartilage removal, it is advised to penetrate the subchondral plate with the Subchondral Drill, Burrs and/or Bone Fenestration Chisels to promote healing. Alternatively, the ankle joint may be prepared using arthroscopic instrumentation per surgeon preference.

PROVISIONAL FIXATION

Align the ankle joint. The foot and ankle should be positioned such that the ankle is neutral with respect to dorsiflexion and plantarflexion. The foot should be in approximately 5-10° of external rotation and 5° of hindfoot valgus. With the foot and ankle held in this alignment, place a 2.0 mm K-wire lateral to medial for temporary fixation the tibiotalar joint.

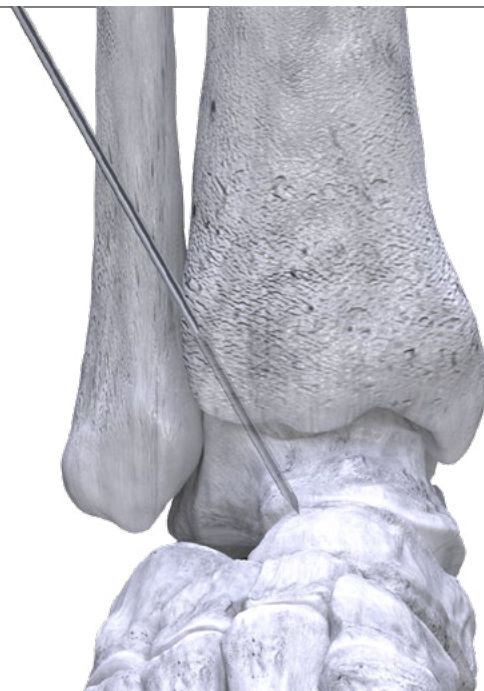
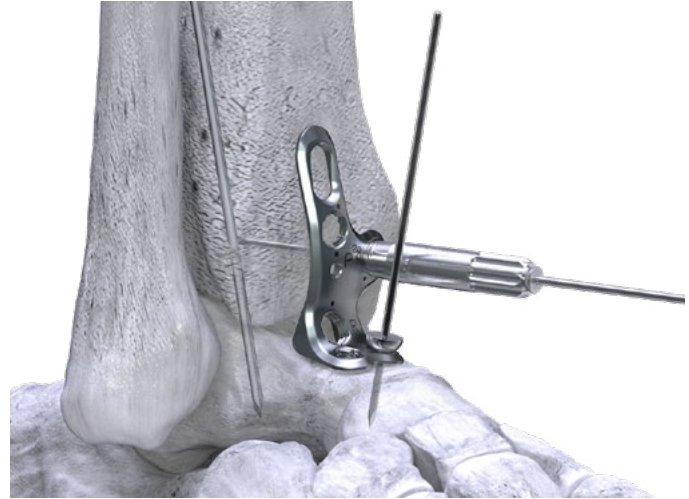

PLATE POSITIONING AND PROVISIONAL FIXATION



Prior to the temporary fixation of the plate, thread the Threaded Tower (Joystick) through the medial tibial screw hole (as shown) to aid in plate positioning. To position the plate, palpate the medial and lateral margins of the talus and center the talar portion of the plate. Ensure that the proximal plate is midline or just lateral to midline.



Secure the plate to the tibiotalar joint by placing a Long Olive Wire from the Anterior Mini-Open Plate Caddy through the Threaded Tower (Joystick) in the medial tibial screw hole and an Olive Wire from the Silverback K-wire and Olive Wire Caddy in the medial talar neck screw hole. Confirm plate position using fluoroscopy.

PERMANENT FIXATION – PLATE SCREWS



NOTE: The talar body screw holes accept Ø4.5 mm, Ø4.7 mm, or Ø5.2 mm locking or non-locking screws. A laser etched dot on the plate indicates the plate holes that accept Ø4.5 mm, Ø4.7 mm, and Ø5.2 mm screws. The technique demonstrates the use of the Ø4.5 mm screws. When using the Ø4.7 mm or Ø5.2 mm screws, use the appropriate instrumentation as described on page 4. The appropriate Locking Drill Guide is recommended for all tibia screws and the talar body screw to achieve on-axis trajectory and avoid interference with the crossing screws.



Retrieve the Ø4.5 mm Threaded Drill Guide and thread into the talar body screw hole. Drill, using the Ø3.1 mm Drill.

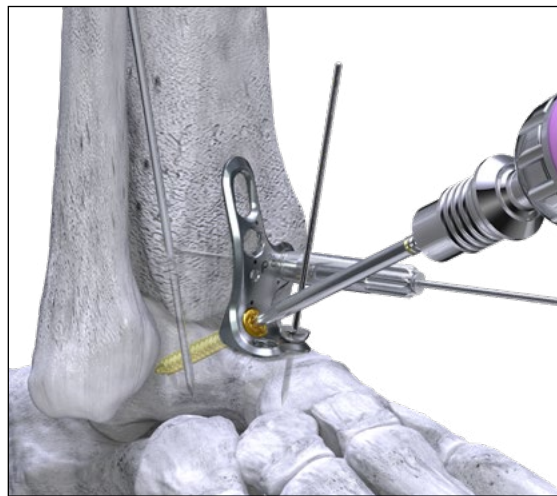

Remove the Ø4.5 mm Threaded Drill Guide and measure screw length using the Depth Gauge (not shown). Confirm screw projection and length using the Depth Gauge under fluoroscopy. Insert and fully seat the selected talar body screw into the plate hole using the provided Driver and Handle.



Remove the Olive Wire in the talar neck hole. Do not remove the Olive Wire from the Threaded Tower (Joystick) of the tibia to prevent shifting of the plate.

PERMANENT FIXATION – TIBIAL COMPRESSION SCREW



NOTE: The tibial screw holes accept Ø4.5 mm Ø4.7 mm, or Ø5.2 mm locking or non-locking screws. A laser etched dot on the plate indicates the plate holes that accept Ø4.5 mm, Ø4.7 mm, and Ø5.2 mm screws. The technique demonstrates the use of the Ø4.5 mm screws. When using the Ø4.7 mm or Ø5.2 mm screws, use the appropriate instrumentation as described on page 4. The appropriate Locking Drill Guide is recommended for all tibia screws and the talar body screw to achieve on-axis trajectory and avoid interference with the crossing screws.

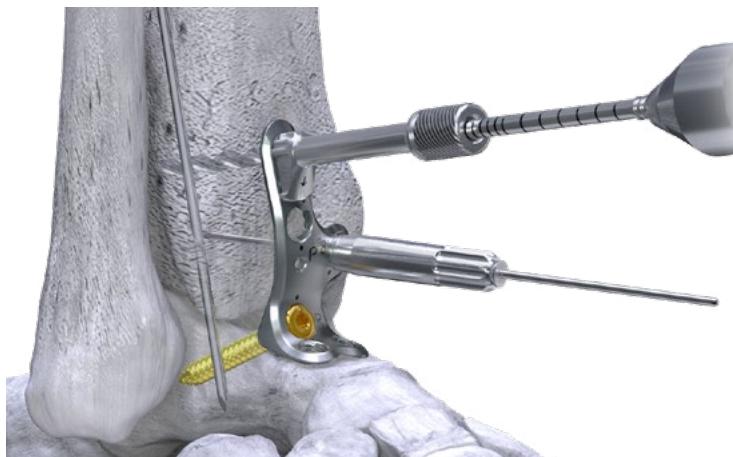

Retrieve the Ø4.5 mm oblong Compression Slot Drill Guide and insert into the tibial compression slot with the arrow pointing towards the tibiotalar joint. Drill, using a Ø3.1 mm Drill through the Compression Slot Drill Guide.

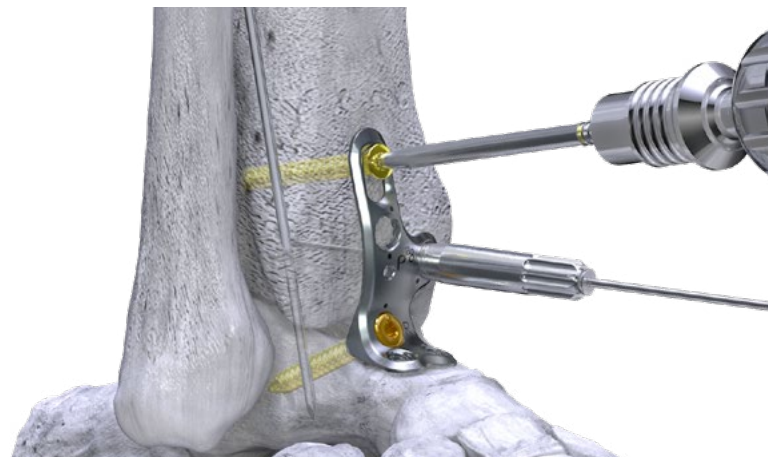

Remove the Compression Slot Drill Guide and measure screw length using the Depth Gauge. Insert a Ø4.5 mm non-locking screw. Do not fully tighten the screw until the medial tibiotalar crossing screw has been inserted. This allows for travel of the compression screw distally in the slot during final tightening of the crossing screw. Remove the Long Olive Wire from the tibia to allow for removal of the Threaded Tower (Joystick) at this time.

PERMANENT FIXATION - PRECISION GUIDED CROSSING SCREWS

Prior to the placement of the Precision Guide Base on to the plate, attach the Medial Precision Guide Arm to the Precision Guide Arm Base. Align the pin of the Medial Precision Guide Arm with the proximal hole located on the medial side of the Precision Guide Base. Secure the Guide Arm to the Arm Base by turning the set screw clockwise.

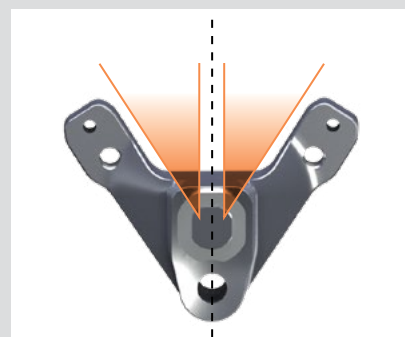
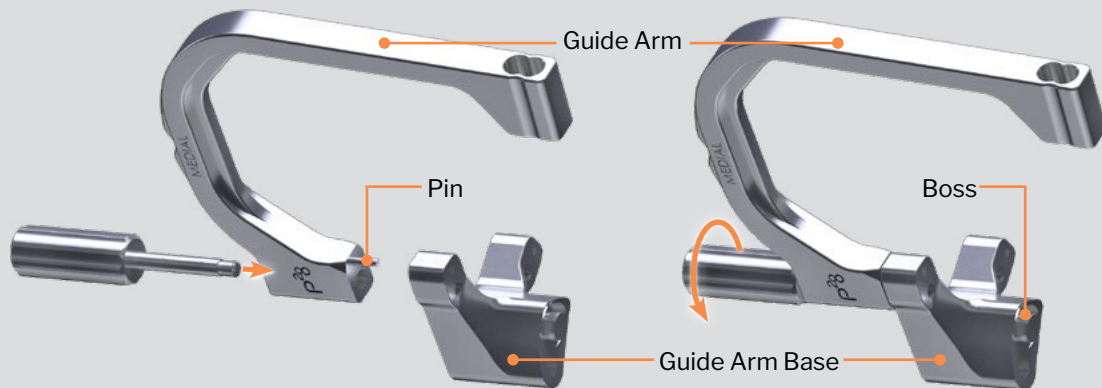

The Precision Guide Base is universal for right and left sides and is symmetric about its mid-line. The Medial and Lateral Precision Guide Arms will drive the trajectory of the guide wire for the crossing screw.



NOTE: The Medial Precision Guide Arm is labeled using laser etching and has a small notch on the top ridge of the guide. This technique demonstrates the use of a right foot.

PERMANENT FIXATION - PRECISION GUIDED CROSSING SCREWS

After connecting the Medial Precision Guide Arm to the Precision Guide Base, the Arm Base inserts into the plate through two holes. Align the boss on the underside of the Precision Guide Base with the tibia screw hole located distal to the compression slot. Align the distal through-hole of the Base with the small threaded hole located in the center of the plate. A Set Screw will be used to secure the base to the plate by rotating the Set Screw clockwise.

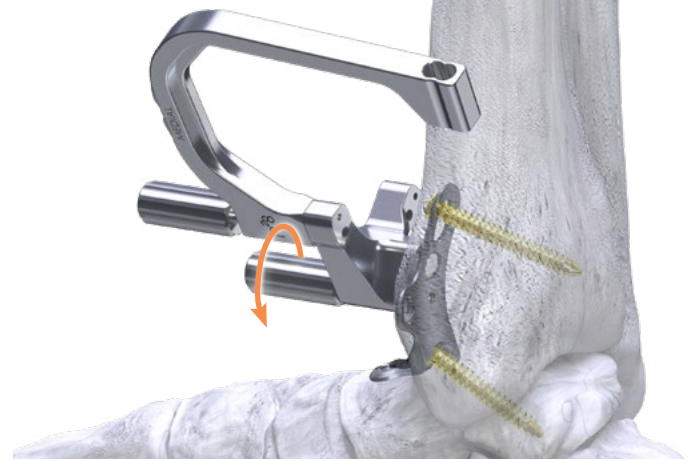
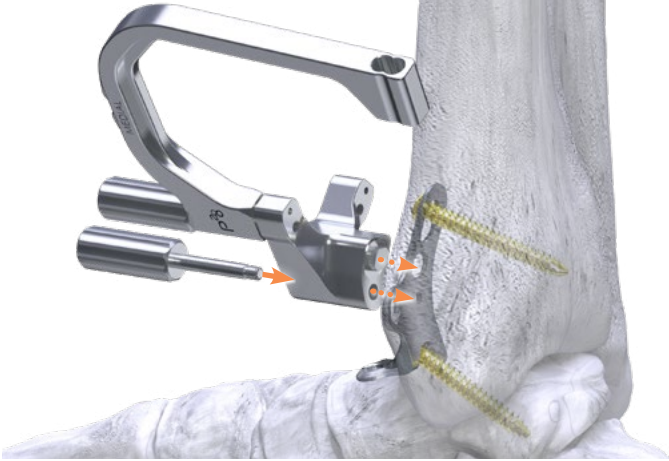

NOTE: The Medial Precision Guide Arm allows for variation anteriorly and posteriorly in the placement of the crossing screw, depending on patient size and anatomy. It is recommended to use the more posterior crossing screw trajectory, if the patient anatomy allows, for a more balanced construct.



NOTE: K-wire Sleeves for the Precision Guides are available in $\varnothing 1.6$ mm and $\varnothing 2.3$ mm, allowing for $\varnothing 5.5$ mm or $\varnothing 7.0$ mm Monster crossing screws to be used. Partially threaded and fully threaded screw options are available for each screw diameter, per surgeon preference. The use of $\varnothing 7.0$ mm Monster crossing screws are demonstrated in this technique. When using the $\varnothing 5.5$ mm Monster Screw, use the corresponding instrumentation for that diameter screw.

Place the K-wire Sleeve into the Medial Precision Guide Arm to allow placement of the $\varnothing 2.3$ mm K-wire, serving as a guide wire for the $\varnothing 7.0$ mm Monster Screw.

Place a $\varnothing 2.3$ mm K-wire through the K-wire Sleeve and insert across the tibiotalar joint.

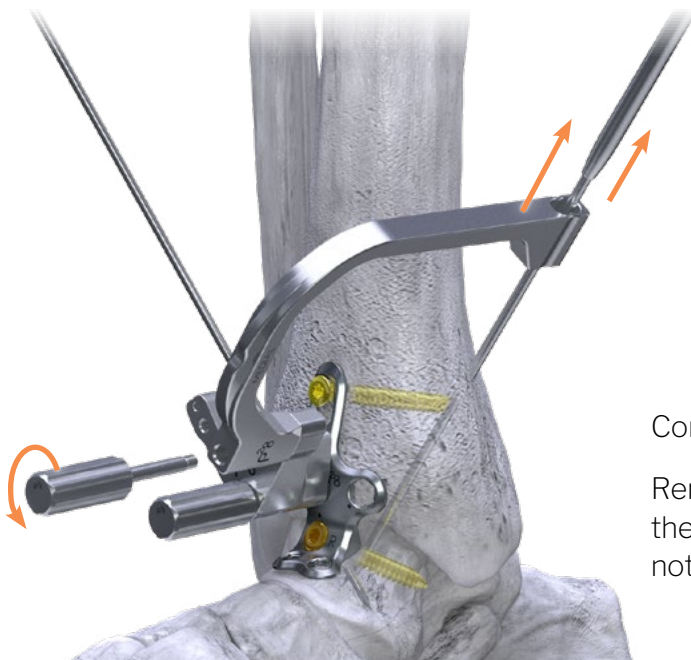
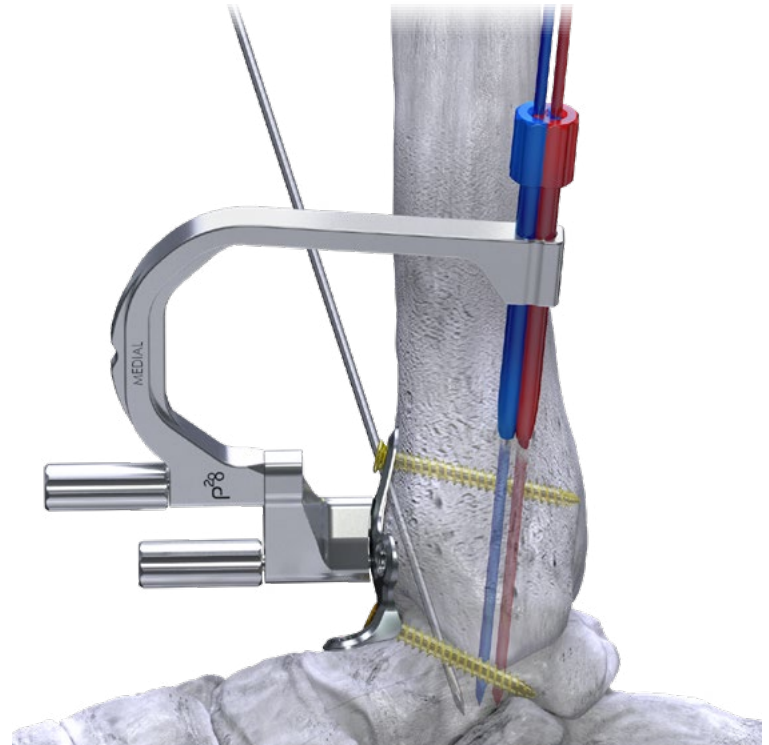

Confirm K-wire placement and trajectory using fluoroscopy.

Remove the K-wire Sleeve from the $\varnothing 2.3$ mm K-wire. Remove the Precision Guide Arm from the Precision Guide Base, but do not remove the Precision Guide Base at this time.

PERMANENT FIXATION - PRECISION GUIDED CROSSING SCREWS

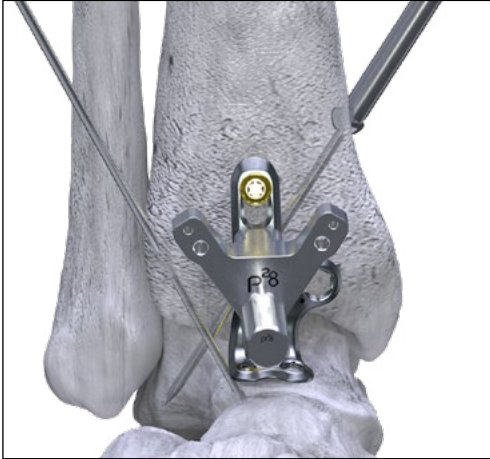

Retrieve the Countersink for the Ø7.0 mm partially threaded Monster Screw. Rotate the Countersink clockwise over the K-wire to remove adequate bone to seat the screw head. Measure screw length using the Depth Gauge (not shown).



Drill over the K-wire using the Ø4.6 mm Drill for the Ø7.0 mm partially threaded Monster Screw.

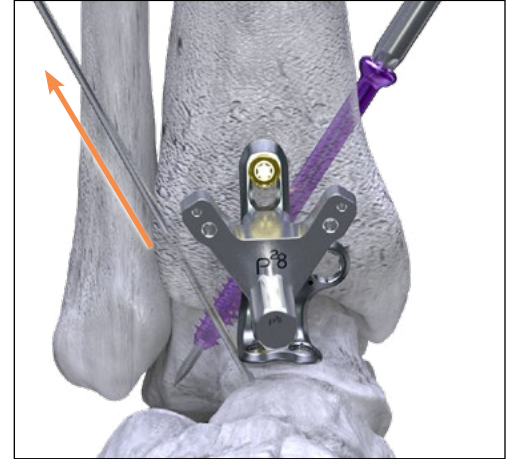

Insert, but do not fully seat the Ø7.0 mm partially threaded Monster Screw using the provided Driver. Remove the Ø2.0 mm K-wire serving as provisional fixation from the tibia before fully seating the Monster Screw.



Fully seat the Monster Screw. Confirm screw length and placement using fluoroscopy.

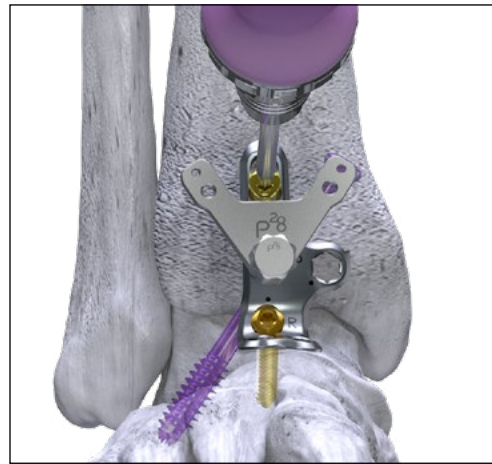

Once the Monster Screw is fully seated, use the driver for the Ø4.5 mm screws to fully seat the non-locking screw in the compression slot of the tibia.

Attach the Lateral Precision Guide Arm to the Precision Guide Base in the same manner as described for the Medial Precision Guide Arm. Repeat the process of K-wire placement that was used for the medial Monster Screw.



NOTE: The Lateral Precision Guide Arm allows for variation in anterior and posterior trajectories that converge at the medial aspect of the talus. The trajectories are biased anteriorly at the entry in the tibia to help avoid the fibula. It is recommended to use the more posterior crossing screw trajectory, if the patient anatomy allows, for a more balanced construct

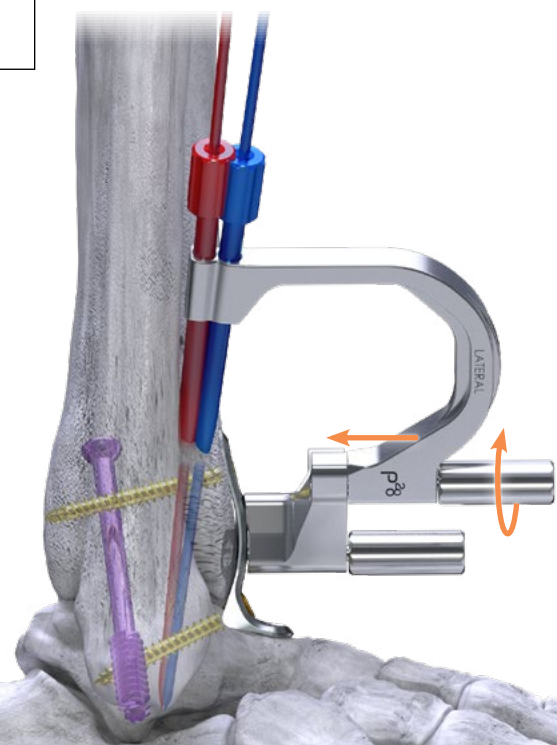

PERMANENT FIXATION - PRECISION GUIDED CROSSING SCREWS

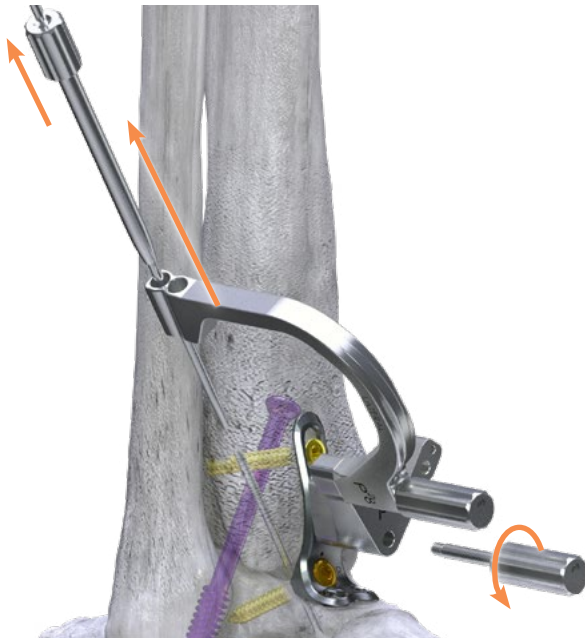

After the K-wire has been placed across the tibiotalar joint, remove the K-wire Sleeve. The Precision Guide Arm Base and the Lateral Precision Guide Arm may be removed simultaneously by turning the Precision Guide Base Set Screw counterclockwise to detach from the Mini Open plate.



Using the previous technique described on pages 19-20 for the medial partially threaded Monster Screw, place a $\text{\O}7.0$ mm fully threaded Monster Screw. Remove the $\text{\O}2.3$ mm K-wire.

PERMANENT FIXATION – PLATE SCREWS

NOTE: The talar neck screw holes accept $\text{\O}3.5$ mm or $\text{\O}4.2$ mm non-locking and locking screws. The use of $\text{\O}4.2$ mm screws is demonstrated in this technique. When using the $\text{\O}3.5$ mm screws, use the appropriate instrumentation as described on page 4.

Retrieve the $\text{\O}4.2$ mm Locking Drill Guide and thread into the lateral talar neck screw hole. Drill, using the $\text{\O}2.8$ mm Drill. Remove the $\text{\O}4.2$ mm Locking Drill Guide and measure screw length using the Depth Gauge. Confirm screw projection and length using the Depth Gauge under fluoroscopy (not shown).



PERMANENT FIXATION – PLATE SCREWS

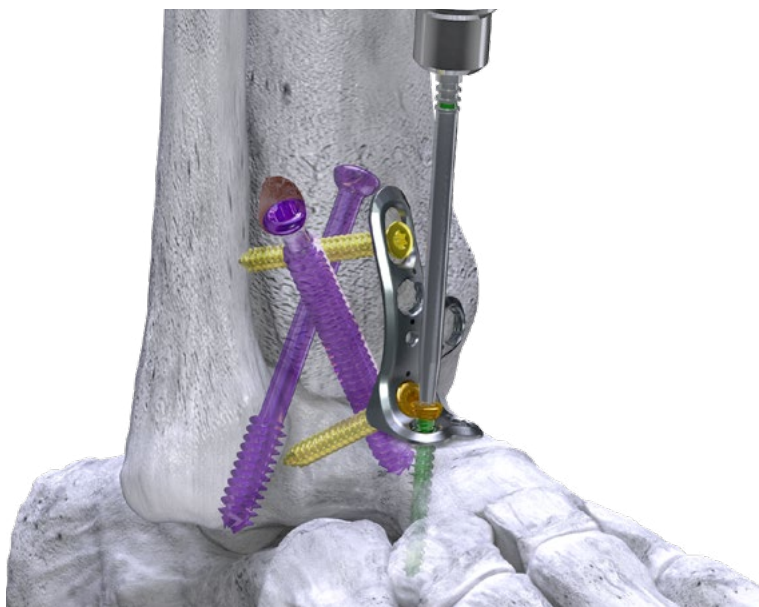

Insert the selected screw in the plate using the provided Driver and Handle. Insert the other remaining talar neck screw using the technique previously described for Ø4.2 mm screws. Confirm screw lengths and placement using fluoroscopy.

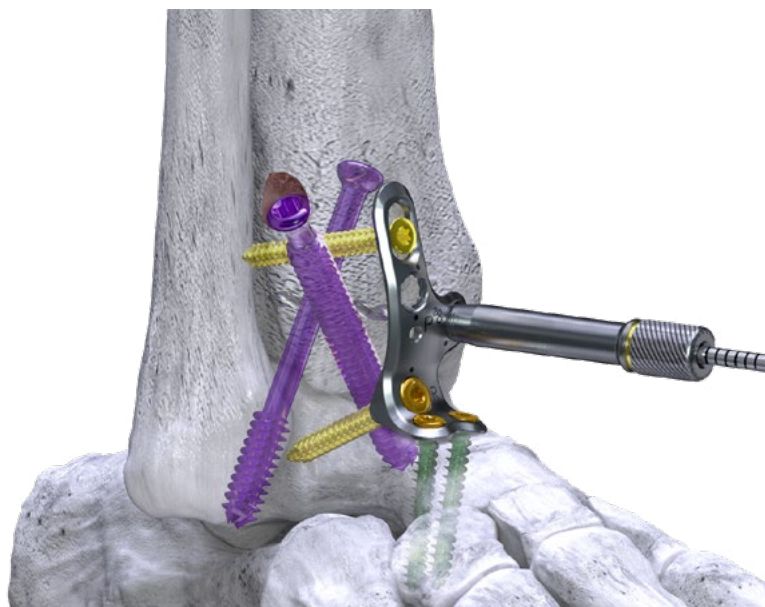

Retrieve the Ø4.5 mm Locking Drill Guide and thread into the tibial screw hole. Drill, using the Ø3.1 mm Drill. Remove the Ø4.5 mm Locking Drill Guide and measure screw length using the Depth Gauge.

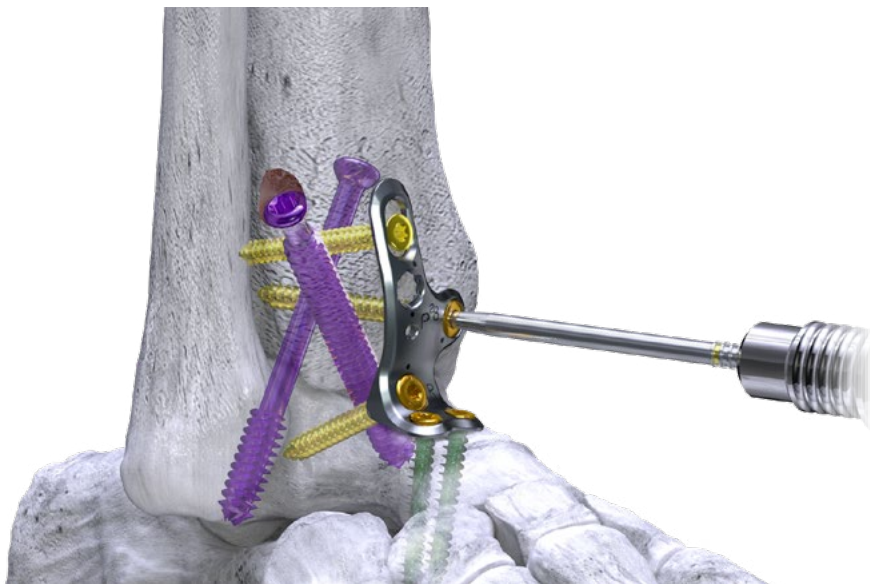

Insert the remaining tibial screws using the technique previously described for Ø4.5 mm screws. Confirm screw projection and length under fluoroscopy (not shown).



CLOSURE

Proceed to incision closure or concomitant procedures at this time.

INCISION/EXPOSURE

INCISION/EXPOSURE

A lateral incision is made over the posterior half of the fibula, beginning approximately 10 cm proximal to the tip of the fibula extending distally to the plantar aspect of the calcaneus.

Identify the sural nerve and retract it posteriorly. Continue dissection to the fibula. While retracting the peroneal tendons and sural nerve, a transverse fibular osteotomy is performed by beveling the saw from proximal lateral to distal medial to avoid a sharp bony prominence above the plate. Transect the syndesmotic and lateral ankle ligaments to free the fibula from adjacent soft tissues. Resect the fibula and retain for bone graft, if desired. Alternatively, if available, a reamer can be used to remove the fibula, while harvesting the reamed bone for graft material.

Elevate the anterior joint capsule and nearby periosteum to assess the anterior tibiotalar joint articulation. Minimal dissection of the talar neck is recommended to avoid devascularization of this bone. Remove any anterior osteophytes that may interfere with joint reduction. Elevate the posterior soft tissues using a periosteal elevator to allow for retractors to be placed anterior to and posterior to the tibiotalar joint. Elevate the extensor digitorum brevis muscle belly to expose the subtalar joint. Release the lateral ligaments around the subtalar joint including the talocalcaneal intraosseous ligament to allow for appropriate distraction. Dissect the fat pad out of the sinus tarsi to allow for appropriate visualization.



JOINT PREPARATION

Preparation of the tibiotalar joint can be performed using the provided joint preparation instrumentation. A Hindfoot Distractor is offered to allow for space and visualization during joint preparation, to be used with the Ø2.5 mm K-wires. It is advised to penetrate the subchondral plate with the Subchondral Drill, Burrs and/or Chisels to promote healing. A medial arthrotomy may be required and performed to allow for exposure and joint preparation of the medial gutter of the ankle joint.

Remove cartilage from the posterior, middle and anterior facets of the subtalar joint. Perform subchondral plate penetration to these joints to promote healing.

PROVISIONAL FIXATION

Align the ankle joint. The foot and ankle should be positioned such that the ankle is neutral with respect to dorsiflexion and plantarflexion. The foot should be in approximately 5-10° of external rotation and 5° of hindfoot valgus. With the foot and ankle held in this alignment, use multiple Ø2.0 mm K-wires to temporarily fix the tibiotalar and subtalar joints as shown. Provisional fixation wires should be placed in the anterolateral to posteromedial direction for the tibiotalar joint, and posterior to anterior direction for the subtalar joint.

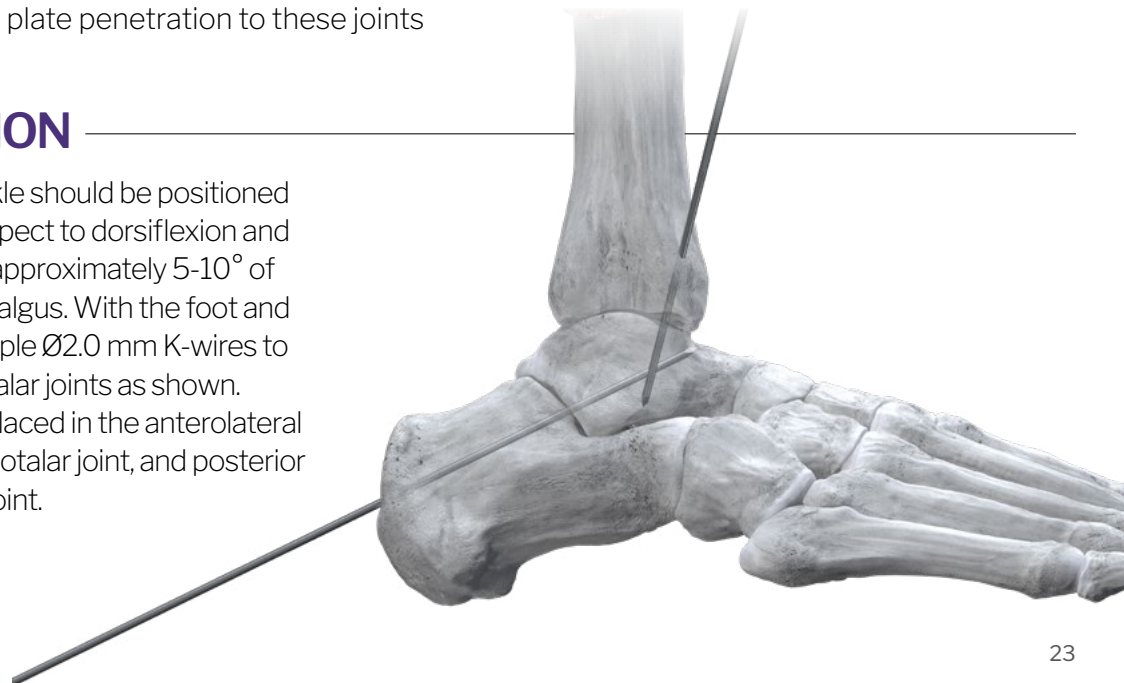

PLATE POSITIONING AND PROVISIONAL FIXATION



Resection of osteophytes or prominent bone such as the lateral talar process may be necessary to ensure proper plate fit. Retrieve the appropriate lateral TTC plate based on the patient's anatomy. The plate should be positioned such that the proximal aspect is centered from anterior to posterior on the tibia, the central talar hole is centered on the body of the talus and the posterior calcaneal holes align just inferior to the superior surface of the calcaneus. If necessary, a saw can be used to scrape the bone surfaces smooth to fit the contour of the plate. Attach the lateral Subtalar Precision Guide Arm to the plate prior to provisional fixation, if desired (shown).



Secure the plate to the lateral aspect of the tibiotalar joint using a long Olive Wire in a circular tibial hole and a short Olive Wires in the talus and calcaneus, as shown. Confirm plate position using fluoroscopy.



NOTE: The small hole in the talar portion of the plate is directly in line with the center of the tibial portion of the plate. Talar position can be verified using this hole for guidance. Confirm trajectory of subtalar screw using fluoroscopy.

PERMANENT FIXATION – PLATE SCREWS



NOTE: The talar screw holes accept Ø3.5 mm or Ø4.2 mm non-locking and locking screws. The use of Ø4.2 mm screws is demonstrated in this technique. When using the Ø3.5 mm screws, use the appropriate instrumentation as described on page 4.



Retrieve the Ø4.2 mm Locking Drill Guide and thread into a talar body screw hole. Drill, using the Ø2.8 mm Drill.

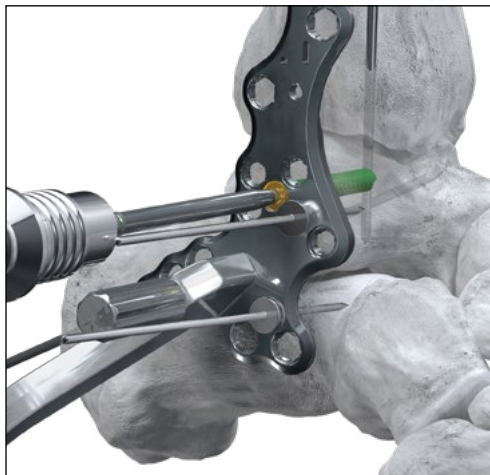

Remove the Ø4.2 mm Locking Drill Guide and measure screw length using the Depth Gauge (not shown). Insert the selected screw into the plate hole using the provided Driver and Handle. Do not fully tighten the screw until the second talar screw is secure, to prevent toggling of the plate.

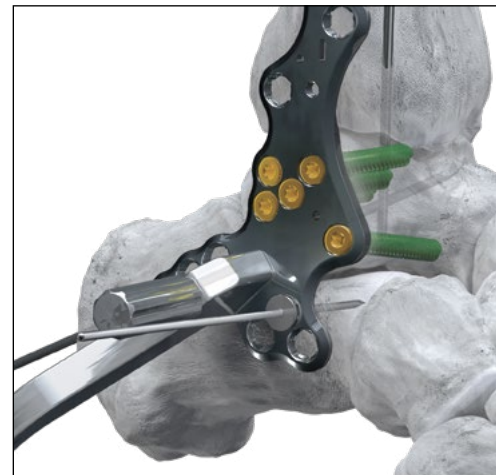

Remove the Olive Wire from the talus. Insert remaining locking or non-locking talar screws, per surgeon preference. It is recommended to drill using the Locking Drill Guide or the straight end of the Easy Guide, in order to achieve on-axis screw trajectories, which allows for placement of a crossing screw via the Precision Guide.



NOTE: Screw placement within the talus may be limited in cases of diseased or eroded tali.

PERMANENT FIXATION – PLATE SCREWS

NOTE: The tibial and calcaneal screw holes accept $\text{\O}4.5$ mm, $\text{\O}4.7$ mm, or $\text{\O}5.2$ mm screws. A laser etched dot on the plate indicates the plate holes that accept the $\text{\O}4.5$ mm, $\text{\O}4.7$ mm, and $\text{\O}5.2$ mm screws. The instructions provided below are for $\text{\O}4.5$ mm screws. When using the $\text{\O}4.7$ mm or $\text{\O}5.2$ mm screws, use the appropriate instrumentation as described on page 4.

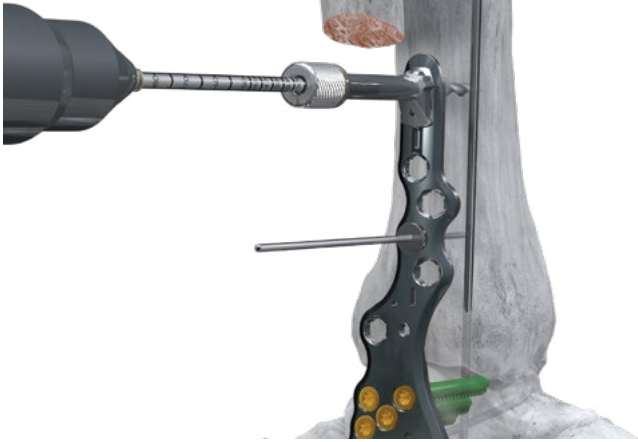

Retrieve the $\text{\O}4.5$ mm oblong Compression Slot Drill Guide and insert into the tibial compression slot with the arrow pointing toward the tibiotalar joint. Drill, using a $\text{\O}3.1$ mm Drill through the Compression Slot Drill Guide.



Remove the Compression Slot Drill Guide and measure screw length using the Depth Gauge. Insert a $\text{\O}4.5$ mm non-locking screw but do not fully seat.

PERMANENT FIXATION – TIBIOTALAR PRECISION GUIDED CROSSING SCREW

Retrieve the lateral TT Precision Guide Arm and Set Screw. The Precision Guide is attached to the plate as described on page 9. Place a K-wire Tube into the TT Precision Guide.

NOTE: K-wire Tubes for the Precision Guide are available in $\text{\O}1.6$ mm and $\text{\O}2.3$ mm, allowing for $\text{\O}5.5$ mm or $\text{\O}7.0$ mm Monster Screws to be used. Partially threaded and fully threaded screw options are available for each screw diameter, per surgeon preference. The use of a $\text{\O}7.0$ mm Monster Screw is demonstrated in this technique. When using the $\text{\O}5.5$ mm Monster Screw, use the appropriate instrumentation.

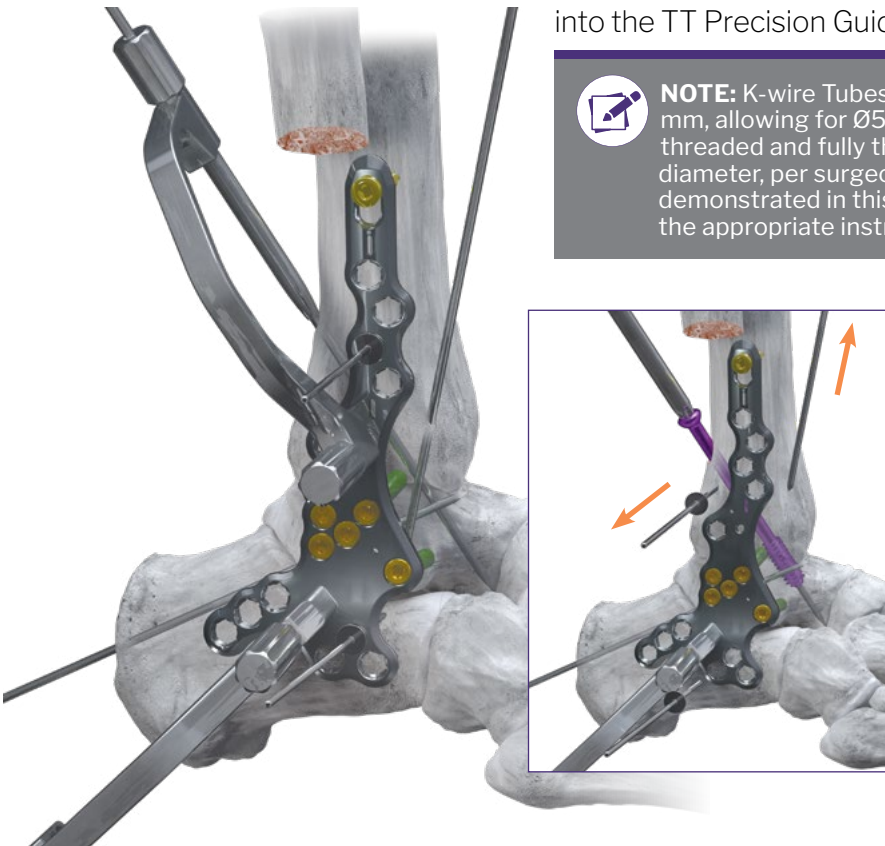

Insert a $\text{\O}7.0$ mm partially threaded headed Monster Screw across the TT joint using the technique described on pages 10 and 11. Remove the provisional fixation wire across the tibiotalar joint and the tibial and calcaneal Olive Wires prior to fully seating the Monster Screw. Confirm screw length and placement using fluoroscopy. Remove the $\text{\O}2.3$ mm K-wire serving as a guide wire.



Seat the $\text{\O}4.5$ mm non-locking screw in the tibia.

PERMANENT FIXATION – SUBTALAR PRECISION GUIDED CROSSING SCREW

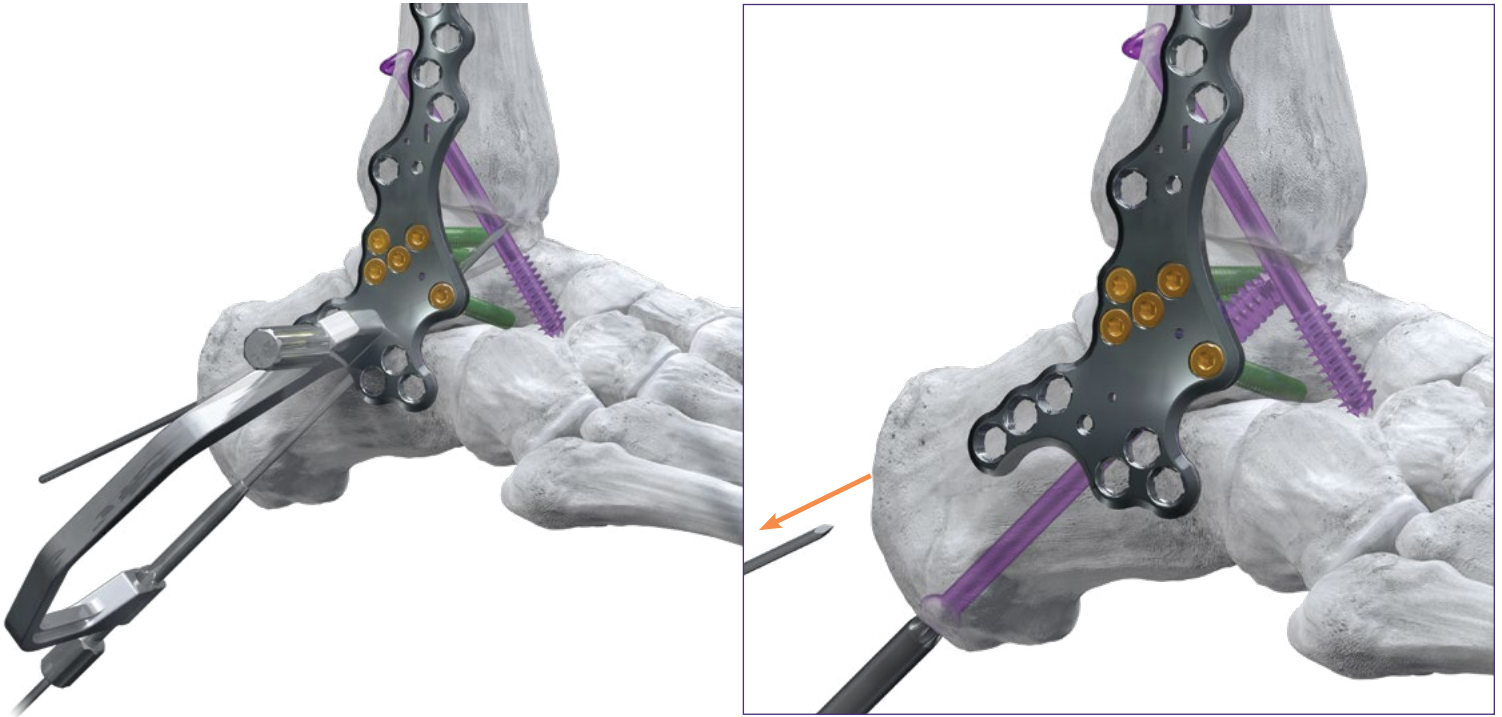

Retrieve the K-wire Tube and place into the lateral subtalar Precision Guide Arm. Insert a $\text{\O}2.3$ mm K-wire through the K-wire Tube across the subtalar joint.

Using the method outlined on pages 14 and 15, place a partially threaded $\text{\O}7.0$ mm Monster Screw across the subtalar joint. Remove provisional fixation across the subtalar joint prior to fully seating the Monster Screw.

PERMANENT FIXATION – TIBIA AND CALCANEAL PLATE SCREWS

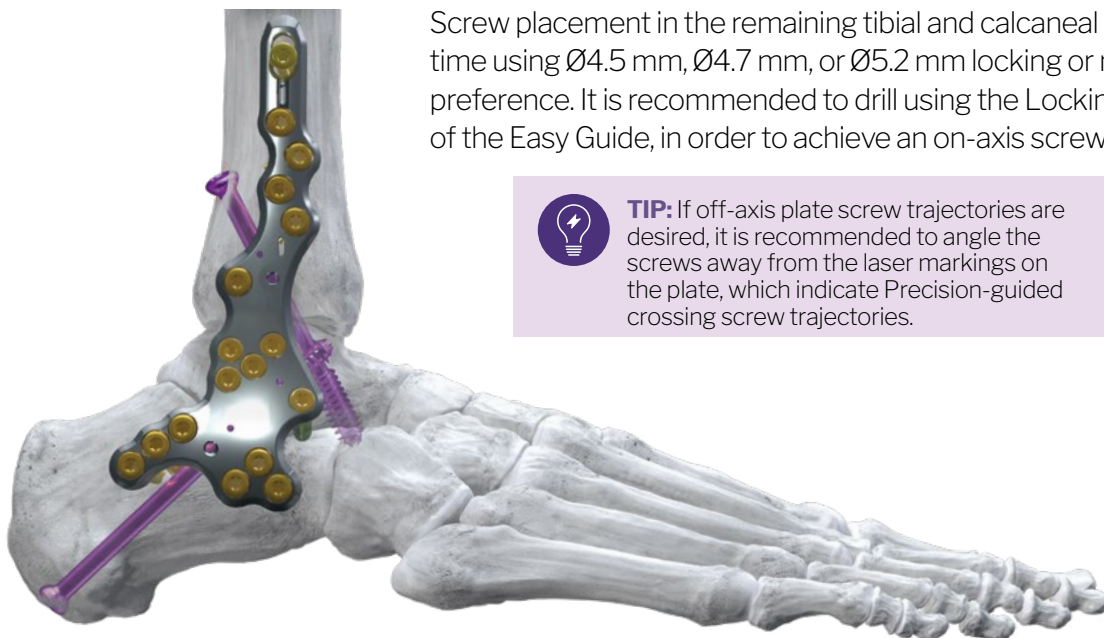

Screw placement in the remaining tibial and calcaneal plate holes is completed at this time using $\text{\O}4.5$ mm, $\text{\O}4.7$ mm, or $\text{\O}5.2$ mm locking or non-locking screws, per surgeon preference. It is recommended to drill using the Locking Drill Guide or the straight end of the Easy Guide, in order to achieve an on-axis screw trajectory.



TIP: If off-axis plate screw trajectories are desired, it is recommended to angle the screws away from the laser markings on the plate, which indicate Precision-guided crossing screw trajectories.

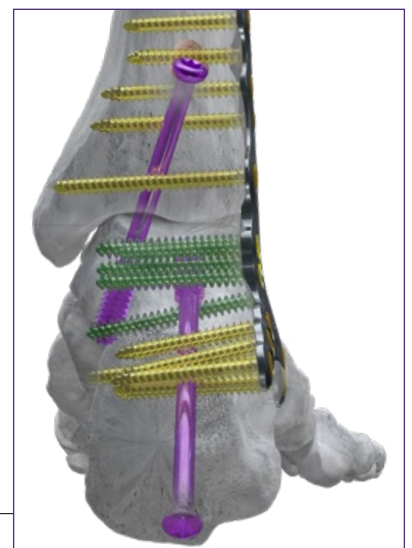

CLOSURE

Proceed to incision closure or concomitant procedures at this time.

INCISION/EXPOSURE

A lateral incision is made over the posterior half of the fibula, beginning approximately 10 cm proximal to the tip of the fibula and curving anterior distally toward the 4th metatarsal, just past the tip of the fibula.

Identify the sural nerve and retract it posteriorly. Continue dissection to the fibula. While retracting the peroneal tendons and sural nerve, a transverse fibular osteotomy is performed by beveling the saw from proximal lateral to distal medial to avoid a sharp bony prominence above the plate. Transect the syndesmotic and lateral ankle ligaments to free the fibula from adjacent soft tissues. Resect the fibula and retain for bone graft, if desired.

Elevate the anterior joint capsule and nearby periosteum to access the anterior tibiotalar joint articulation. Minimal dissection of the talar neck is recommended to avoid devascularization of this bone. Remove any anterior osteophytes that may interfere with joint reduction. Elevate the posterior soft tissues using a periosteal elevator to allow for retractors to be placed anterior to and posterior to the tibiotalar joint.



JOINT PREPARATION

Preparation of the tibiotalar joint can be performed as described on page 16, or per surgeon preference using the provided joint preparation instrumentation.

PERMANENT FIXATION

Steps for fixation of a lateral TT plate, screws and crossing screw can be performed as described previously for the lateral TTC plate.

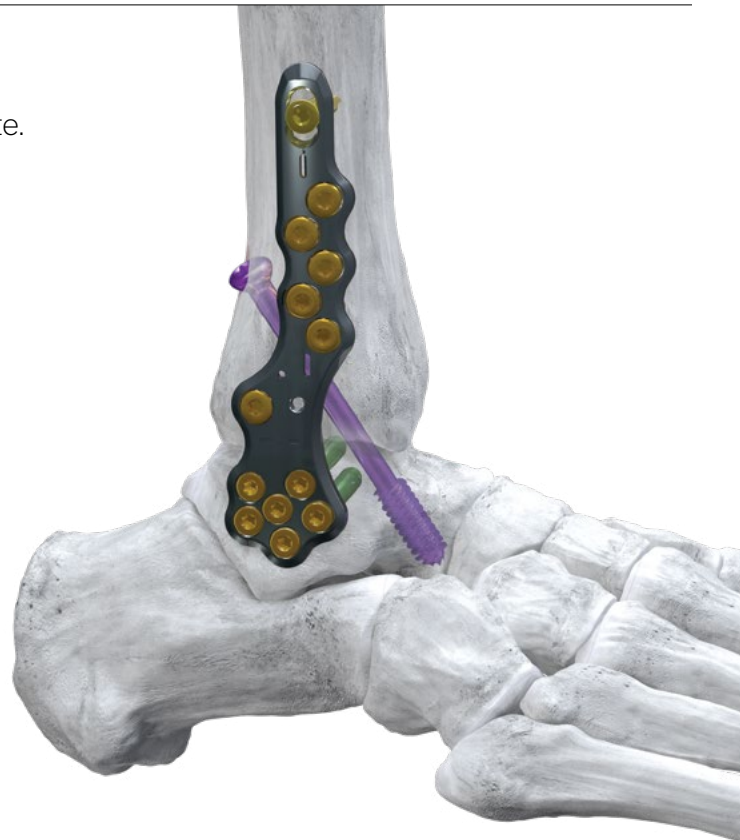

INCISION/EXPOSURE

TIBIOTALAR JOINT

A prone position should be utilized for this approach, with the foot and ankle extending off the end of the table to allow for a neutral foot position to be achieved. A longitudinal midline, full-thickness incision is made over the posterior tibiotalar joint centered over the Achilles tendon, beginning approximately 10 cm proximal to the ankle joint and terminating at the superior aspect of the calcaneus.

The Achilles tendon can be split along the midline, with care being taken to avoid undermining the subcutaneous tissue and paratenon. The deep fascia is incised and the flexor hallucis longus muscle is retracted medially. Upon exposing the posterior tibia and talus, a capsulotomy is made to expose the posterior tibiotalar joint. Remove any osteophytes on the tibia and talus to allow for exposure to the tibiotalar joint and facilitate entry of instrumentation for cartilage removal.



JOINT PREPARATION

Preparation of the tibiotalar joint can be performed using the provided joint preparation instrumentation. A Hindfoot Distractor is offered to allow for space and visualization during joint preparation, to be used with the Ø2.5 mm K-wires. The Hindfoot Distractor and K-wires are placed through the lateral aspect of the incision with appropriate soft tissue retraction, in a posterior to anterior direction. Following cartilage removal, it is advised to penetrate the subchondral plate with the Subchondral Drill, Burrs and/or Bone Fenestration Chisels to promote healing.

PROVISIONAL FIXATION

Align the ankle joint. The foot and ankle should be positioned such that the ankle is neutral with respect to dorsiflexion and plantarflexion. The foot should be in approximately 5-10° of external rotation and 5° of hindfoot valgus. With the foot and ankle held in this alignment use one or two Ø2.0 mm K-wires to temporarily fixate the tibiotalar joint, per surgeon preference. The provisional fixation wire should be placed in the posterolateral to anteromedial direction for the tibiotalar joint.



PLATE PLACEMENT



Resection of osteophytes or prominent bone may be necessary to ensure proper plate fit. Retrieve the appropriate posterior TT plate based on the patient's anatomy. To position the plate, center the talar portion of the plate on the talus, while ensuring that the proximal plate is midline or just lateral to midline.

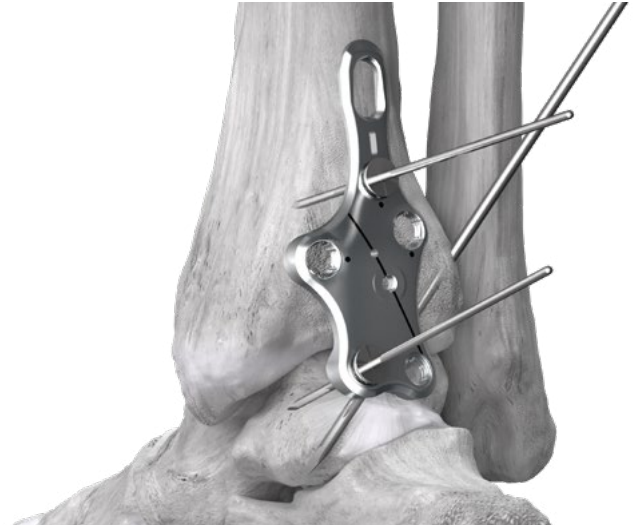

Secure the plate to the tibiotalar joint using a long Olive Wire in the most proximal circular hole on the tibia and a long Olive Wire in the medial (shown) or lateral talar screw hole, per surgeon preference. Confirm plate position using fluoroscopy.

PERMANENT FIXATION – PLATE SCREWS



NOTE: The talar screw holes accept Ø3.5 mm or Ø4.2 mm non-locking and locking screws. Ø4.2 mm screws are recommended for this area, except in the case of a small patient. The use of Ø4.2 mm screws is demonstrated in this technique. When using Ø3.5 mm screws, use the appropriate instrumentation as described on page 4.



Retrieve the Ø4.2 mm Locking Drill Guide and thread into the lateral talar body screw hole. Drill, using the Ø2.8 mm Drill.

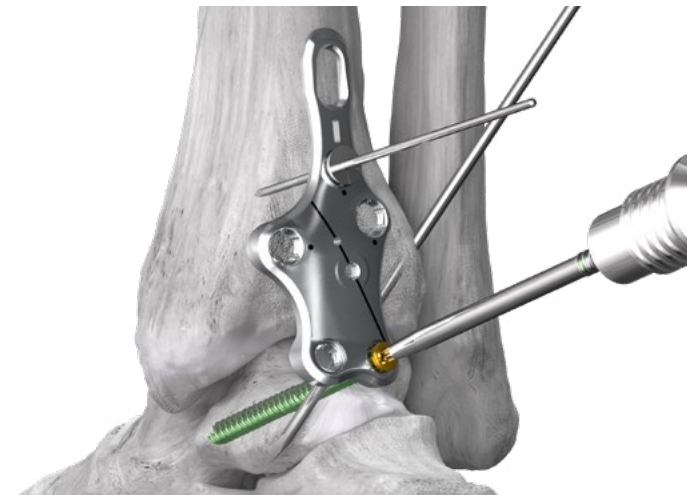

Remove the Ø4.2 mm Locking Drill Guide and measure screw length using the Depth Gauge. Confirm screw projection and length using the Depth Gauge under fluoroscopy (not shown). Insert the selected screw in the plate using the provided Driver and Handle. Do not fully tighten the talar screws until the tibial compression screw is placed and the Monster Screw is fully seated.



NOTE: The appropriate Locking Drill Guide is recommended for the talar screws and two distal tibia screws to achieve on-axis trajectory.

PERMANENT FIXATION – PLATE SCREWS

Remove the Olive Wire in the medial talar body. Insert a second Ø4.2 mm screw into the medial talar body hole using the same procedure previously described. Do not fully seat.

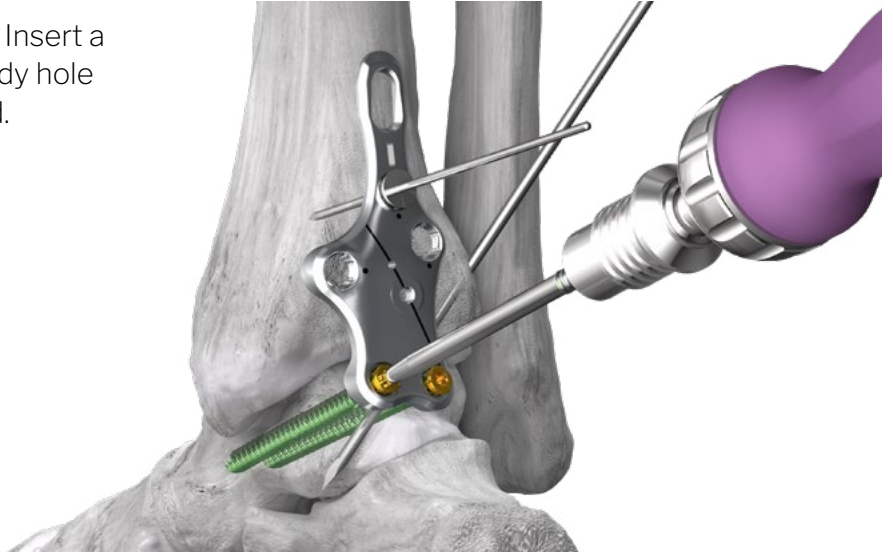

PERMANENT FIXATION – TIBIAL COMPRESSION SCREW



NOTE: The tibial screw holes accept Ø4.5 mm, Ø4.7 mm, or Ø5.2 mm locking or non-locking screws. A laser etched dot on the plate indicates the plate holes that accept Ø4.5 mm, Ø4.7 mm, and Ø5.2 mm screws. The technique demonstrates the use of the Ø4.5 mm screws. When using the Ø4.7 mm or Ø5.2 mm screws, use the appropriate instrumentation as described on page 4.

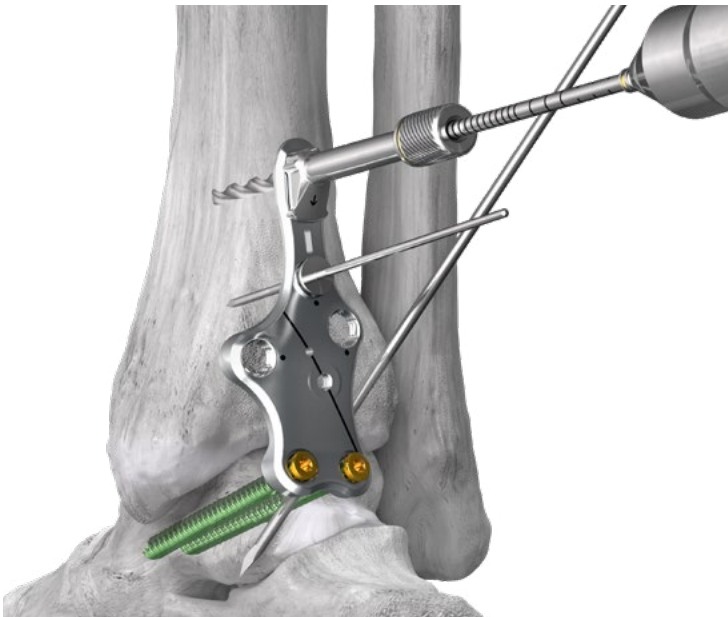

Retrieve the Ø4.5 mm oblong Compression Slot Drill Guide and insert into the tibial compression slot with the arrow pointing towards the tibiotalar joint. Drill, using a Ø3.1 mm Drill through the Compression Slot Drill Guide.

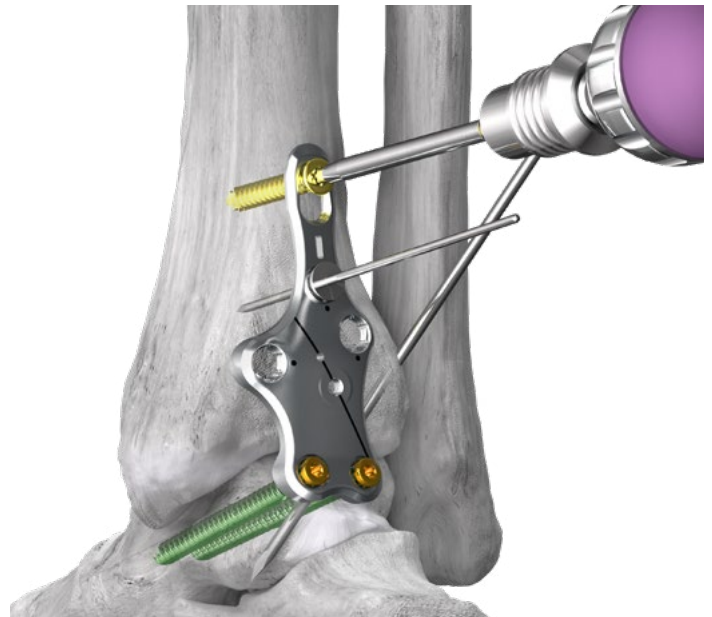

Remove the Compression Slot Drill Guide and measure screw length using the Depth Gauge. Insert a Ø4.5 mm non-locking screw. Do not fully tighten the screw until the tibiotalar crossing screw has been inserted and the talar body screws have been fully seated. This allows for travel of the compression screw distally in the slot during final tightening of the crossing screw.

PERMANENT FIXATION – PRECISION GUIDED CROSSING SCREW

Assemble and attach the posterior Precision Guide to the posterior TT plate as described on page 9.



NOTE: K-wire Tubes for the Precision Guide are available in Ø1.6 mm and Ø2.3 mm, allowing for Ø5.5 mm or Ø7.0 mm Monster Screws to be used. Partially threaded and fully threaded screw options are available for each screw diameter, per surgeon preference. The use of a Ø7.0 mm Monster Screw is demonstrated in this technique. When using the Ø5.5 mm Monster Screw, use the appropriate instrumentation.

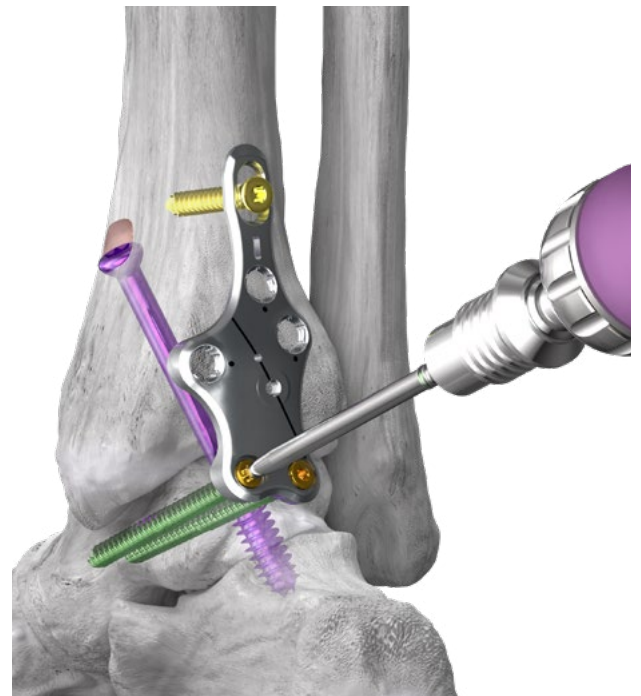
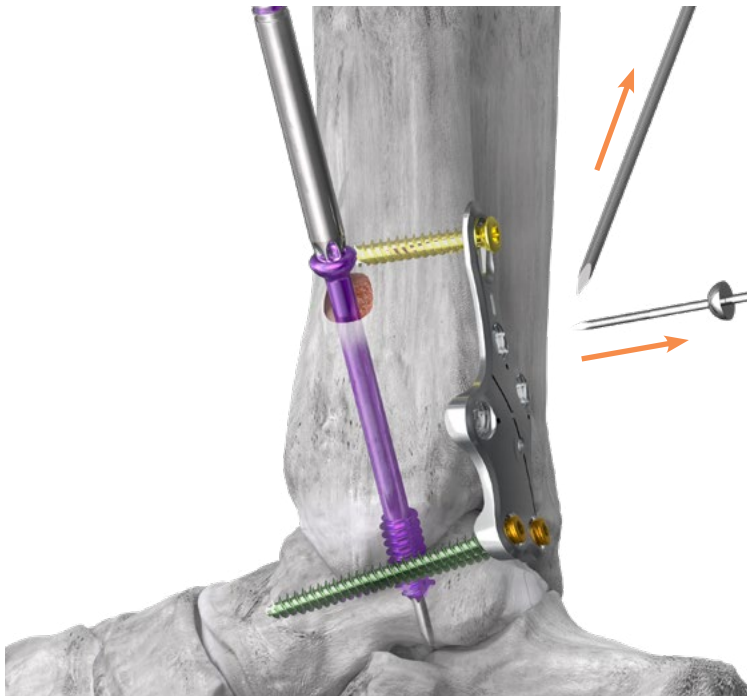
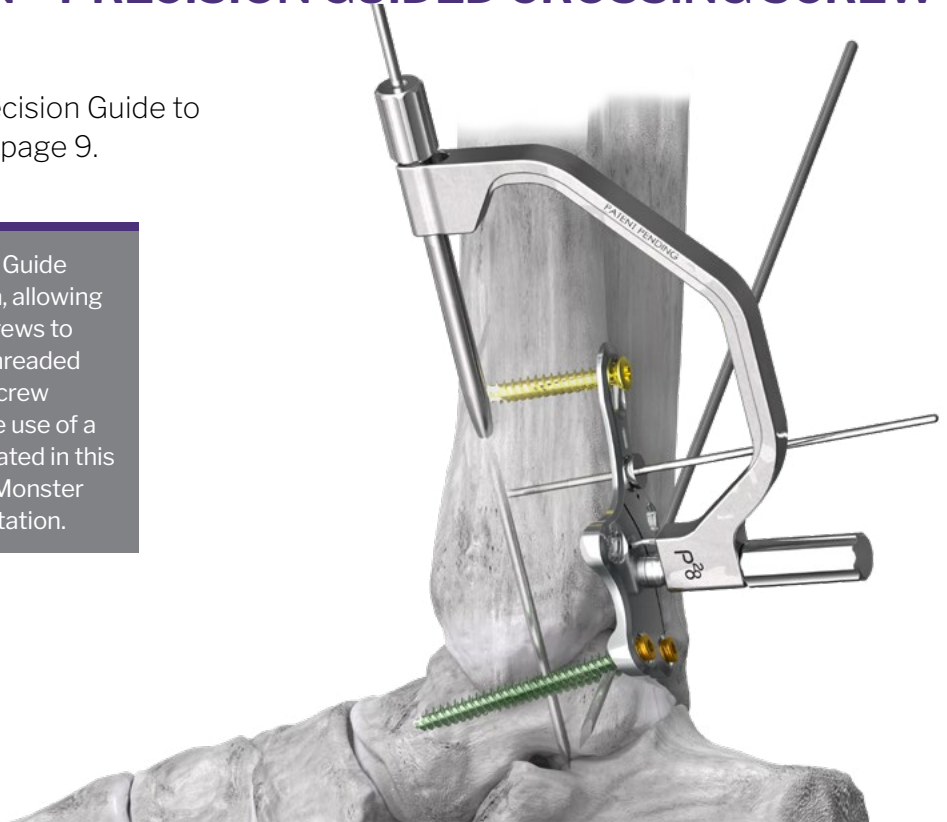

Insert the tibiotalar crossing screw as described on pages 10 and 11. Prior to seating the Monster Screw head against bone, remove the Olive Wire from the tibial screw hole and the provisional fixation across the tibiotalar joint. Fully seat the Monster Screw, then confirm screw length and placement using fluoroscopy. Remove the Ø2.3 mm K-wire.

Fully seat the talar body screws.

PERMANENT FIXATION – PLATE SCREWS

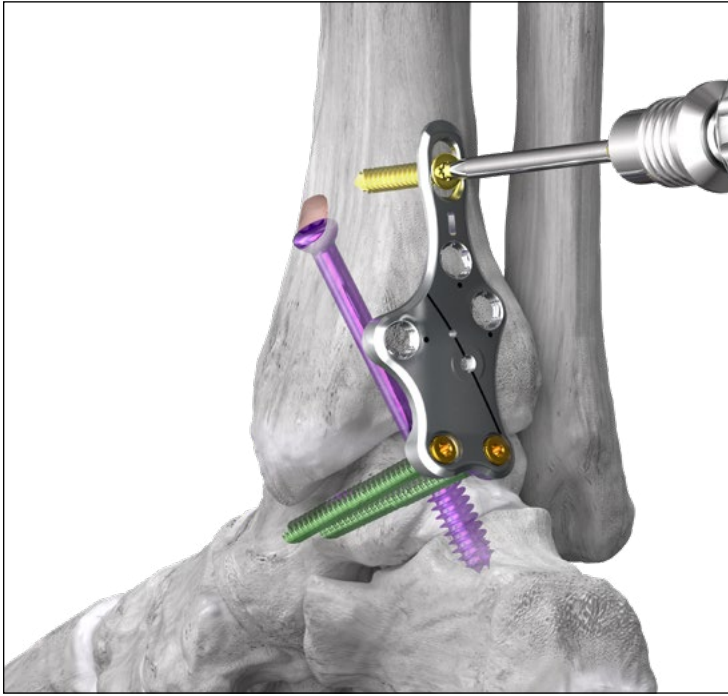

Fully seat the non-locking screw in the tibial compression slot.

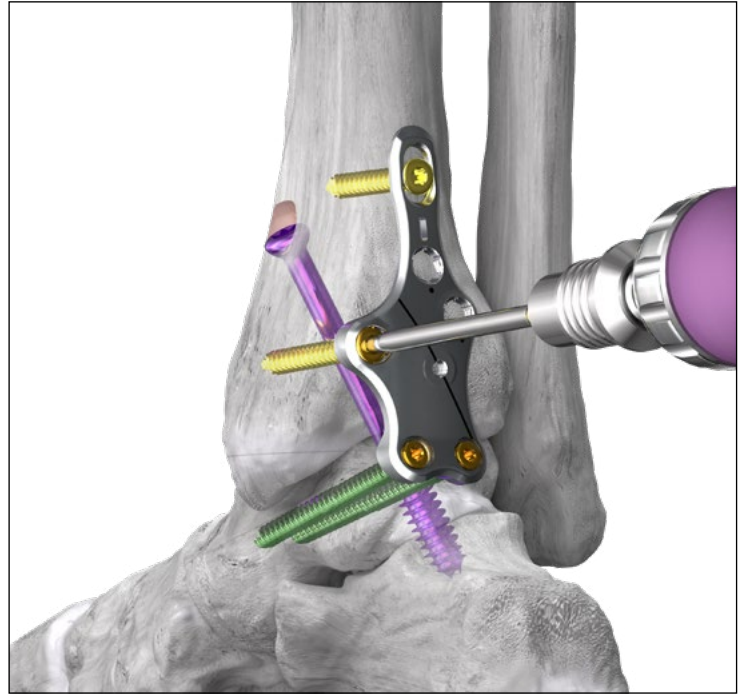

Insert the remaining tibial screws using the technique previously described for Ø4.5 mm screws.

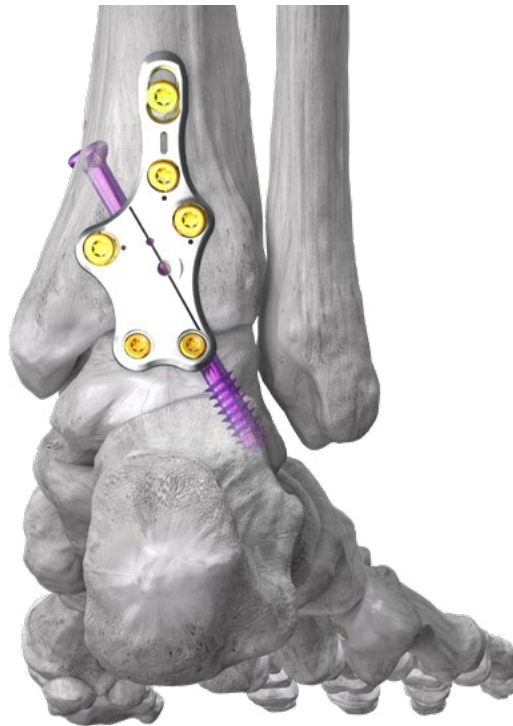

Confirm screw position and placement using fluoroscopy.

CLOSURE

Proceed to incision closure or concomitant procedures at this time.

INCISION/EXPOSURE

The incision for the posterior TTC plate is made as described on page 21 for the posterior TT arthrodesis surgical technique; however, a longer incision is made to allow for access to the subtalar joint, in addition to the tibiotalar joint.

A capsulotomy is made to expose the posterior tibiotalar and subtalar joints. Remove any osteophytes on the tibia, talus, and calcaneus to allow for exposure to the tibiotalar and subtalar joints and facilitate entry of instrumentation for cartilage removal. All osteophytes must be removed from the posterior tibiotalar and subtalar joints to facilitate application of the plate.



JOINT PREPARATION

Preparation of the tibiotalar joint can be performed using the provided joint preparation instrumentation. A Hindfoot Distractor is offered to allow for space and visualization during joint preparation, to be used with the Ø2.5 mm K-wires. It is advised to penetrate the subchondral plate with the Subchondral Drill, Burrs and/or Chisels to promote healing.

Remove cartilage from the posterior, middle and anterior facets of the subtalar joint. Perform subchondral plate penetration to these joints to promote healing.

PROVISIONAL FIXATION

Align the ankle joint. The foot and ankle should be positioned such that the ankle is neutral with respect to dorsiflexion and plantarflexion. The foot should be in approximately 5-10° of external rotation and 5° of hindfoot valgus. With the foot and ankle held in this alignment, use multiple Ø2.0 mm K-wires to temporarily fix the tibiotalar and subtalar joints as shown. Provisional fixation wires should be placed in the posterolateral to anteromedial direction for the tibiotalar joint and posterior to anterior direction for the subtalar joint, biased slightly medially.



PLATE POSITIONING AND PROVISIONAL FIXATION

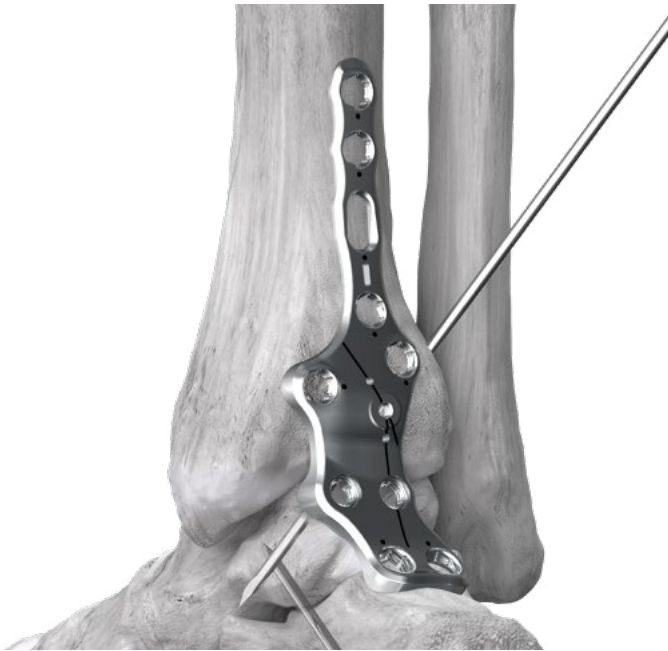

Resection of osteophytes or prominent bone may be necessary to ensure proper plate fit. Retrieve the appropriate posterior TTC plate based on the patient's anatomy. To position the plate, center the talar portion of the plate on the talus, while ensuring that the proximal plate is midline or just lateral to midline and that the distal plate is centered over the superior calcaneus.

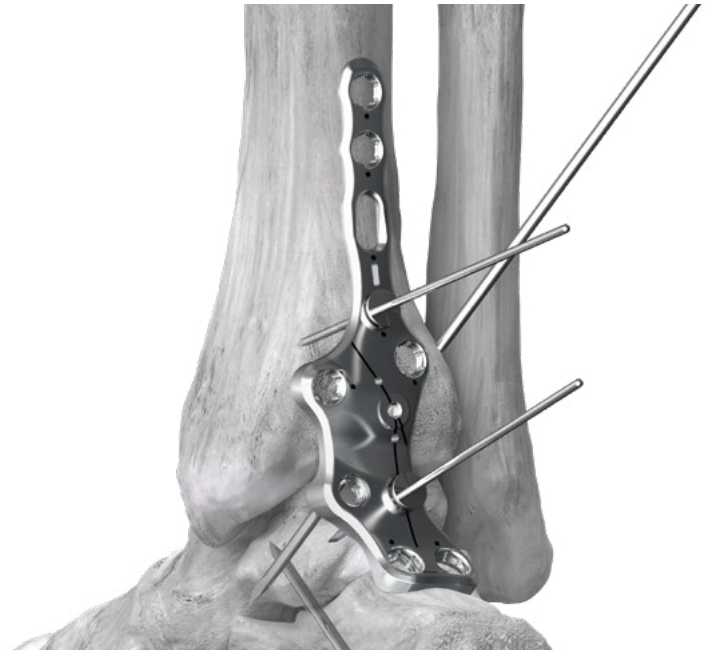

Secure the plate to the posterior aspect of the tibiotalar joint using a long Olive Wire in the circular tibial hole inferior to the compression slot and a long Olive Wire in the medial or lateral (shown) talar hole, per surgeon preference. Confirm plate position using fluoroscopy.

PERMANENT FIXATION – PLATE SCREWS

 **NOTE:** The talar screw holes accept Ø3.5 mm or Ø4.2 mm non-locking and locking screws. The use of Ø4.2 mm screws is demonstrated in this technique. When using the Ø3.5 mm screws, use the appropriate instrumentation as describe on page 4.

Retrieve the Ø4.2 mm Locking Drill Guide and thread into the medial talar body screw hole. Drill, using the Ø2.8 mm Drill.

 **NOTE:** The appropriate Locking Drill Guide is recommended for the talar screws, calcaneal screws and two distal tibia screws to achieve on-axis trajectory and avoid interference with the Precision Guided crossing screws.

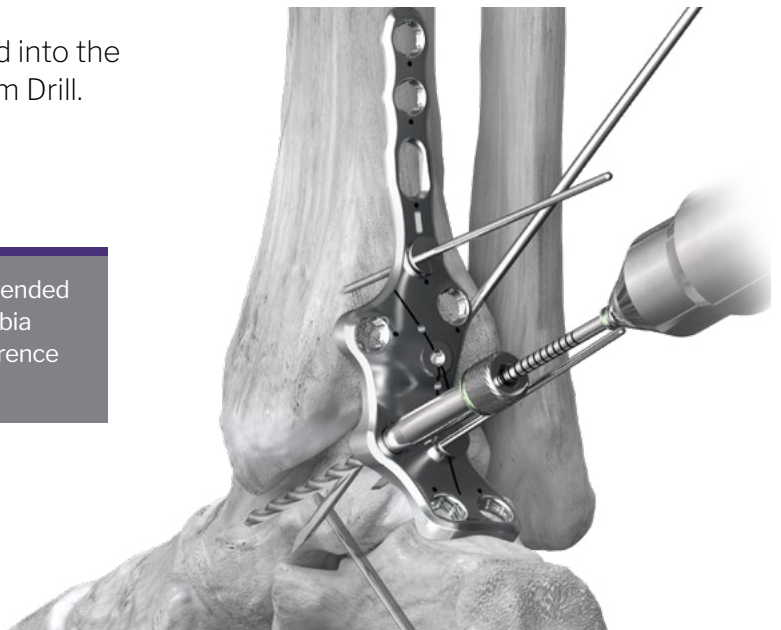

PERMANENT FIXATION – PLATE SCREWS

Remove the Ø4.2 mm Locking Drill Guide and measure screw length using the Depth Gauge (not shown). Insert the selected screw into the plate hole using the Driver and Handle. Do not fully tighten the talar screws until the Monster Screw is fully seated, to prevent toggling of the plate.

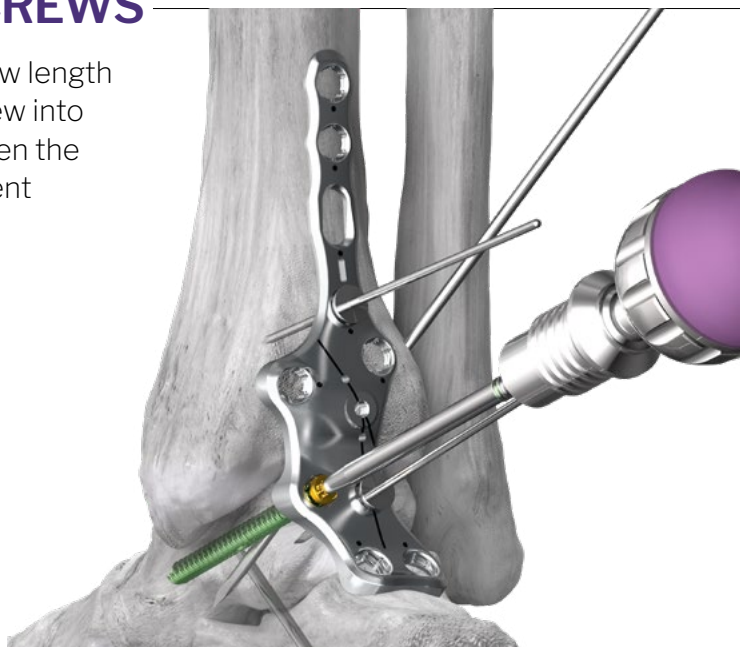
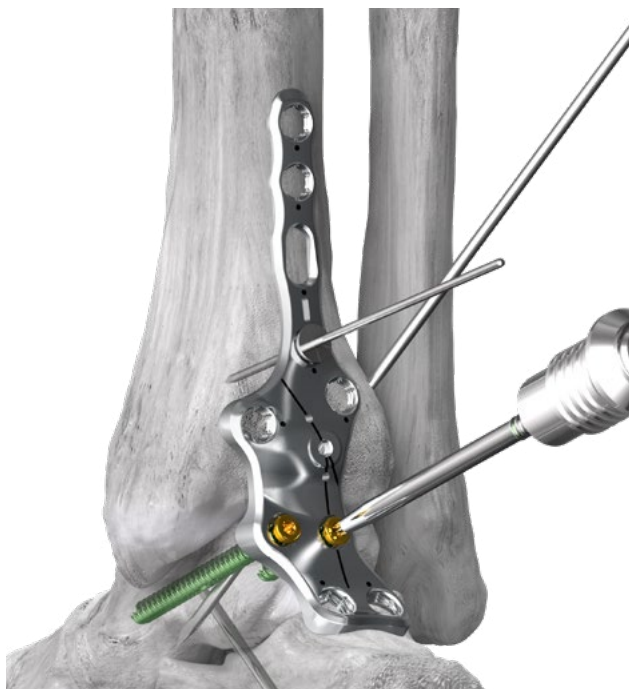

Remove the adjacent Olive Wire from the lateral talar body. Insert the remaining locking or non-locking talar screw, per surgeon preference.



NOTE: The lateral talar body screw must be 24 mm or shorter in length to avoid the projected trajectory of the subtalar crossing screw.



NOTE: The tibial and calcaneal screw holes accept Ø4.5, Ø4.7 mm, or Ø5.2 mm screws. A laser etched dot on the plate indicates the plate holes that accept the Ø4.5 mm, Ø4.7 mm, and Ø5.2 mm screws. The instructions provided below are the Ø4.5 screws. When using the Ø4.7 mm or Ø5.2 mm screws, use the appropriate instrumentation as described on page 4.

Retrieve the Ø4.5 mm oblong Compression Slot Drill Guide and insert into the tibial compression slot with the arrow pointing toward the tibiotalar joint. Drill, using a Ø3.1 mm Drill through the Compression Slot Drill Guide.

Remove the Compression Slot Drill Guide and measure screw length using the Depth Gauge. Insert a Ø4.5 mm non-locking screw, but do not fully seat the compression screw until the tibiotalar crossing screw has been inserted and the talar body screws are fully seated. This allows for travel of the compression screw distally in the slot during final tightening of the crossing screw.

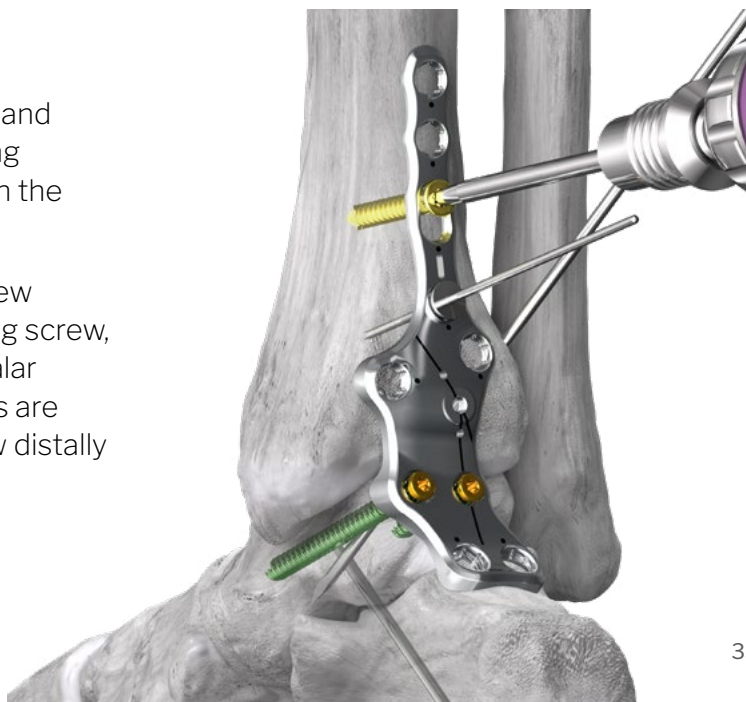

PERMANENT FIXATION – TIBIOTALAR PRECISION GUIDED CROSSING SCREW

Retrieve the posterior TT Precision Guide Arm and Set Screw. The Precision Guide is attached to the plate as described on page 9.

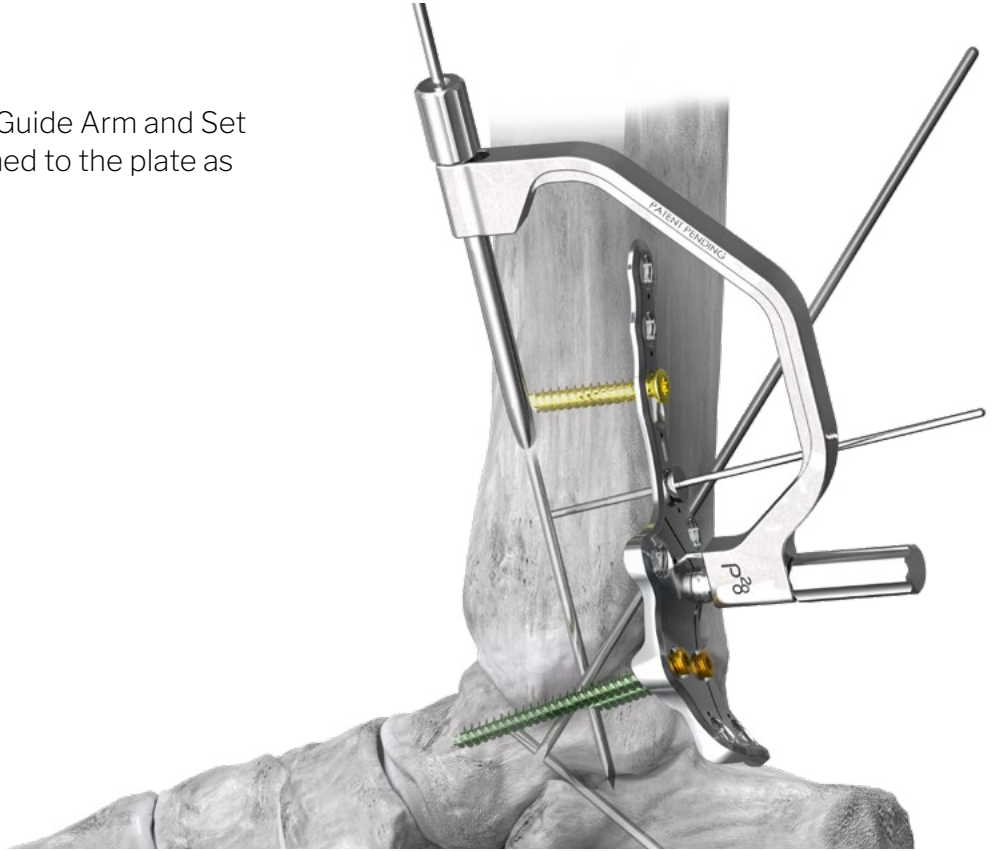

NOTE: K-wire Tubes for the Precision Guide are available in Ø1.6 mm and Ø2.3 mm, allowing for Ø5.5 mm or Ø7.0 mm Monster Screws to be used. Partially threaded and fully threaded screw options are available for each screw diameter, per surgeon preference. The use of a Ø7.0 mm Monster Screw is demonstrated in this technique. When using the Ø5.5 mm Monster Screw, use the appropriate instrumentation.

Insert a Ø7.0 mm partially threaded headed Monster Screw using the technique described on pages 10 and 11. Prior to seating the Monster Screw head against bone, remove the Olive Wire from the tibial screw hole and the provisional fixation across the tibiotalar joint. Fully seat the Monster Screw, then confirm screw length and placement using fluoroscopy. Remove the Ø2.3 mm K-wire serving as a guide wire.

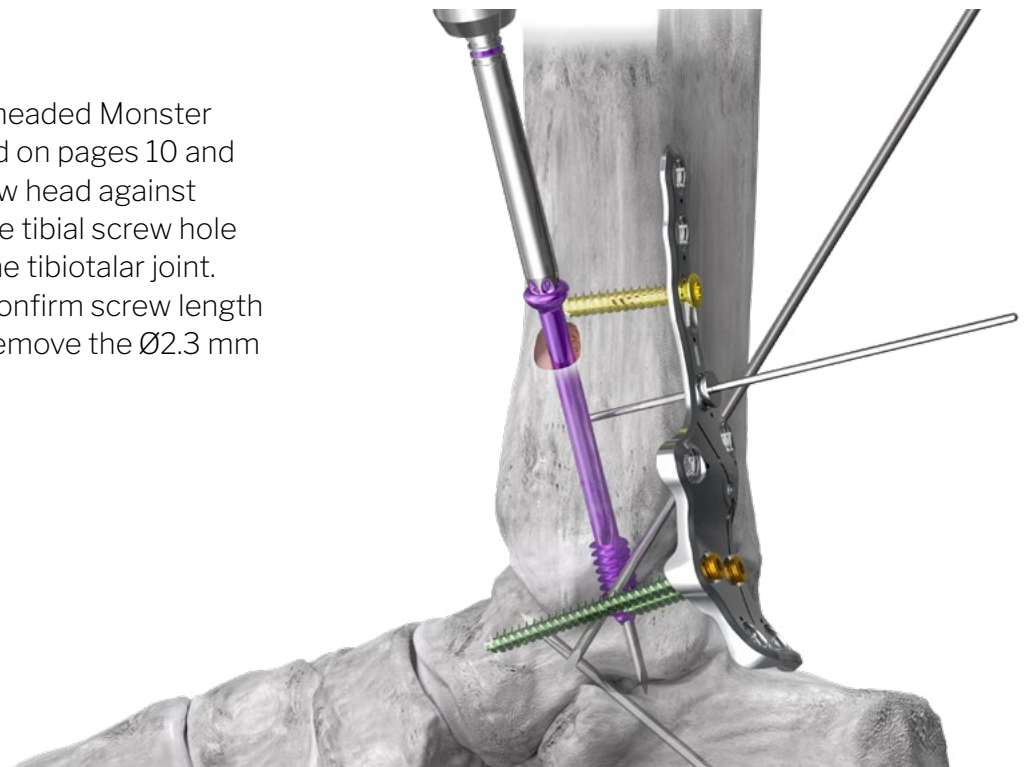

PERMANENT FIXATION – TIBIOTALAR PRECISION GUIDED CROSSING SCREW

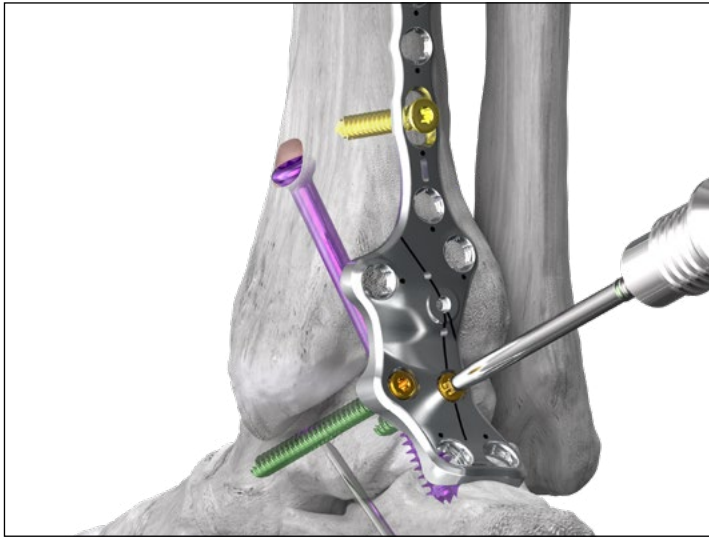

Fully seat the talar body screws.

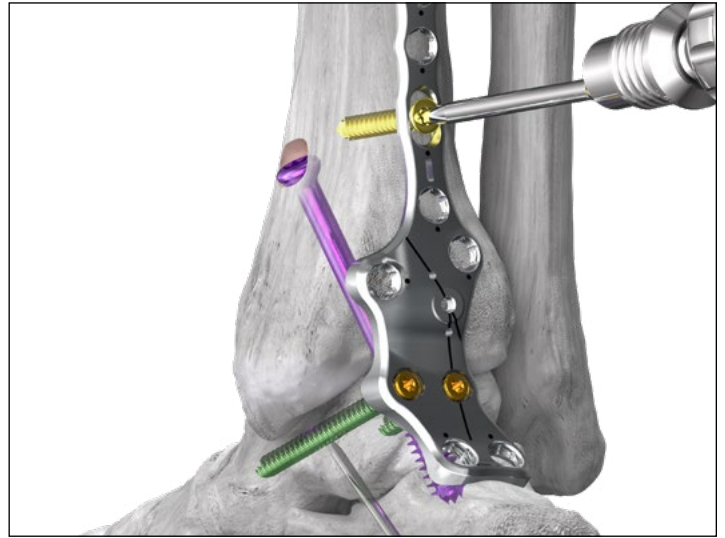

Fully seat the tibial compression screw.

PERMANENT FIXATION – SUBTALAR PRECISION GUIDED CROSSING SCREW

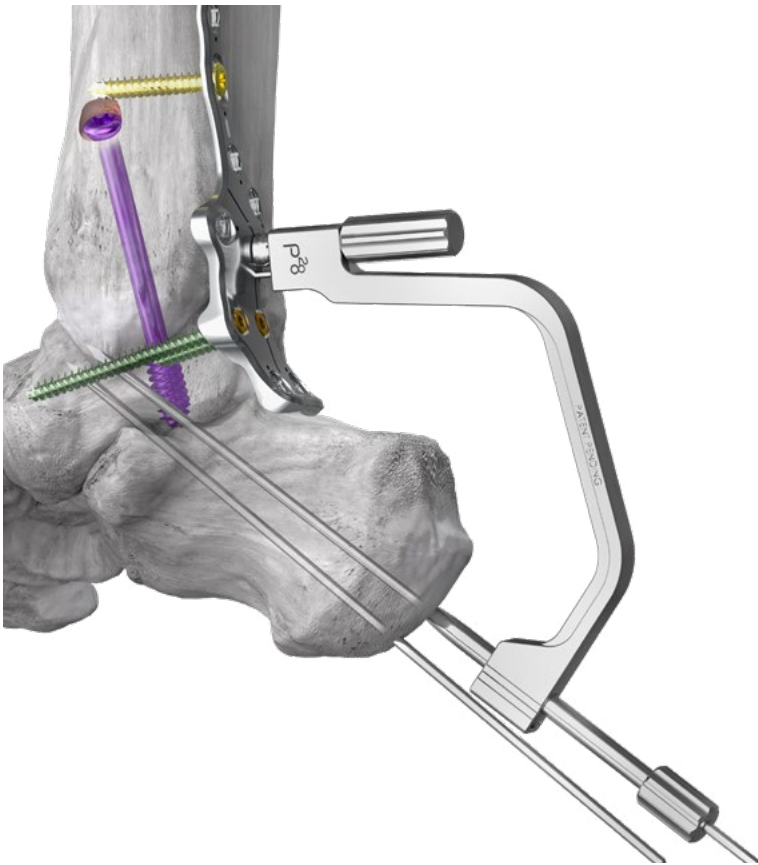

Retrieve the posterior Subtalar Precision Guide Arm and Set Screw. The Precision Guide is attached to the plate as described on page 9. Insert a Ø2.3 mm K-wire through the K-wire Tube across the subtalar joint.

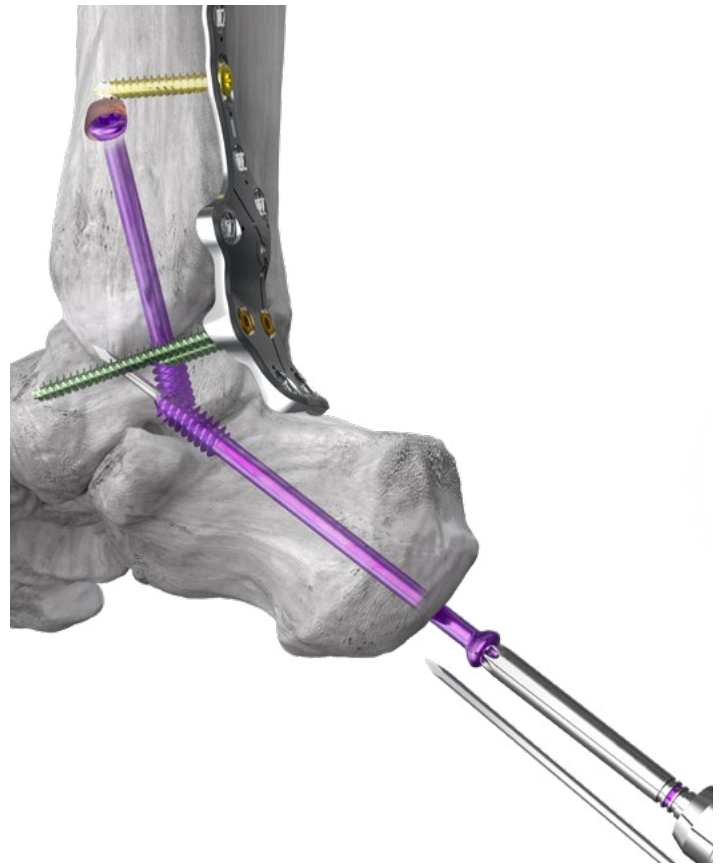

Using the method outlined on pages 10 and 11, insert a partially threaded Ø7.0 mm Monster Screw across the subtalar joint. Remove the provisional fixation wire across the subtalar joint prior to fully seating the Monster Screw.

PERMANENT FIXATION – TIBIA AND CALCANEAL PLATE SCREWS

Screw placement in the remaining tibial and calcaneal plate holes is completed at this time using $\varnothing 4.5$ mm, $\varnothing 4.7$ mm, or $\varnothing 5.2$ mm locking or non-locking screws, per surgeon preference.



TIP: If off-axis plate screw trajectories are desired, it is recommended to angle the screws away from the laser markings on the plate, which indicate Precision-guided crossing screw trajectories.

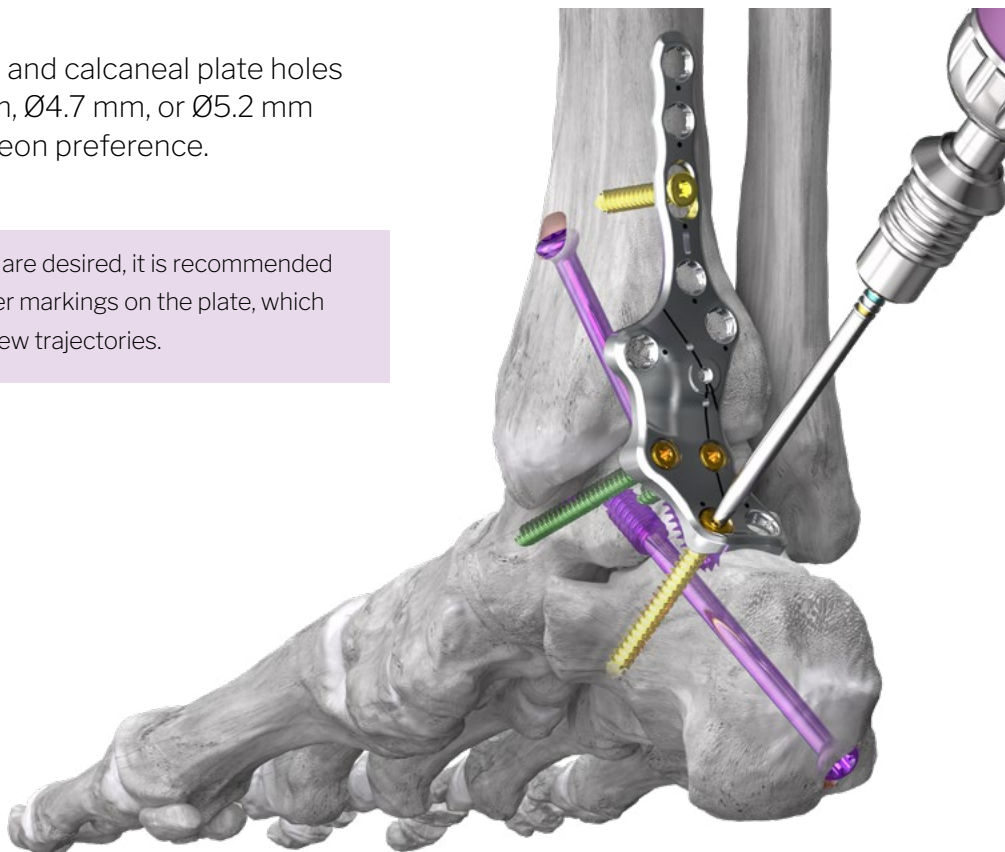

Confirm screw position and placement using fluoroscopy.

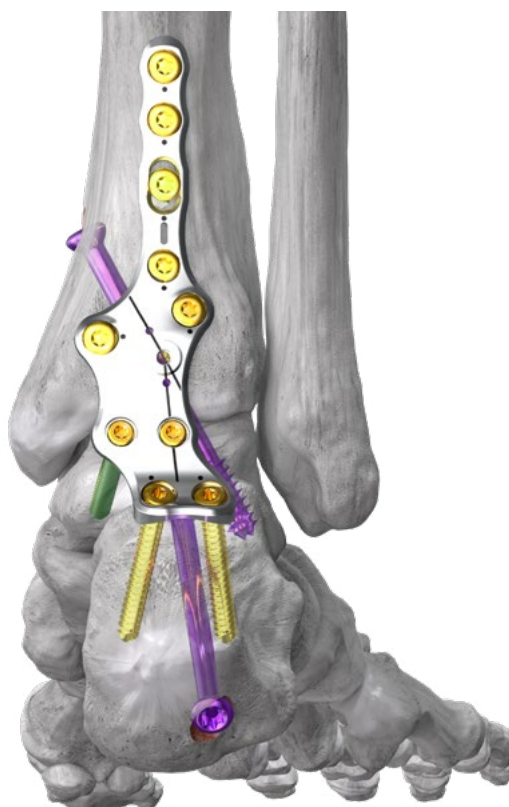

CLOSURE

Proceed to incision closure or concomitant procedures at this time.

Silverback Anterior Mini-Open Plate Caddy

Anterior Mini Open TT plates with corresponding Precision Guide Arms and Precision Guide Arms Base are located within the Mini-Open Anterior Plate Caddy.



Silverback Anterior Plate Caddy

Anterior TT, and TTC plates with corresponding Precision Guide Arms and Precision Guide Arms Base are located within the Anterior Plate Caddy.

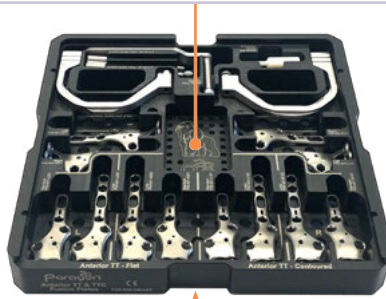

Silverback Lateral Plate Caddy

Lateral TT and TTC plates and corresponding Precision Guides are located within the Lateral Plate Caddy.



Silverback K-wire and Olive Wire Caddy

Smooth and threaded K-wires and Olive Wires and a ruler are located within the K-wire and Olive Wire Caddy.



Silverback Posterior Plate Caddy

Posterior TT and TTC plates and corresponding Precision Guides are located within the Posterior Plate Caddy.



Silverback Instrument Tray

All drill guides, drills, overdrills, taps, drivers, forceps and a depth gauge are located within the Silverback

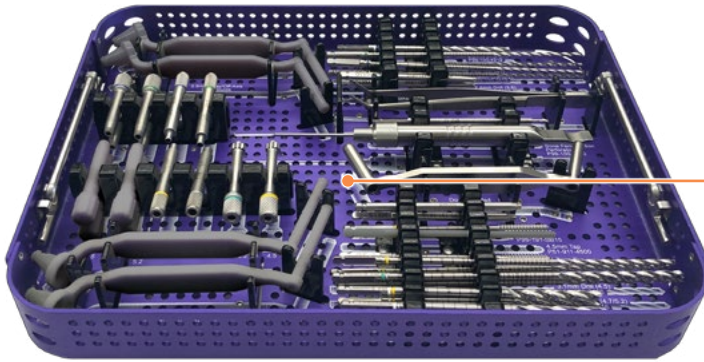

Silverback Screw Caddy

The Silverback screw length options for locking and non-locking screws:

3.5 mm	2 mm increments, 14-30 mm	
4.2 mm	2 mm increments, 14-50 mm	
4.2 mm	5 mm increments, 55-60 mm	
4.5 mm	2 mm increments, 14-50 mm	
4.5 mm	5 mm increments, 55-60 mm	
5.2 mm	2 mm increments, 14-50 mm	
5.2 mm	5 mm increments, 55-60 mm	

The Silverback compact screw length options are as follows:

4.7 mm	2 mm increments, 20-40 mm	
--------	---------------------------	--

Silverback Case Base

Handles, plate bending instrumentation and joint preparation instrumentation including curettes, osteotomes, Chisels and a cartilage removal tool are located at the bottom of the Silverback Instrument Case.

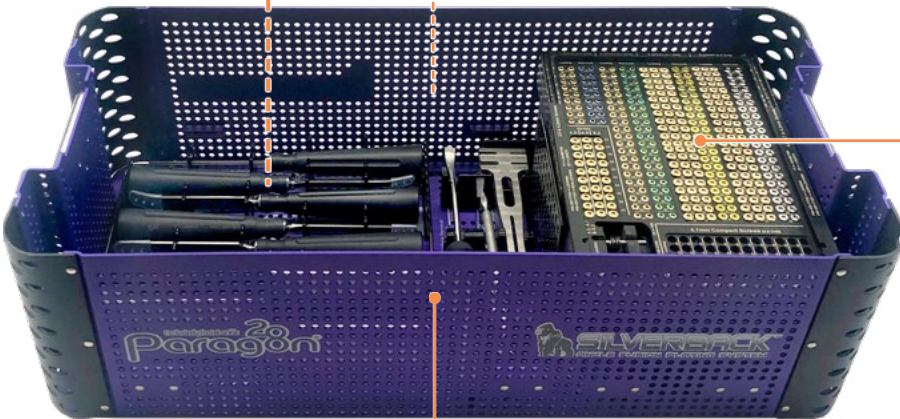

Refer to www.paragon28.com/ifus for the complete and most current instructions for use document.

INDICATIONS FOR USE: BABY GORILLA[®]/GORILLA[®] PLATING SYSTEM

The bone plates and bone screws of the Baby Gorilla[®]/Gorilla[®] Plating System are indicated for use in stabilization and fixation of fractures or osteotomies; intra and extra articular fractures, joint depression, and multi-fragmentary fractures; revision procedures, joint fusion and reconstruction of small bones of the toes, feet and ankles including the distal tibia, distal fibula, talus, and calcaneus. The system can be used in both adult and pediatric patients.

In addition, the non-locking, titanium alloy (Ti6Al4V ELI) screws and washers are indicated for use in bone reconstruction, osteotomy, arthrodesis, joint fusion, fracture repair and fracture fixation of the foot and ankle, including the tibia, fibula, tarsus, metatarsals, and phalanges, appropriate for the size of the device.

CONTRAINDICATIONS

Use of the Baby Gorilla[®]/Gorilla[®] Plating System is contraindicated in cases of inflammation, cases of active or suspected sepsis / infection and osteomyelitis; or in patients with certain metabolic diseases.

All applications that are not defined by the indications are contraindicated. In addition, surgical success can be adversely affected by:

- Acute or chronic infections, local or systemic
- Vascular, muscular or neurological pathologies that compromise the concerned extremity
- All concomitant pathologies that could affect the function of the implant
- Osteopathies with reduced bone substance that could affect the function of the implant
- Any mental or neuromuscular disorder that could result in an unacceptable risk of failure at the time of fixation or complications in post-operative treatment
- Known or suspected sensitivity to metal
- Corpulence; an overweight or corpulent patient can strain the implant to such a degree that stabilization or implant failure can occur
- Whenever the use of the implant comes into conflict with the anatomical structures of physiological status

Other medical or surgical pre-conditions that could compromise the potentially beneficial procedure, such as:

- The presence of tumors
- Congenital abnormalities
- Immunosuppressive pathologies
- Increased sedimentation rates that cannot be explained by other pathologies
- Increased leukocyte (WBC) count
- Pronounced left shift in the differential leukocyte count

POTENTIAL COMPLICATIONS AND ADVERSE REACTIONS

In any surgical procedure, the potential for complications and adverse reactions exist. The risks and complications with these implants include:

- Loosening, deformation or fracture of the implant
- Acute post-operative wound infections and late infections with possible sepsis
- Migration, subluxation of the implant with resulting reduction in range of movement
- Fractures resulting from unilateral joint loading
- Thrombosis and embolism
- Wound hematoma and delayed wound healing
- Temporary and protracted functional neurological perturbation
- Tissue reactions as the result of allergy or foreign body reaction to dislodged particles
- Corrosion with localized tissue reaction and pain
- Pain, a feeling of malaise or abnormal sensations due to the implant used
- Bone loss due to stress shielding

All possible complications listed here are not typical of Paragon 28[®], Inc. products but are in principle observed with any implant. Promptly inform Paragon 28[®], Inc. as soon as complications occur in connection with the implants or surgical instruments used. In the event of premature failure of an implant in which a causal relationship with its geometry, surface quality or mechanical stability is suspected, please provide Paragon 28[®], Inc. with the explant(s) in a cleaned, disinfected and sterile condition. Paragon 28[®], Inc. cannot accept any other returns of used implants. The surgeon is held liable for complications associated with inadequate asepsis, inadequate preparation of the osseous implant bed in the case of implants, incorrect indication or surgical technique or incorrect patient information and consequent incorrect patient behavior.

WARNINGS AND PRECAUTIONS

- Re-operation to remove or replace implants may be required at any time due to medical reasons or device failure. If corrective action is not taken, complications may occur.
- Use of an undersized plate or screw in areas of high functional stresses may lead to implant fracture and failure.
- Plates and screws, wires, or other appliances of dissimilar metals should not be used together in or near the implant site.
- The implants and guide wires are intended for single use only.
- Instruments, guide wires and screws are to be treated as sharps.
- Patient risk as a result of the Baby Gorilla[®]/Gorilla[®] Plating System in the MR environment has been minimized.
- **Do not use other manufacturer's instruments or implants in conjunction with the Baby Gorilla[®]/Gorilla[®] Plating System.**
- **Do not implant the instruments.**

MR SAFETY INFORMATION

The Baby Gorilla[®]/Gorilla[®] Plating System has been evaluated for safety and compatibility in the MR environment. It has not been tested for heating, migration or image artifact in the MR environment. The safety of the Baby Gorilla[®]/Gorilla[®] Plating System in the MR environment is unknown. Scanning a patient who has this device may result in patient injury.

Refer to www.paragon28.com/ifus for the complete and most current instructions for use document.

INDICATIONS FOR USE: MONSTER® SCREW SYSTEM

The Monster® Screw System is indicated for use in bone reconstruction, osteotomy, arthrodesis, joint fusion, ligament fixation, fracture repair and fracture fixation of the foot and ankle, including the tibia, fibula, tarsus, metatarsals, and phalanges and the joints and ligaments coupling said bones, appropriate for the size of the device.

CONTRAINDICATIONS

Use of the Monster® Screw System is contraindicated in cases of inflammation, cases of active or suspected sepsis / infection and osteomyelitis; or in patients with certain metabolic diseases.

All applications that are not defined by the indications are contraindicated. In addition, surgical success can be adversely affected by:

- Acute or chronic infections, local or systemic
- Vascular, muscular or neurological pathologies that compromise the concerned extremity
- All concomitant pathologies that could affect the function of the implant
- Osteopathies with reduced bone substance that could affect the function of the implant
- Any mental or neuromuscular disorder that could result in an unacceptable risk of failure at the time of fixation or complications in post-operative treatment
- Known or suspected sensitivity to metal
- Corpulence; an overweight or corpulent patient can strain the implant to such a degree that stabilization or implant failure can occur
- Whenever the use of the implant comes into conflict with the anatomical structures of physiological status

Other medical or surgical pre-conditions that could compromise the potentially beneficial procedure, such as:

- The presence of tumors
- Congenital abnormalities
- Immunosuppressive pathologies
- Increased sedimentation rates that cannot be explained by other pathologies
- Increased leukocyte (WBC) count
- Pronounced left shift in the differential leukocyte count

POTENTIAL COMPLICATIONS AND ADVERSE REACTIONS

In any surgical procedure, the potential for complications and adverse reactions exist. The risks and complications with these implants include:

- Loosening, deformation or fracture of the implant
- Acute post-operative wound infections and late infections with possible sepsis
- Migration, subluxation of the implant with resulting reduction in range of movement
- Fractures resulting from unilateral joint loading
- Thrombosis and embolism
- Wound hematoma and delayed wound healing
- Temporary and protracted functional neurological perturbation
- Tissue reactions as the result of allergy or foreign body reaction to dislodged particles

- Corrosion with localized tissue reaction and pain
- Pain, a feeling of malaise or abnormal sensations due to the implant used
- Bone loss due to stress shielding

All possible complications listed here are not typical of Paragon 28®, Inc. products but are in principle observed with any implant. Promptly inform Paragon 28® as soon as complications occur in connection with the implants or surgical instruments used. In the event of premature failure of an implant in which a causal relationship with its geometry, surface quality or mechanical stability is suspected, please provide Paragon 28® with the explant(s) in a cleaned, disinfected and sterile condition. Paragon 28® cannot accept any other returns of used implants. The surgeon is held liable for complications associated with inadequate asepsis, inadequate preparation of the osseous implant bed in the case of implants, incorrect indication or surgical technique or incorrect patient information and consequent incorrect patient behavior.

WARNINGS AND PRECAUTIONS

- Re-operation to remove or replace implants may be required at any time due to medical reasons or device failure. If corrective action is not taken, complications may occur.
- Use of an undersized screw in areas of high functional stresses may lead to implant fracture and failure.
- Plates and screws, wires, or other appliances of dissimilar metals should not be used together in or near the implant site.
- The implants and guide wires are intended for single use only. Re-use may cause product failure and could lead to disease transmission.
- Instruments, guide wires and screws are to be treated as sharps.
- **Do not use other manufacturer's instruments or implants in conjunction with the Monster® Screw System.**

MR SAFETY INFORMATION

The Monster® Screw System has been evaluated for safety and compatibility in the MR environment. It has not been tested for heating, migration or image artifact in the MR environment. The safety of the Monster® Screw System in the MR Environment is unknown. Scanning a patient who has this device may result in patient injury.



PATENTED, DESIGNED & EXCLUSIVELY DISTRIBUTED BY



P51-STG-3011 RevA [2023-02-10]

™Trademarks and ®Registered Marks of Paragon 28®, Inc.

© Copyright 2023 Paragon 28®, Inc. All rights reserved.

Patents: www.paragon28.com/patents

Paragon 28, Inc. 🏢
14445 Grasslands Dr.
Englewood, CO 80112 USA
(855) 786-2828

Australian Sponsor
Emergo Australia
201 Sussex Street
Level 20, Tower II, Darling Park
Sydney, NSW 2000 Australia

DISCLAIMER

The purpose of the SILVERBACK™ Ankle Fusion Plating System Surgical Technique Guide is to demonstrate the optionality and functionality of the SILVERBACK™ Ankle Fusion Plating System and Gorilla® R3CON Plating System. Although variations in placement and use of the SILVERBACK™ Ankle Fusion Plating System can be performed, the fixation options demonstrated in this technique were chosen to demonstrate the functionality of the system and for simplicity of explanation. Other uses for the SILVERBACK™ Ankle Fusion Plating System can be employed, appropriate for the size of the device. Federal law (U.S.A.) restricts this device to sale and use by, or on order of, a physician.

www.Paragon28.com