

GORILLA[®] ANKLE FRACTURE 360[™]

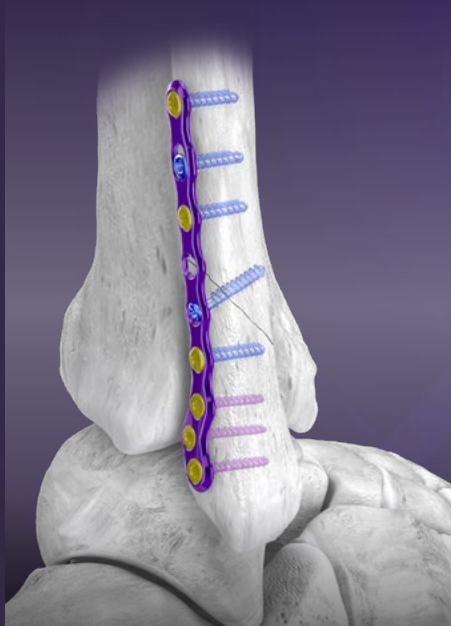
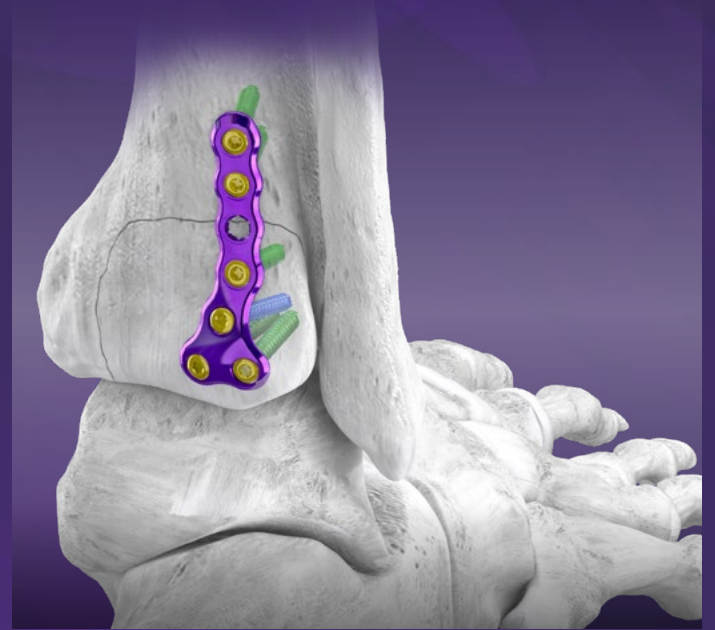

SURGICAL TECHNIQUE GUIDE
Ankle Fracture Plating System

Exclusively foot & ankle
Paragon[®] 20

PRODUCT DESCRIPTION

Paragon 28® designed the Gorilla® Ankle Fracture Plating System to allow surgeons versatility in fixation selection for ankle fractures. The system has 78 plate options for fracture fixation of the distal fibula and tibia. While some plating families tend to be more anatomic and directed in their placement, other plates are intended to allow surgeons flexibility in their location. All circular plate holes accept 2.7 mm, 3.5 mm and 4.2 mm locking and non-locking screws. Most plate holes have a built-in recess for placement of a syndesmotic device or to allow a screw that is off-axis to have reduced screw head prominence.

A Ø3.5 mm Compact Screw is available in locking and locking screws in 10-40 mm lengths to address dense bone in the proximal tibia and fibula. The Compact Screw was designed with a smaller thread height to help reduce insertion torque in dense bone. Additionally, single lead bone threads result in a decreased pitch differential between the locking screw head and bone threads to reduce the amount of insertion torque required to lock the screw into the plate in areas of dense bone.

Instrumentation is included in the Gorilla® Ankle Fracture Plating System that facilitates reduction and fixation of ankle fractures. Use of this instrumentation is shown throughout the technique guide within some of the techniques for the 13 plating families. The page number for specific instruments and implant techniques is outlined in the table of contents below.

TABLE OF CONTENTS

Implants: Plate Families	3-5
Featured System Instrumentation	6-9
Medial Malleolus Plate	10
FEATURING: Placement of Gorilla® Screws	
Straight Fibular Plate	11
FEATURING: Use of a Gorilla® Non-Locking Screw	
Anatomic Fibular Plate	12-13
FEATURING: Syndesmotic Tenaculum Clamp	
Medial Malleolus K-wire Guide	14
Posterior Fibular Plate	15
FEATURING: Plate Positioning Tower	
Posteromedial Tibia Plate	16
Trimalleolar Tibia Plate	17
Posterolateral Tibia Plate	18
Medial Malleolus Hook Plate	19-20
Straight Fibular Hook Plate	21-22
FEATURING: Double Tamp	
Anatomic Fibula Hook Plate	23-24
FEATURING: Hook Screw Drill Guide	
Anterior Distal Tibial Plate	25-26
Anterolateral and Medial Distal Tibia Plates	27-30
Caddy Layout	31
Indications, Contraindications, and Warnings	32-34

ACKNOWLEDGMENTS: Paragon 28® would like to thank Christopher Zingas, M.D. and Aaron Perdue, M.D. for their contribution to the development of the surgical technique guide.

ANKLE FRACTURE PLATES

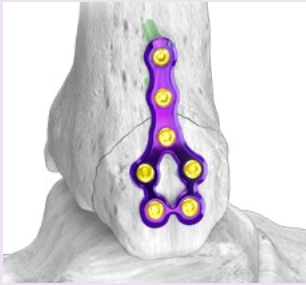

Medial Malleolus Plate

- Plate designed to address vertical shear fractures and medial malleolar osteotomies

Available in a 7 hole plate



Straight Fibular Plate

- Plate optionality and malleability provides a plating solution for a variety of fracture types and patterns

Available in 3-10 hole, 12 hole, 14 hole, and 16 hole plates

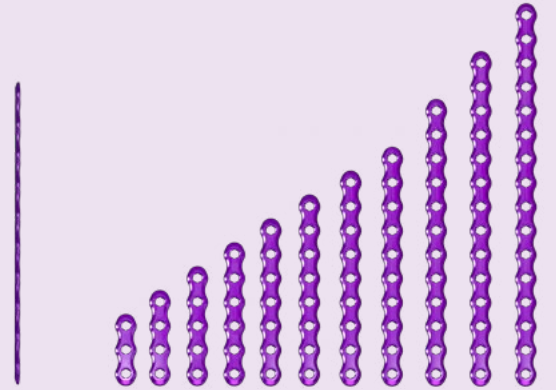

Anatomic Fibular Plate

- Distal screw cluster allows for multiple fixation points in the lateral malleolus

Available in 7 hole, 9 hole, 11 hole, 13 hole, 15 hole, and 17 hole right and left side specific plates

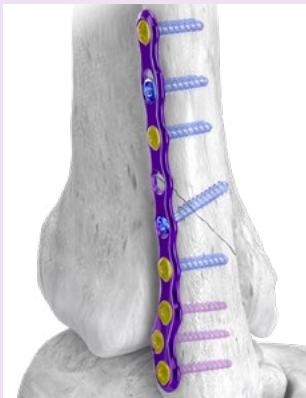
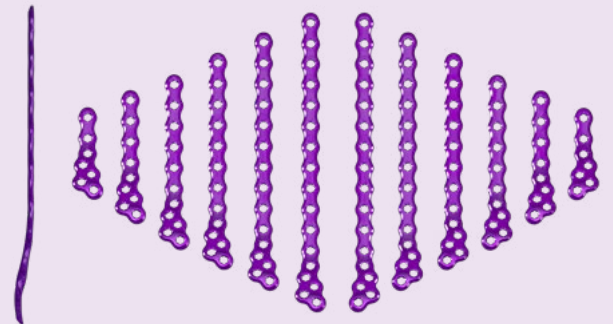

Posterior Fibular Plate

- Plate optionality provides incision and fracture based configurations for the posterior, posterolateral and lateral fibula

Available in 7 hole, 9 hole, and 11 hole alpha and beta plates

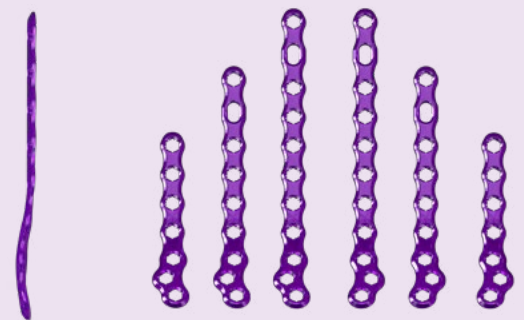

Posteromedial Tibia Plate

- Contoured to the posteromedial tibia to treat posterior pilon variant fractures

Available in 6 hole and 8 hole right and left side specific plates

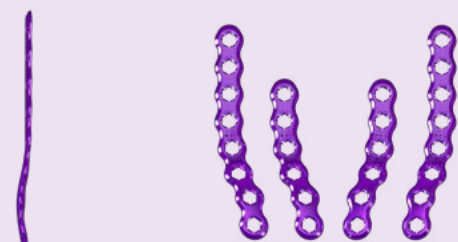

ANKLE FRACTURE PLATES



Trimalleolar Tibia Plate

- Slight concavity allows for plate placement posteriorly on the tibia with little to no bending
- Plate helps guard against superior translation of the posterior tibia fracture fragment in trimalleolar fractures

Available in 3 hole and 4 hole plates

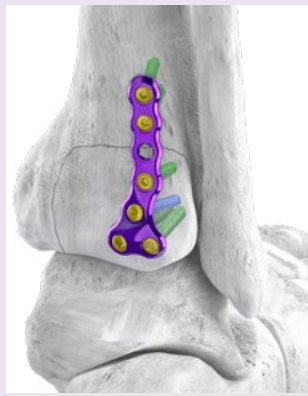
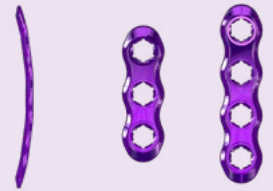

Posterolateral Tibia Plate

- Contoured to the posterolateral tibia to treat posterior pilon variant fractures or large trimalleolar posterior tibia fragments
- Two most distal screw holes are angled superiorly to avoid the dome of the tibial plafond

Available in 5 hole, 6 hole, 7 hole, and 8 hole right and left side specific plates



Straight Fibular Hook Plate

- Hooks are designed to support a comminuted lateral malleolus or avulsion fragment

Available in 5 hole and 6 hole plates



Anatomic Fibular Hook Plate

- Distal screw cluster allows for crossing screw placement through hooks to provide support and additional fixation to distal fragment

Available in 5 hole and 6 hole right and left side specific plates



Medial Malleolus Hook Plate

- Intended for fixation of comminuted or small fractures of the medial malleolus that may not be conducive to lag screw fixation

Available in 2 hole and 4 hole plates



ANKLE FRACTURE PLATES



Anterior Distal Tibia Plate

- Nine hole distal cluster helps maximize capture of distal fracture fragments, while transitional thickness above this cluster helps provide increased strength and stability

Available in 11 hole, 13 hole, and 15 hole plates

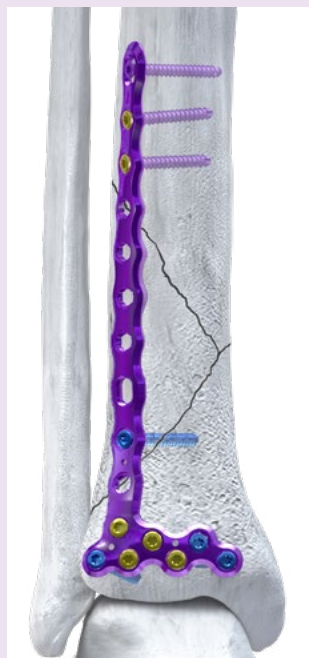
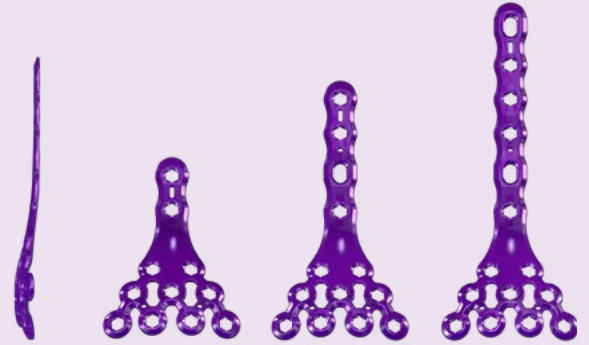

Anterolateral Distal Tibia Plate

- Seven hole distal cluster is anatomically contoured to capture distal fragments, while proximal plate curves to mate with the anterior surface of the tibia

Available in 4 hole, 6 hole, 8 hole, 10 hole, 12 hole, 14 hole, 16 hole, and 18 hole right and left side specific plates

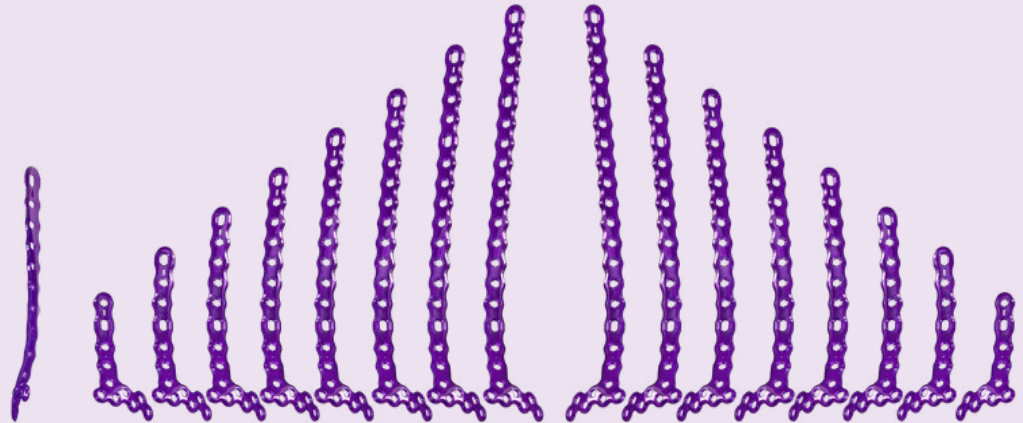







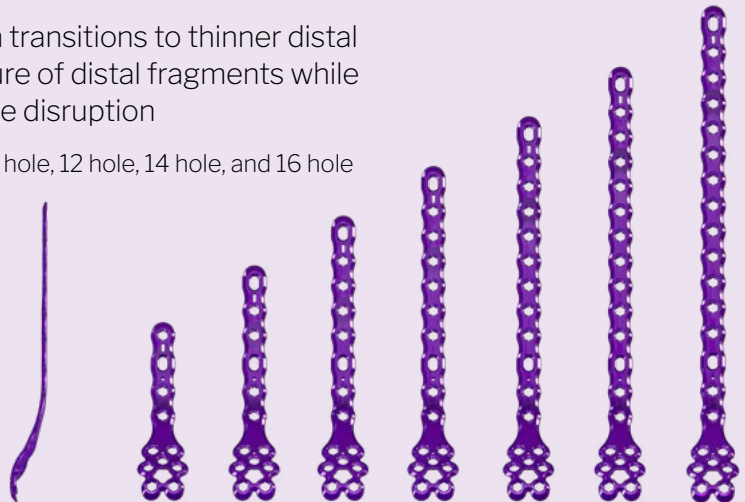









































Medial Distal Tibia Plate









- Thicker proximal section transitions to thinner distal cluster to allow for capture of distal fragments while helping to limit soft tissue disruption

Available in 4 hole, 6 hole, 8 hole, 10 hole, 12 hole, 14 hole, and 16 hole



SCREW OFFERING AND INSTRUMENTATION MATRIX

	Ø2.7 mm R3CON Screws	Ø3.5 mm R3CON Screws	Ø4.2 mm R3CON Screws	Ø3.5 mm Compact Screws
Locking:				
Non-locking:				
Screw Lengths:	8 mm - 20 mm in 1 mm increments 20 - 54 mm in 2 mm increments	8 mm - 60 mm in 2 mm increments 60 - 70 mm in 5 mm increments 70 - 100 mm in 10 mm increments (Non-locking ONLY)	8 mm - 60 mm in 2 mm increments 60 mm - 70 mm in 5 mm increments	10 mm - 40 mm in 2 mm increments
Drill Size:	 Ø2.0 mm	 Ø2.4 mm	 Ø2.8 mm	 Ø2.8 mm
Driver Size:	 HX-10	 HX-10	 HX-10	 HX-10
Locking Drill Guide Size:	 Ø2.7 mm	 Ø3.5 mm	 Ø3.5 mm C / Ø4.2 mm	 Ø3.5 mm C / Ø4.2 mm
Centering Drill Guide Size:	 Ø2.7 mm	 Ø3.5 mm	 Ø4.2 mm	 Ø3.5 mm
Compression Slot Drill Guide Size:	 Ø2.7 mm	 Ø3.5 mm	 Ø3.5 mm C / Ø4.2 mm	 Ø3.5 mm C / Ø4.2 mm
Cone/Straight Easy Guide Size:	 Ø2.7 mm	 Ø3.5 mm	 Ø3.5 mm C / Ø4.2 mm	 Ø3.5 mm C / Ø4.2 mm
Tap Size:	 Ø2.7 mm	 Ø3.5 mm	 Ø4.2 mm	 Ø3.5 mm C
OverDrill Size:	 Ø2.7 mm	 Ø3.5 mm	 Ø4.2 mm	 Ø3.5 mm C
Double Ended Drill / Over Drill Guides:	 Ø2.0 mm	 Ø2.4 mm	 Ø2.8 mm	 Ø2.8 mm
Drill Sleeve (for use with Double Ended Guide):	 Ø2.0 mm Drill / Ø2.7 mm Over Drill	 Ø2.4 mm Drill / Ø3.5 mm Over Drill	 Ø2.8 mm Drill / Ø4.2 mm Over Drill	 Ø2.8 mm Drill / Ø4.2 mm Over Drill

	Ø4.0 mm Mini-Monster Cannulated Screws
Headed, Long Thread:	
Screw Lengths:	24 mm - 50 mm in 2 mm increments 50 mm - 60 mm in 5 mm increments
Drill Size:	 Ø2.6 mm
Driver Size:	 HX-10
Drill Guide Size:	 Ø4.0 mm
Headed Countersink Size:	 Ø4.0 mm
Tap Size:	 Ø4.0 mm
Over Drill Size:	 Ø4.0 mm
Over Drill Guide Size:	 Ø4.0 mm
K-wire Size:	 Ø1.2 mm x 15 cm

Ø3.5 mm C = Ø3.5 mm Compact Thread Screws

FEATURED SYSTEM INSTRUMENTATION

Medial Malleolus K-wire Guide



Hook Plate Single Tamp



Hook Plate Double Tamp



Hook Plate Screw Drill Guide



Drill Sleeve for use with Drill / Over Drill Guide



Drill/Over Drill Guide

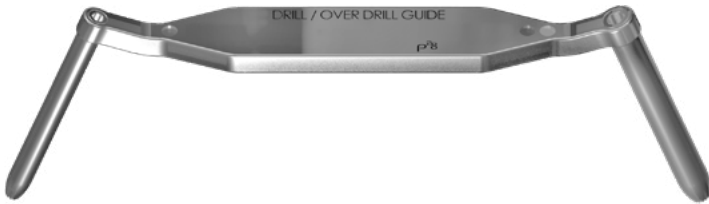

Easy Cone Drill Guide



Threaded Bending Bar (2 of each included)



Plate Bending Irons (2 of each included)

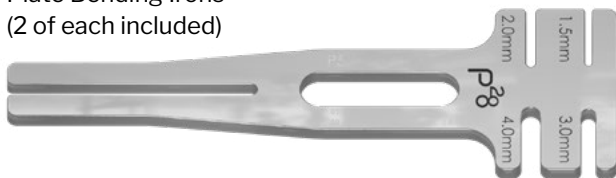

Plate Positioning Tower, Long



Plate Positioning Tower



Locking Drill Guide



Compression Slot Drill Guide



Centering Drill Guide



Screw Holding Sleeve



Medial Hook Plate Drill Guide Available Upon Request



Lateral Hook Plate Drill Guide Available Upon Request



Hook Plate Inserter Available Upon Request



AO Handle



Mini AO Handle



Plate Bending Pliers

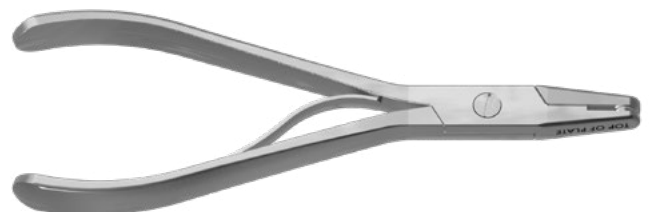

FEATURED SYSTEM INSTRUMENTATION

Standard Depth Gauge



Percutaneous Depth Gauge



Wires	Quantity
P28, K-Wire Hole Gauge & Ruler, SS	1
Ø1.60mm x 15cm Smooth, K-Wire	8
Ø2.0mm x 15cm Smooth, K-Wire	8
Ø2.0mm x 20cm Smooth, K-Wire	8
Ø1.60mm x 15cm Threaded, K-Wire	8
Ø2.0mm x 15cm Threaded, K-Wire	8
Ø2.0mm x 20cm Threaded K-Wire	8
Ø1.60mm X 8cm Olive Wire, Smooth, 316 LVM	6
Ø1.60mm X 10cm Olive Wire, Smooth, 316 LVM	6
Ø1.60mm X 8cm Olive Wire, Threaded, 316 LVM	6
Ø1.60mm X 10cm Olive Wire, Threaded, 316 LVM	6

Ø1.60 mm x 10 cm Long Olive Wire



Ø1.60 mm x 8 cm Long Olive Wire



Ø1.60 mm x 15 cm Smooth K-Wire



Ø1.60 mm x 15 cm Threaded K-Wire



JOINT PREPARATION INSTRUMENTATION

Ribbon Retractors (2 of each included)



Hohmann Retractors (2 of each included)



Langenbeck Elevator



Periosteal Elevator



FRACTURE REDUCTION INSTRUMENTATION

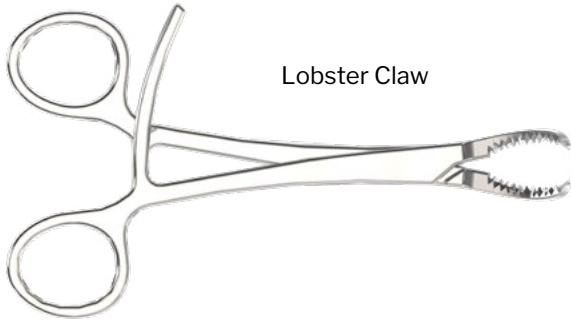

Lobster Claw



Large Lobster Claw Clamp

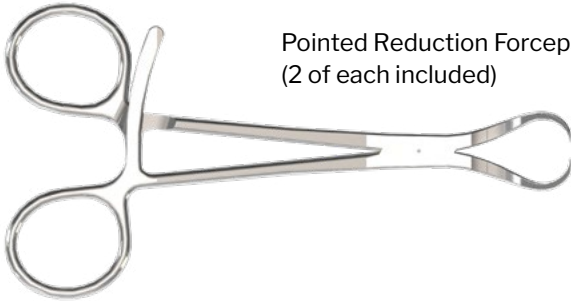

Pointed Reduction Forceps
(2 of each included)

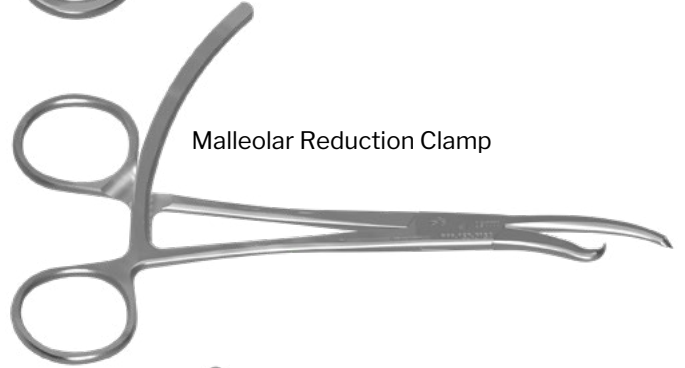

Malleolar Reduction Clamp

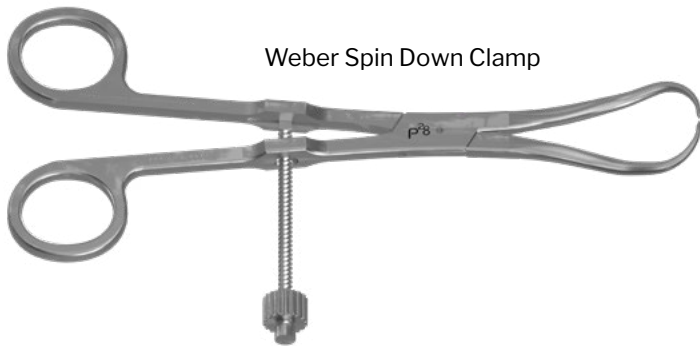

Weber Spin Down Clamp

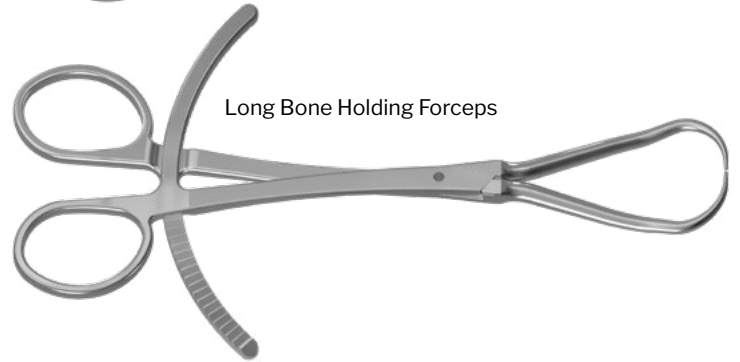

Long Bone Holding Forceps

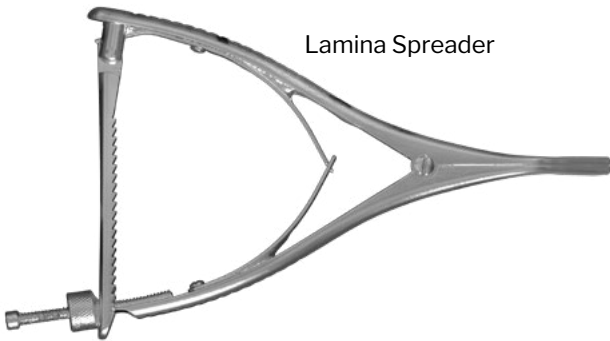

Lamina Spreader

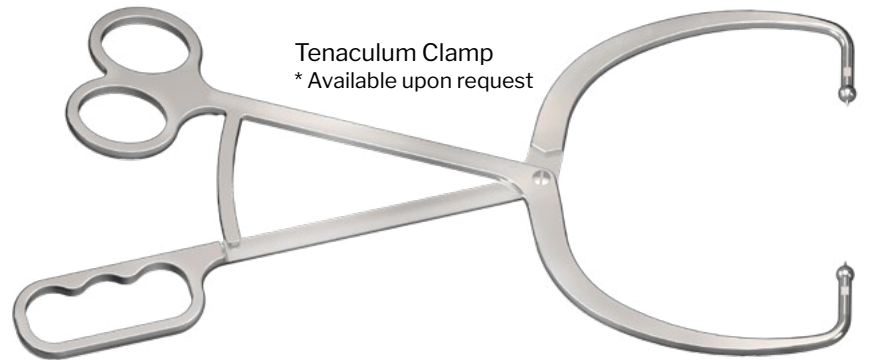

Tenaculum Clamp
* Available upon request

MEDIAL MALLEOLUS PLATE FEATURING: PLACEMENT OF GORILLA® SCREWS

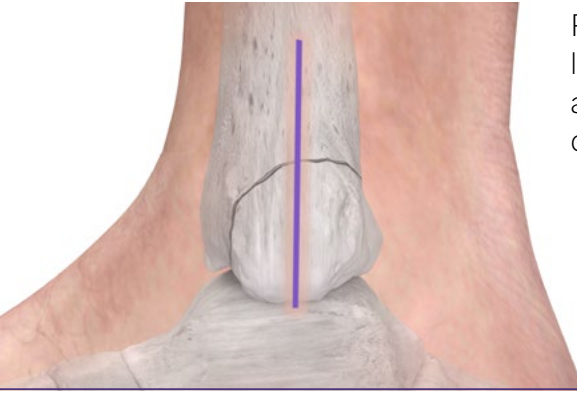

Patient is positioned supine such that the foot is near the end of the table. A longitudinal incision is made over the central aspect of the medial malleolus, appropriately sized for the fracture and plate length. Continue soft tissue dissection until the fracture site is visible.



The fracture site is cleared and refreshed. Fracture reduction is performed and temporary stabilization is achieved using a K-wire, Malleolar Reduction Clamp (shown), Pointed Reduction Forceps or Lobster Claw Clamp, per surgeon preference. Alternatively, the Malleolus Clamp can be used for fracture reduction.

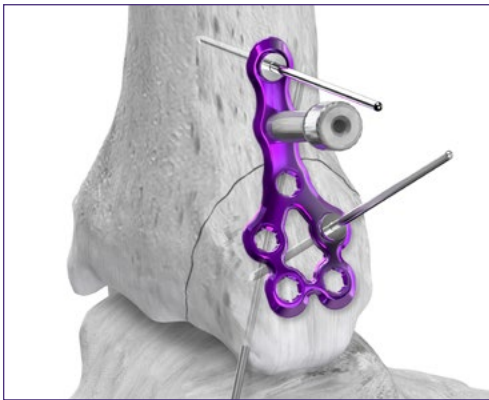

Retrieve the Medial Malleolus Plate. Place a threaded drill tower on the proximal aspect of the plate. Secure the plate to the medial malleolus using 1-2 Olive Wires. Confirm plate placement using fluoroscopy.

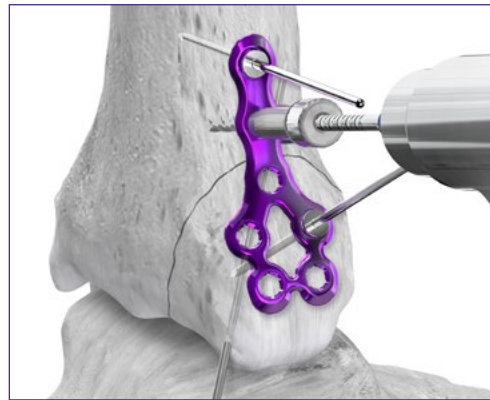

All plate holes accept 2.7 mm, 3.5 mm or 4.2 mm locking or non-locking screws. Drill through the threaded drill tower using the drill sized for the desired screw diameter. Remove the threaded drill tower.

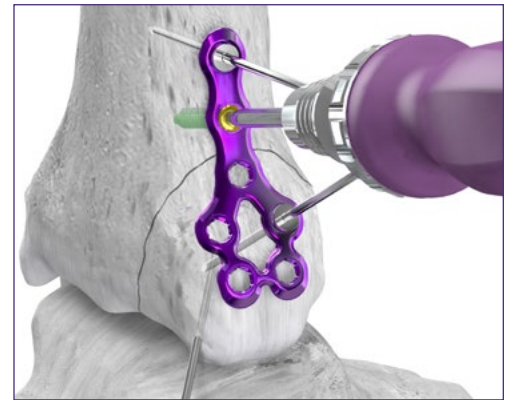

Measure screw length using a depth gauge. Insert the selected screw into the drilled hole in the tibia. Confirm screw position and length using fluoroscopy.

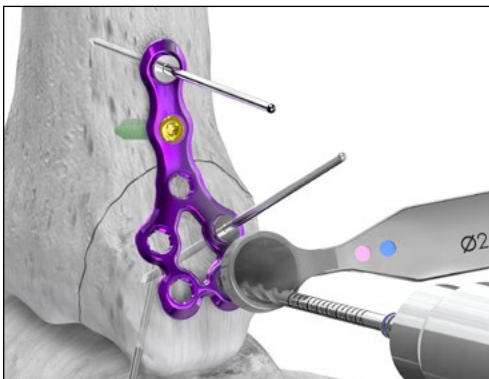

Locking screws have the ability to be placed off-axis 15° in any direction. The cone end of the Easy Cone Drill Guide can be used to limit drilling to 15° in any direction. Drill in desired direction.

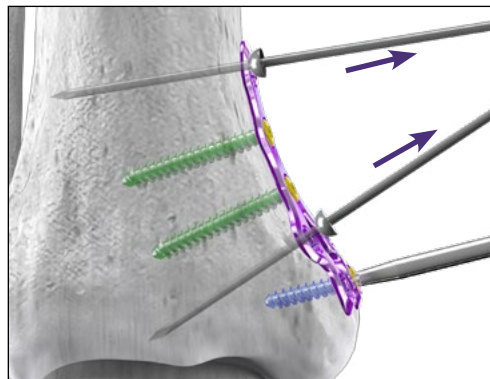

Measure screw length using a depth gauge. Insert the selected screw into the drilled hole in the medial malleolus. Remove Olive Wires. Repeat the steps above to fill the remaining screw holes. The same steps are used regardless if a locking or non-locking screw is used.

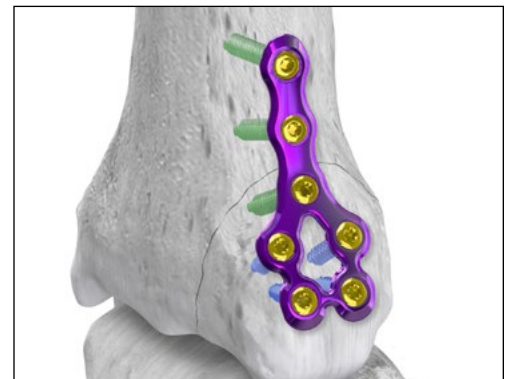

Confirm plate and screw placement using fluoroscopy. Proceed to incision closure or adjunctive procedures at this time.

STRAIGHT FIBULAR PLATE FEATURING: USE OF A GORILLA® NON-LOCKING SCREW



Patient is positioned supine such that the foot is near the end of the table, or in lateral decubitus, based on surgeon preference or fracture extent. A longitudinal incision is made over the central aspect of the fibula, appropriately sized for the fracture pattern and anticipated plate length. Continue soft tissue dissection until the fracture site is visible.



The fracture site is cleared and refreshed. Fracture reduction is performed and temporary stabilization is achieved using a K-wire, Pointed Reduction Forceps (shown), or Lobster Claw Clamp, per surgeon preference

In this instance, a Ø3.5 mm fully threaded non-locking Gorilla R3CON Solid screw is used as a lag screw across the fracture site prior to plate placement.

Option 1:



Use the 3.5 mm Over Drill and Over Drill Guide to perform a lag by drilling technique. Do not violate the fracture line with the Over Drill.



While maintaining position of the Over Drill Guide, slide the Drill Sleeve into the Over Drill Guide and drill with the Ø2.4 mm Drill bi-cortically. Measure screw length using the provided standard Gorilla Depth Gauge.

Option 2:



Use the 3.5 mm Over Drill and Over Drill Guide to perform a lag by drilling technique. Do not violate the fracture line with the Over Drill.

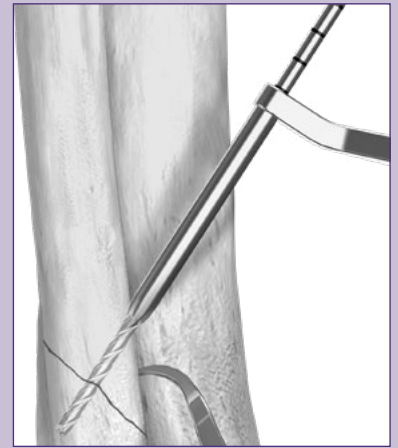

Flip the Drill/Over Drill Guide and drill through the Drill Guide with the Ø2.4 mm Drill. Drill across the fracture line bi-cortically. Measure screw length using the provided standard Gorilla Depth Gauge.

Insert the Ø3.5 mm Gorilla R3CON Solid Screw.

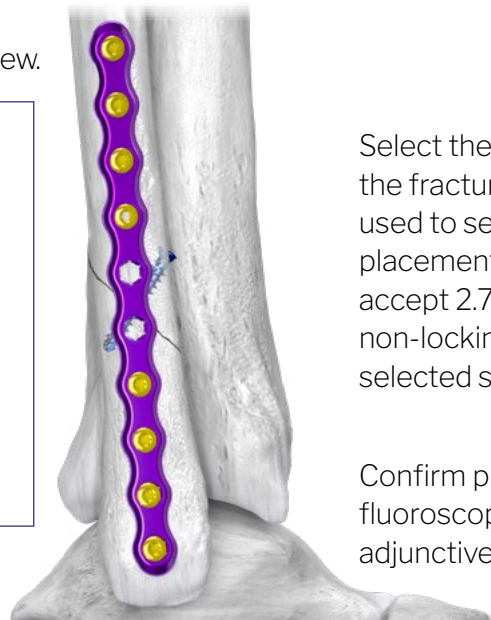

Select the appropriate Straight Fibular Plate for the fracture type and size. Olive Wires can be used to secure the plate to bone. Confirm plate placement using fluoroscopy. All plate holes accept 2.7 mm, 3.5 mm or 4.2 mm locking or non-locking screws. Fill desired plate holes with selected screw sizes.

Confirm plate and screw placement using fluoroscopy. Proceed to incision closure or adjunctive procedures at this time

ANATOMIC FIBULAR PLATE FEATURING: SYNDESMOTIC TENACULUM CLAMP

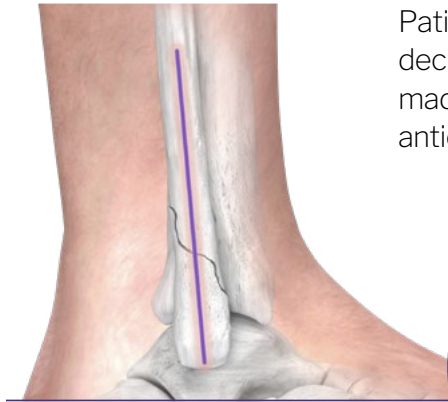

Patient is positioned supine such that the foot is near the end of the table, or in lateral decubitus, based on surgeon preference or fracture extent. A longitudinal incision is made over the central aspect of the fibula, appropriately sized for the fracture pattern and anticipated plate length. Continue soft tissue dissection until the fracture site is visible.



The fracture site is cleared and refreshed. Fracture reduction is performed and temporary stabilization is achieved using a K-wire, Pointed Reduction Forceps (shown), or Lobster Claw Clamp, per surgeon preference.

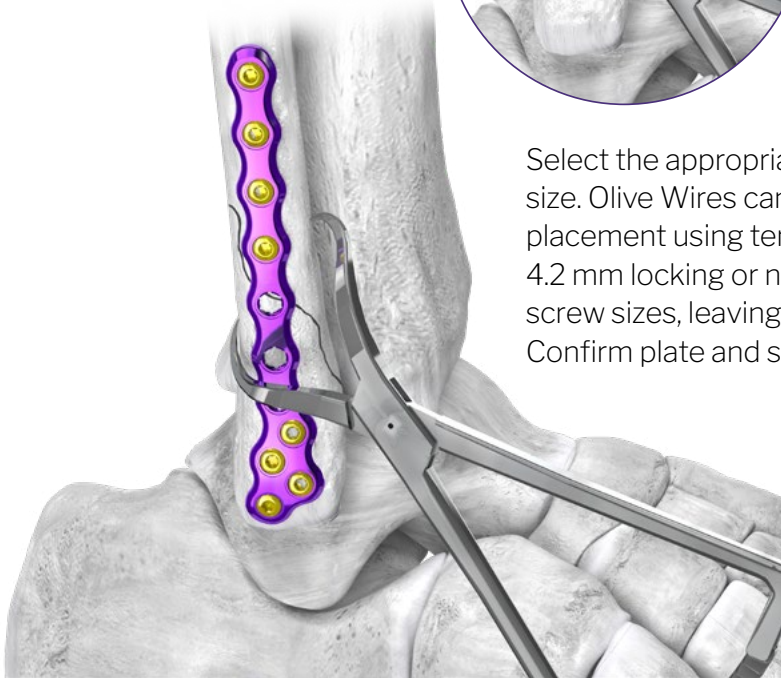

Select the appropriate Anatomic Fibular Plate for the fracture type and size. Olive Wires can be used to secure the plate to bone. Confirm plate placement using temporary fixation. All plate holes accept 2.7 mm, 3.5 mm or 4.2 mm locking or non-locking screws. Fill desired plate holes with selected screw sizes, leaving one or two screw holes empty for syndesmotic fixation. Confirm plate and screw position using fluoroscopy.

If syndesmotic fixation is necessary, a Syndesmotic Tenaculum Clamp is available upon request to assist in reduction of the syndesmosis. A small stab incision is made over the medial malleolus with blunt dissection carried down to bone. Place the BB-Tak portion of the clamp into the medial incision and into the lateral malleolus. Reduction of the syndesmosis is performed by closing the handles together and allowing the ratcheting mechanism to maintain position of the clamp once appropriate reduction is achieved.

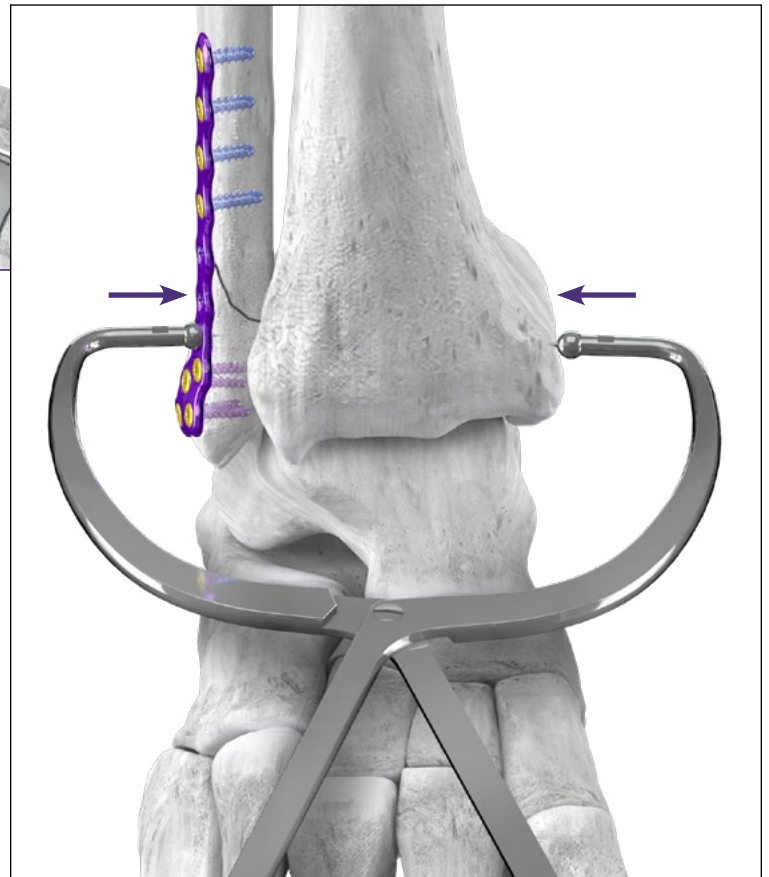

ANATOMIC FIBULAR PLATE FEATURING: SYNDESMOTIC TENACULUM CLAMP

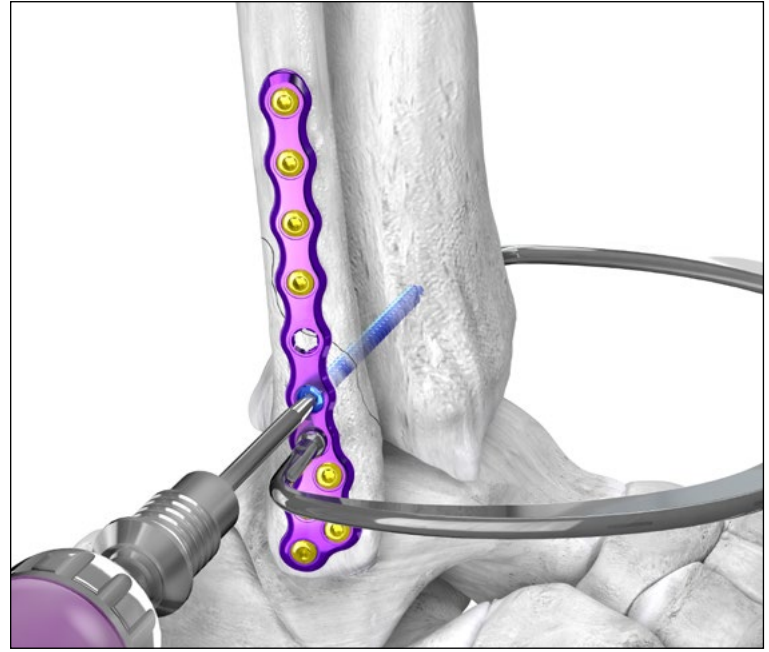
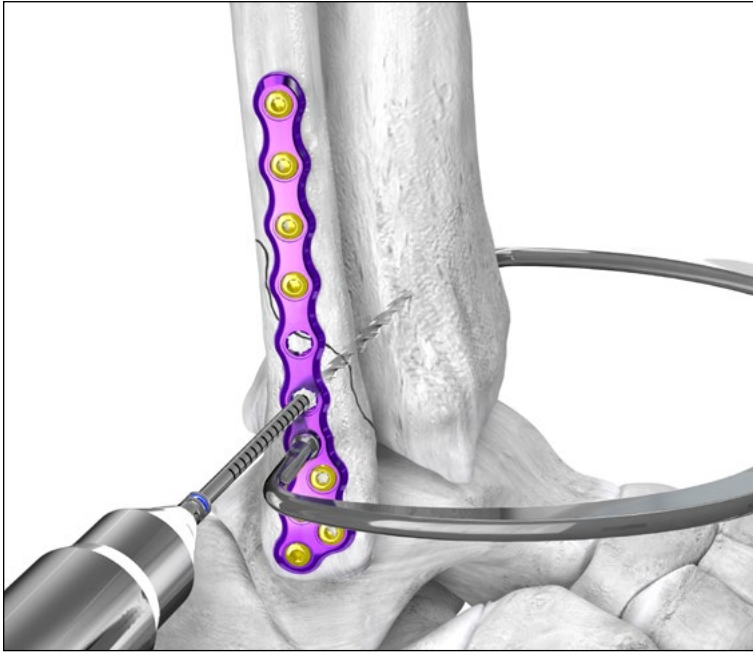

Placement of one or two syndesmotic screws can be performed following reduction of the syndesmosis. A Gorilla R3CON 3.5 mm is shown for syndesmotic fixation. A non-locking screw should be used if greater than 15° of off-axis drilling is performed. Drill 3-4 cortices using the drill for desired screw size.

Measure screw length using a depth gauge. Insert the selected screw. Confirm screw length and placement using fluoroscopy. Remove the syndesmotic Tenaculum Clamp to allow space to place a second syndesmotic screw.

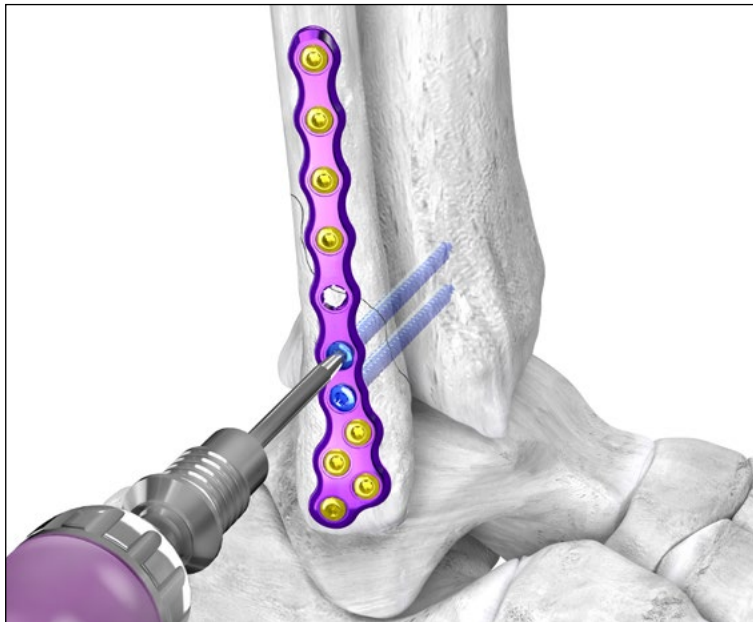

Repeat steps above if placing a second syndesmotic screw.

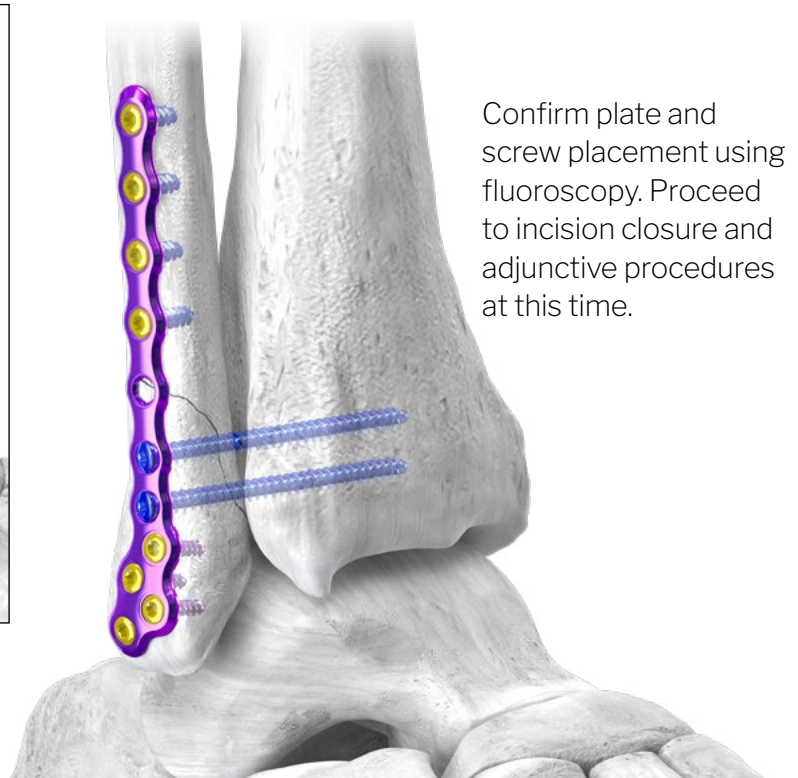

Confirm plate and screw placement using fluoroscopy. Proceed to incision closure and adjunctive procedures at this time.

MEDIAL MALLEOLUS K-WIRE GUIDE

For medial malleolus fractures that require screw fixation only, the Medial Malleolus K-wire Guide allows for K-wire placement that is parallel or converging, depending on surgeon preference. Both sides of the K-wire Guide are designed to allow for 4.0 mm or smaller Mini-Monster screws to be inserted into the medial malleolus without colliding.

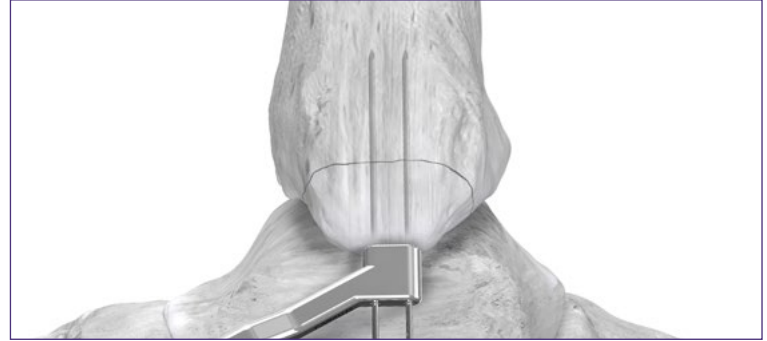
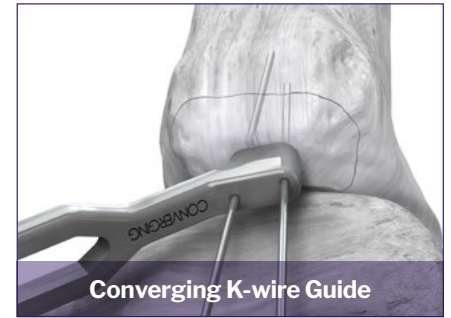
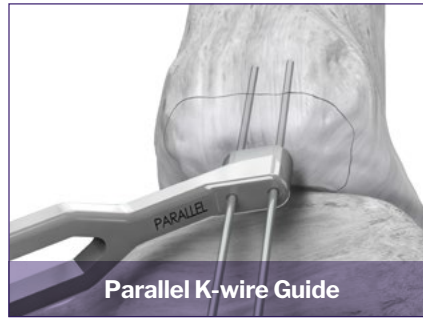

After fracture reduction and temporary fixation of the fracture, retrieve the Medial Malleolus K-wire Guide. Position the selected side (Parallel or Converging) against the distal aspect of the medial malleolus at the desired K-wire entry position.

Insert two K-wires into the guide and confirm K-wire placement using fluoroscopy.



NOTE



Alternatively, a single K-wire can be placed freehand into the medial malleolus using fluoroscopy.

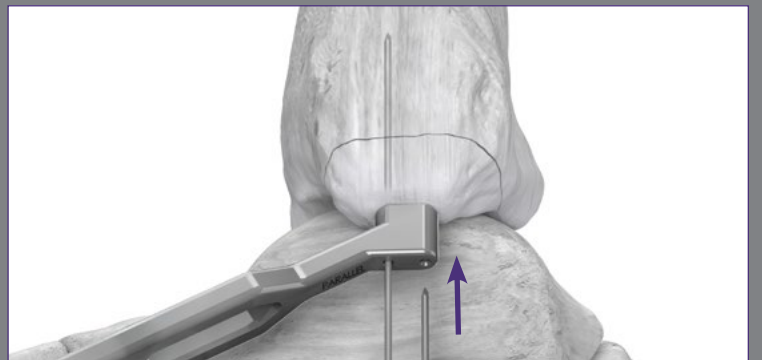

If position of wire is appropriate after checking under fluoroscopy, the K-wire Guide can be slid over the original wire such that the empty hole is anterior or posterior to the original K-wire. The second K-wire is then placed.

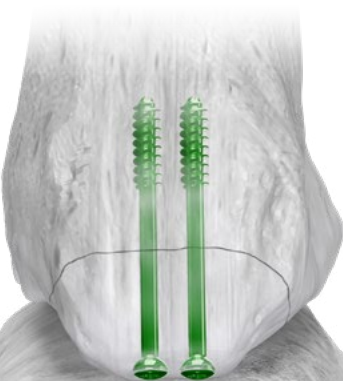

Using standard cannulated screw insertion techniques, place two 4.0 mm partially threaded Mini-Monster screws into the medial malleolus. Confirm position and length of screws using fluoroscopy. Remove K-wires serving as temporary fixation. Proceed to incision closure and adjunctive procedures at this time.

POSTERIOR FIBULAR PLATE FEATURING: PLATE POSITIONING TOWER



Posterior or posterolateral plate placement can be achieved through a lateral or a posterior incision. Incision placement and patient positioning may be dependent on fibular fracture pattern and the presence and extent of a tibial fracture and planned fixation.

A lateral incision (shown) may require supine or lateral decubitus patient position with the foot near the end of the table. For a posterior incision, the patient is positioned in the lateral decubitus position or prone, per surgeon preference. Soft tissue dissection is carried down until the fracture site is visible. Retract the peroneal tendons to allow for plate and screw placement.



NOTE

The Plate Positioning Tower helps the surgeon to place Olive Wires through the plate holes in the fibula that are centered, allowing the plate to stay in the intended position on this narrow bone. When Olive Wires are placed that are not perfectly centered, the plate can shift to meet the Olive Wire.

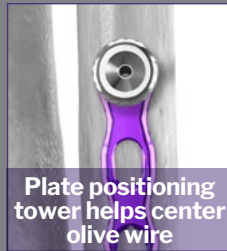

Plate positioning tower helps center olive wire



Helps prevent plate shifting



Olive Wire not centered

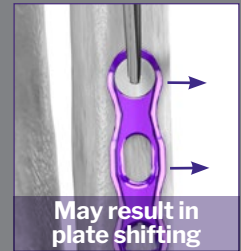

May result in plate shifting



The fracture site is cleared and refreshed. Fracture reduction is performed and temporary stabilization is achieved using a K-wire, Pointed Reduction Forceps or Lobster Claw Clamp, per surgeon preference.

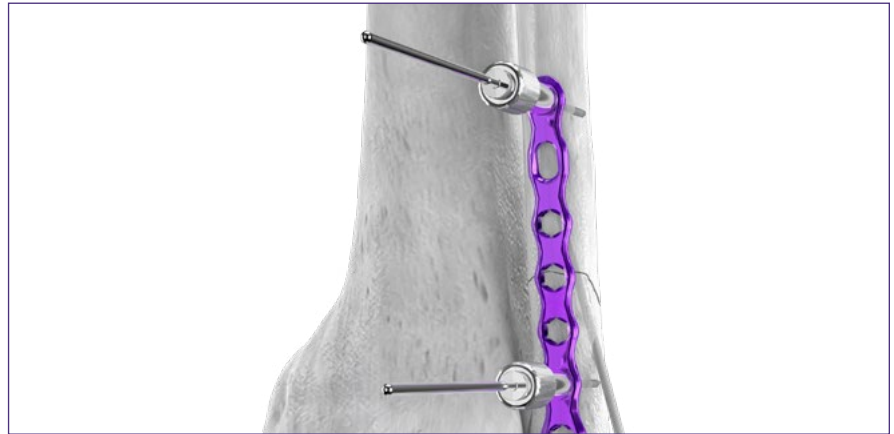

Select the appropriate Posterior Fibular Plate for the fracture type and size. Affix the Plate Positioning Tower to the plate at the proximal aspect. Retrieve a long Olive Wire. Use the long Olive Wire through the Plate Positioning Tower to temporarily fix the plate to the fibula, while maintaining intended plate position. A second Plate Positioning Tower and long Olive Wire can be used distally to temporarily secure the plate to bone.

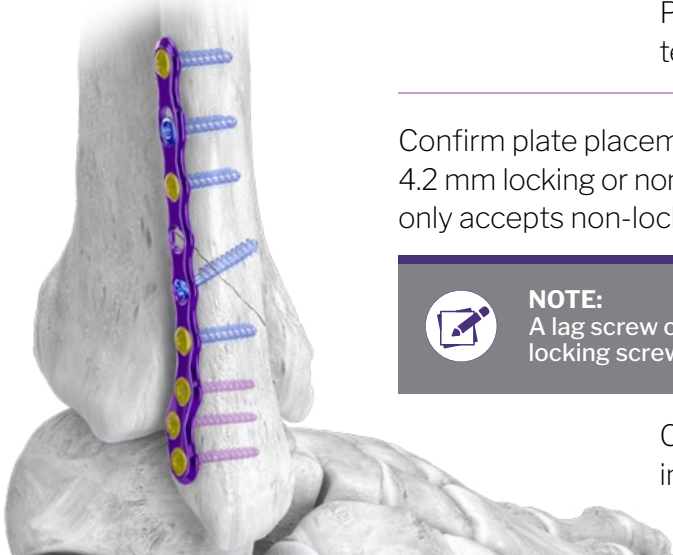

Confirm plate placement using fluoroscopy. All plate holes accept 2.7 mm, 3.5 mm or 4.2 mm locking or non-locking screws, with the exception of the compression slot, which only accepts non-locking screws.



NOTE:

A lag screw can be placed across the fracture through the plate in this instance. A non-locking screw can be used with overdrilling of the near cortex. Fill remaining plate holes.

Confirm plate and screw placement using fluoroscopy. Proceed to incision closure or adjunctive procedures at this time.

POSTEROMEDIAL TIBIA PLATE

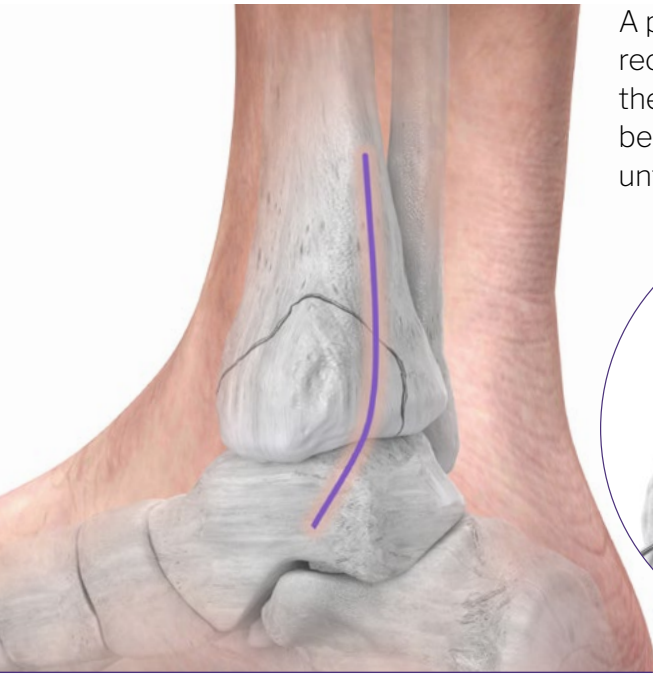

A posteromedial approach for use with the Posteromedial Tibia Plate is recommended. Prone patient positioning with the foot near the end of the table is recommended. The soft tissue interval for deep dissection will be dependent on fracture pattern. Soft tissue dissection is carried down until the fracture site is visible.



The fracture site is cleared and refreshed. Fracture reduction is performed and temporary stabilization is achieved using a K-wire or clamp, per surgeon preference.

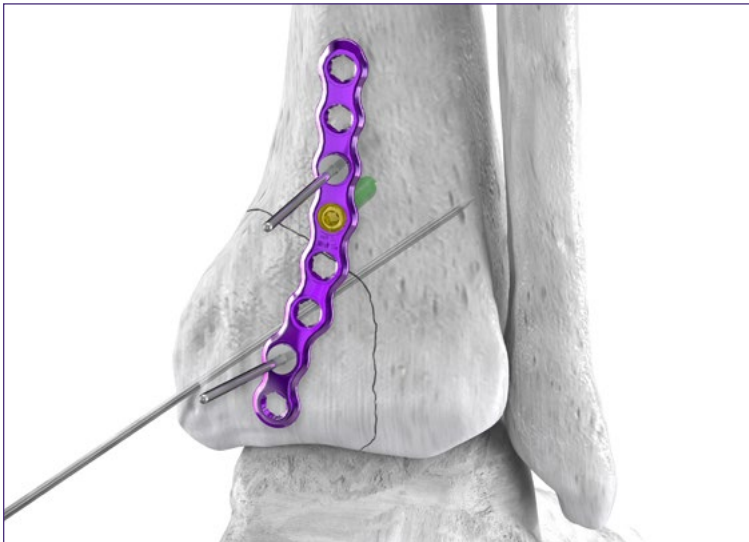

Select the appropriate Posteromedial Tibia Plate for the fracture type and size. Temporarily fix the plate to the posterior tibia by placing 1-2 Olive Wires.

Confirm plate placement using fluoroscopy.

All plate holes accept 2.7 mm, 3.5 mm or 4.2 mm locking or non-locking screws. Place a proximal plate screw above the fracture to secure the plate to the bone.

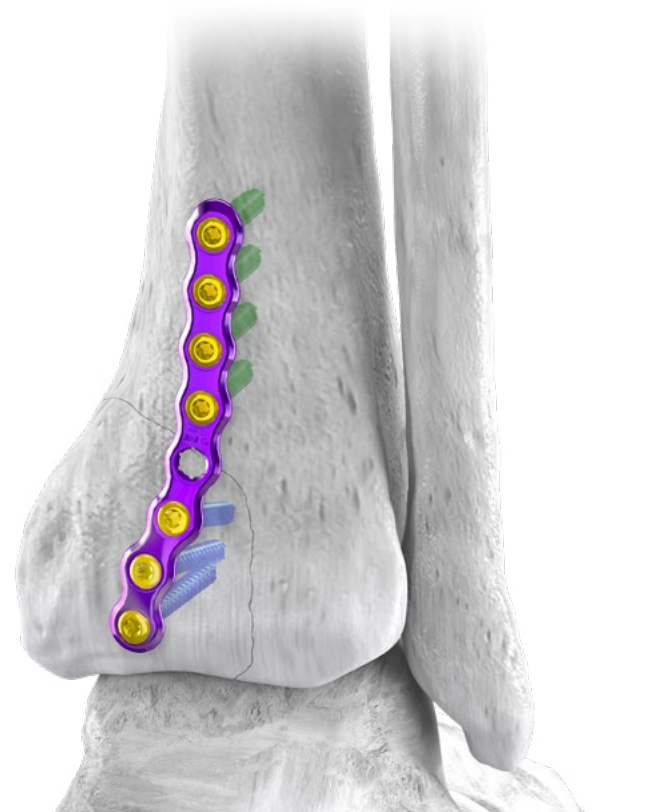

Continue screw placement into desired screw holes. Confirm plate and screw placement using fluoroscopy. Proceed to additional fracture fixation, incision closure or adjunctive procedures at this time.

TRIMALLEOLAR TIBIA PLATE

A posterolateral approach for posterior malleolar fixation using a plate is typically used. A posterolateral incision may require a lateral decubitus or prone patient position with the foot near the end of the table. Soft tissue dissection is carried down until the fracture site is visible.



The fracture site is cleared and refreshed. It is important to preserve the Posterior Inferior Tibiofibular Ligament (PITFL) attachment to the fracture fragment. Fracture reduction is performed and temporary stabilization is achieved using a K-wire or clamp, per surgeon preference.

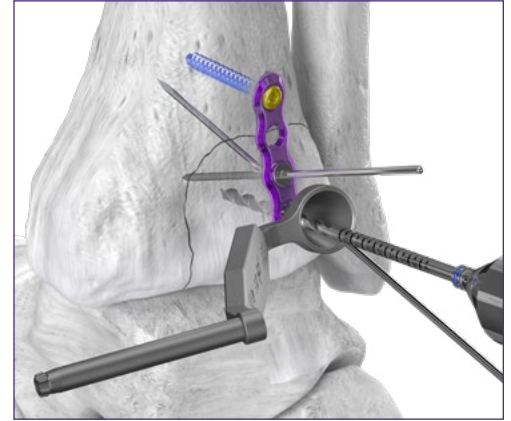
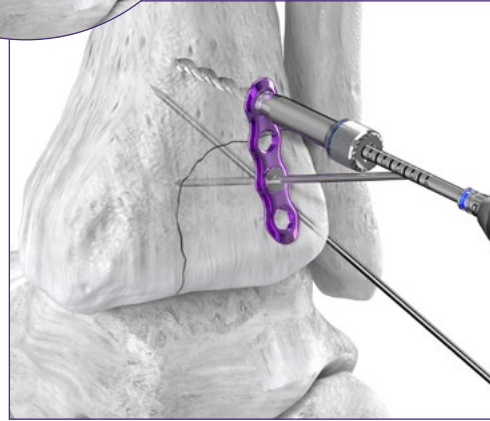
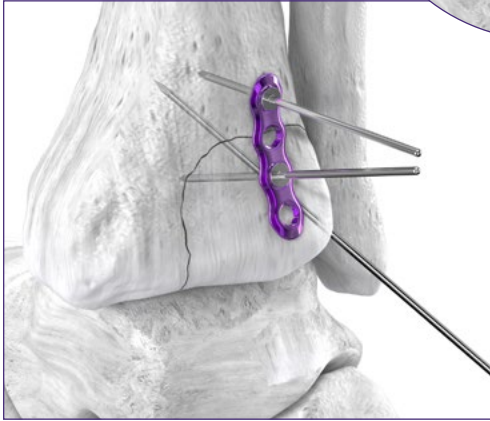

Select the 3 or 4 hole Trimalleolar Plate appropriate for the fracture type and size. Temporarily fix the plate to the posterior malleolus by placing 1-2 Olive Wires. Confirm plate placement using fluoroscopy.

All plate holes accept 2.7 mm, 3.5 mm or 4.2 mm locking or non-locking screws. Drill for the desired screw diameter in the proximal hole to anchor the plate proximally and allow the plate to assist in fracture reduction while placing the distal screws.

Depending on plate placement, the distal screw(s) may require off-axis drilling in a superior direction to avoid drill contact with the dome of the tibial plafond. The cone end of the Easy Cone Drill Guide can be used to limit drilling to 15° in any direction. Drill for the desired screw diameter.

Measure screw length using a depth gauge. Insert the selected screw into the drilled hole.

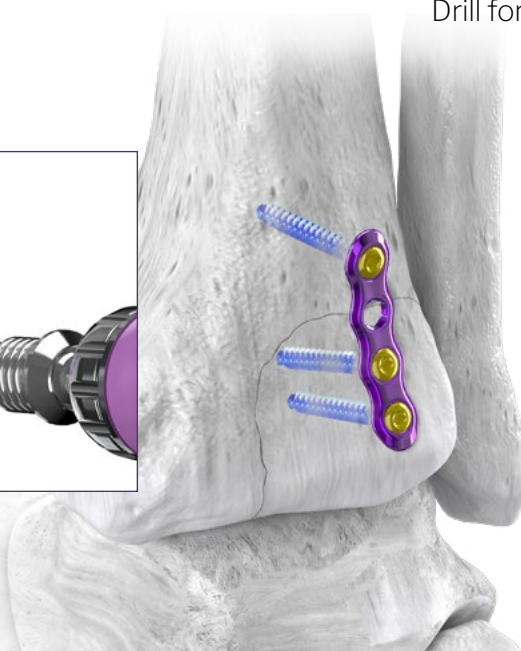
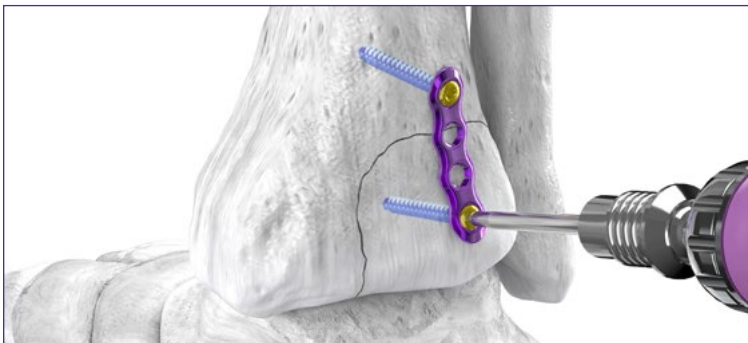

Repeat the steps above to fill the remaining screw holes. The same steps are used regardless if a locking or non-locking screw is used. Confirm plate and screw placement using fluoroscopy. Proceed to incision closure or adjunctive procedures at this time.

POSTEROLATERAL TIBIA PLATE

A posterolateral approach for use with the Posterolateral Tibia Plate is recommended. A posterolateral incision will require a lateral decubitus or prone patient position with the foot near the end of the table. Soft tissue dissection is carried down until the fracture site is visible.

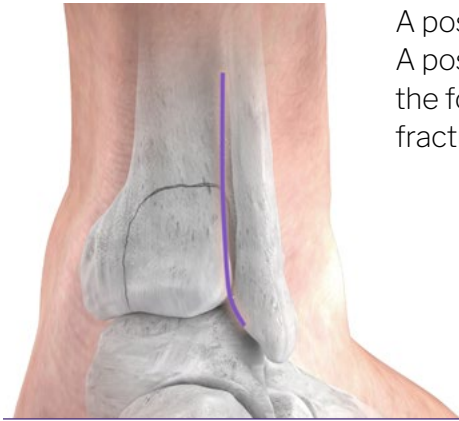

The fracture site is cleared and refreshed. Fracture reduction is performed and temporary stabilization is achieved using a K-wire or Tenaculum Clamp (shown), per surgeon preference.

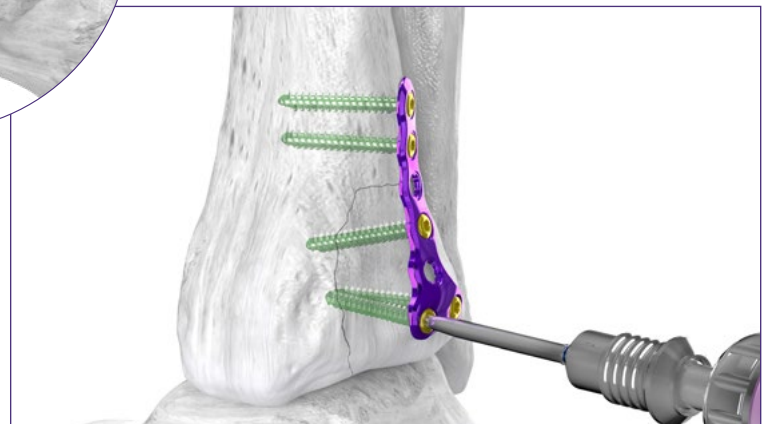

Select the appropriate Posterolateral Tibia Plate for fracture type and size. Temporarily fix the plate to the posterior malleolus by placing 1-2 Olive Wires. Confirm plate placement using fluoroscopy.

All plate holes accept 2.7 mm, 3.5 mm or 4.2 mm locking or non-locking screws. The distal two screw holes are tapped such that the screws, when placed on-axis, are directed superiorly away from the dome of the tibial plafond. If additional proximal angulation is desired, the cone end of the Easy Cone Drill Guide can be used during drilling.



NOTE:

If 4.2 mm screws are used in the two most distal screw holes (Holes 1 & 2), a short 4.2 mm screw (≤ 18 mm) must be used in the screw hole above it (Hole 3) to avoid screw collision; however, a full length 3.5mm (or smaller) screw diameter can be used.

If 3.5 mm screws or smaller are used in the three distal screw holes, there are no limits on screw lengths.

Hole 3

Holes 1 and 2

Upon placing all screws in the plate into desired screw holes, confirm screw position and lengths using fluoroscopy. Proceed to incision closure or adjunctive procedures at this time.

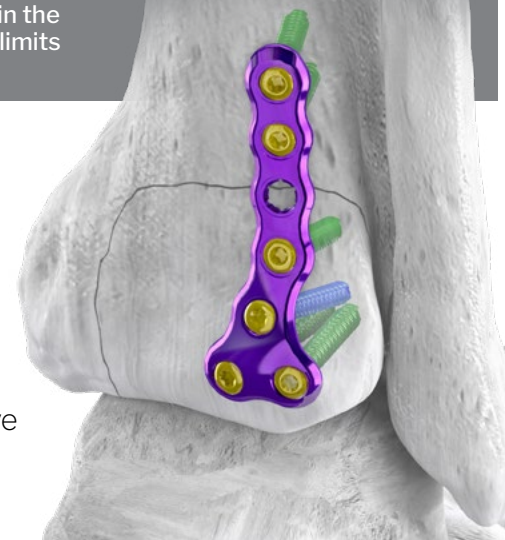

MEDIAL MALLEOLUS HOOK PLATE:

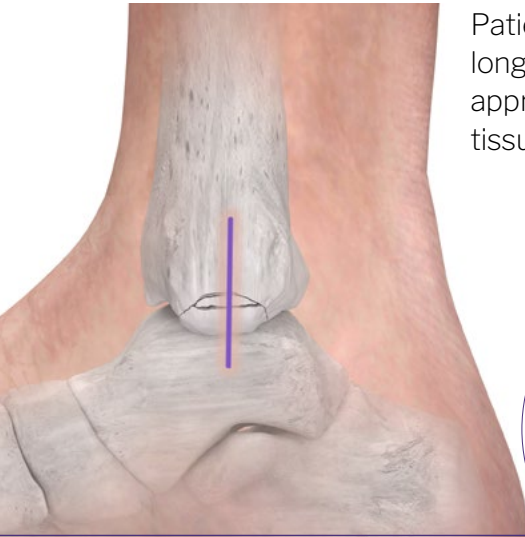

Patient is positioned supine such that the foot is near the end of the table. A longitudinal incision is made over the central aspect of the medial malleolus, appropriately sized for fracture access and anticipated plate length. Continue soft tissue dissection until the fracture site is visible.



The fracture site is cleared and refreshed. Fracture reduction is performed and temporary stabilization is achieved using a K-wire, reduction forcep or Lobster Claw clamp, per surgeon preference.

The Medial Hook Plate Drill Guide is available upon request when using the Medial Malleolus Hook Plate. The Hook Plate Drill Guide can be inserted by threading the threaded knob onto the template for positioning. Secure the template with an Olive Wire, if preferred.

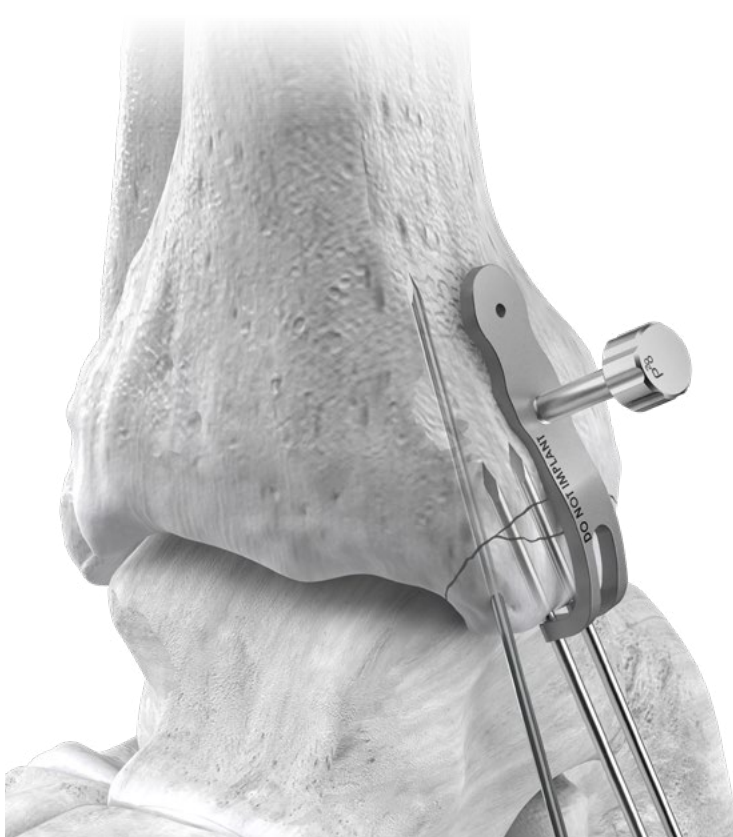
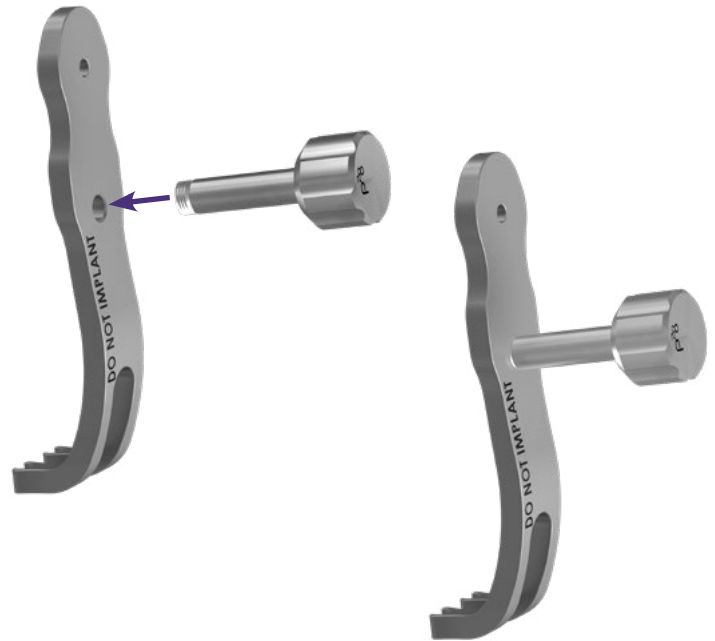

Using Ø2.0 mm K-wires, pre drill holes in the K-wire guides of the Hook Plate Drill Guide for the hook arms. Remove the Olive Wire of the template if necessary and slide off the Hook Plate Drill Guide. Remove the K-wires one at a time while replacing the first K-wire removed with the first hook. Removal of the second K-wire is performed while filling the second hole with the second hook.

MEDIAL MALLEOLUS HOOK PLATE:

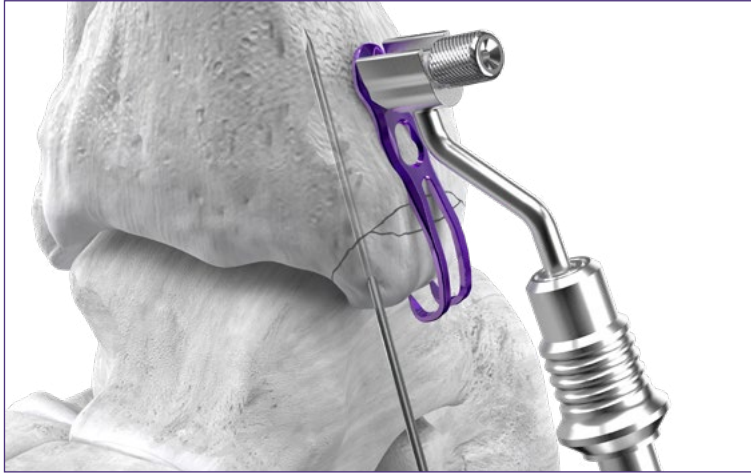

Select the appropriate Medial Malleolus Hook Plate for fracture type and size. Attach a Threaded Drill Tower to the hole adjacent the compression slot to assist with plate placement. Attach the Hook Plate Inserter to an AO Handle. Mate the Inserter with the neck of the Threaded Drill Tower to help position the hook plate. Press the plate onto bone, allowing the hooks to engage the distal tip of the medial malleolus.



NOTE:

If pre-drilling of the hooks is desired for a patient with a hard bone or for a severely comminuted fracture, 2.0 mm K-wires can be retrieved from the Gorilla Instrument Caddy to use for pre-drilling.



Insert a long Olive Wire into the Plate Positioning Tower to maintain plate position.

Alternatively, the Double Tamp or Single Tamp can be used to help engage the plate onto bone.

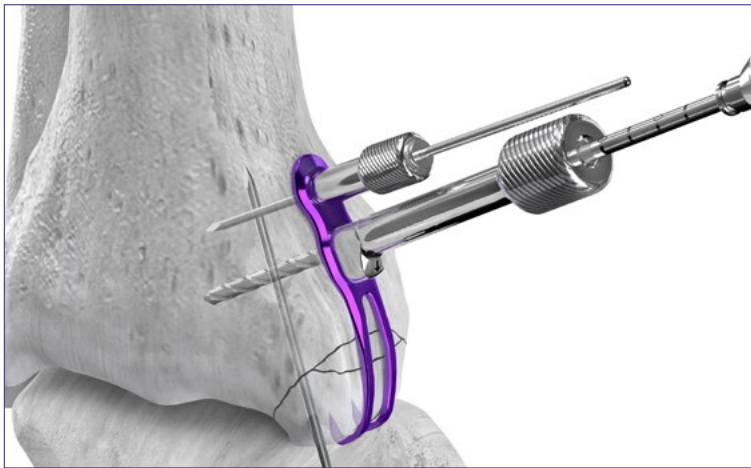

A compression drill guide is placed in the compression slot with the arrow pointing toward the fracture. Drill using the drill for desired screw diameter. The compression slot accepts 2.7 mm, 3.5 mm or 4.2 mm non-locking screws, while the remaining plate hole(s) accept locking or non-locking screws.

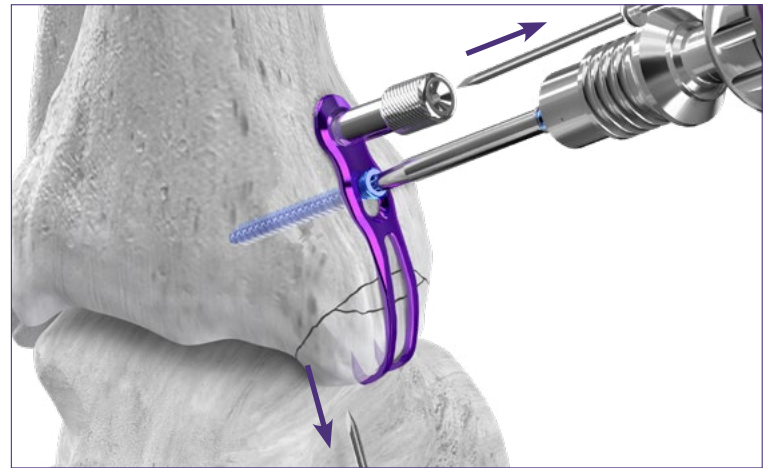

Measure screw length using a depth gauge. Insert the selected non-locking screw length into the plate hole. Prior to the screw head making contact with the plate, remove the long Olive Wire and the K-wire serving as temporary fixation. Fully seat the non-locking screw.

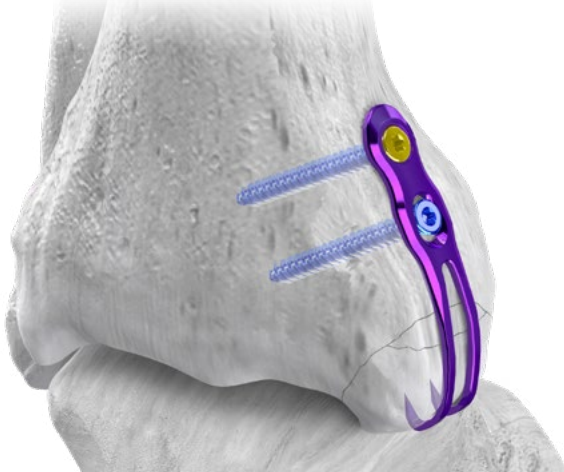

Fill the remaining plate screw hole(s) as desired. Confirm plate and screw placement using fluoroscopy. Proceed to incision closure or adjunctive procedures at this time.

STRAIGHT FIBULAR HOOK PLATE FEATURING: DOUBLE TAMP

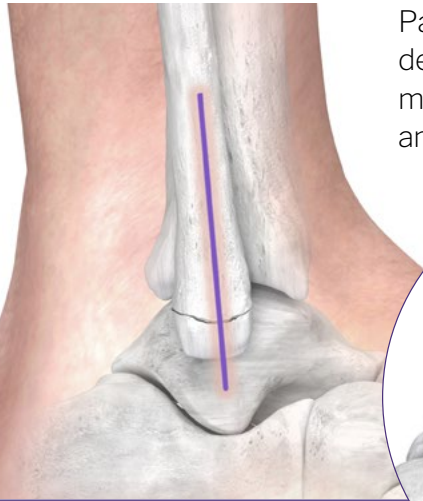

Patient is positioned supine such that the foot is near the end of the table, or in lateral decubitus, based on surgeon preference or fracture extent. A longitudinal incision is made over the central aspect of the fibula, appropriately sized for the fracture pattern and anticipated plate length.

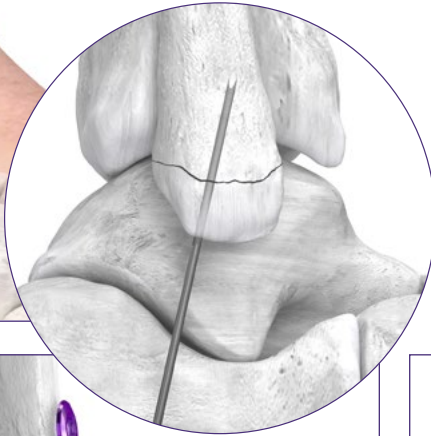

Continue soft tissue dissection until the fracture site is visible.

The fracture site is cleared and refreshed. Fracture reduction is performed and temporary stabilization is achieved using a K-wire, Pointed Reduction Forceps or Lobster Claw Clamp, per surgeon preference.

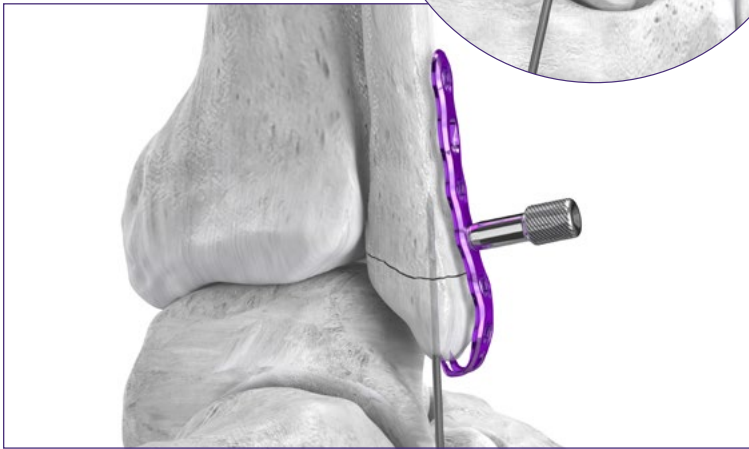

Select the appropriate Straight Fibular Hook Plate for fracture type and size. Attach a Plate Positioning Tower to the plate to assist with plate placement.

Place plate onto bone, allowing the hooks to engage the distal tip of the fibula. Retrieve the Double Tamp. Press the Double Tamp against the two hooks of the plate and tap the end with a mallet until the hooks have engaged the distal tip of the fibula.



NOTE:

If pre-drilling of the hooks is desired for a patient with hard bone or for a severely comminuted fracture, the Lateral Hook Plate Drill Guide is available upon request and can be used to pre-drill the hooks using the technique described on page 19 for the Medial Hook Plate Drill Guide.



Insert a long Olive Wire into the Plate Positioning Tower. A compression drill guide is placed in the compression slot with the arrow pointing toward the fracture.

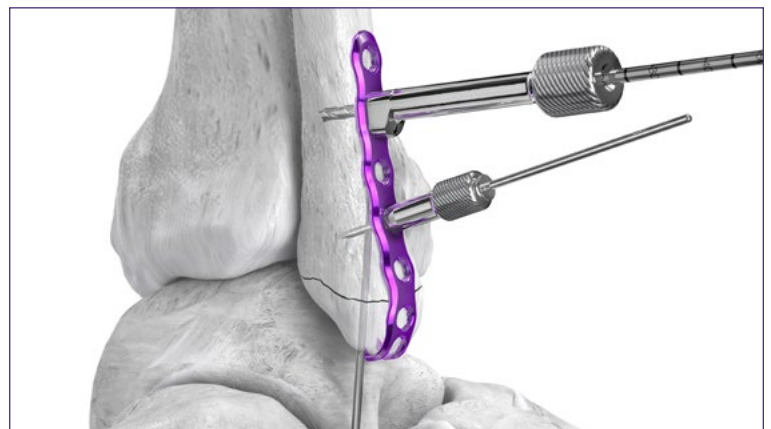

Drill using the drill for desired screw diameter. Measure screw length using a depth gauge.

STRAIGHT FIBULAR HOOK PLATE FEATURING: DOUBLE TAMP

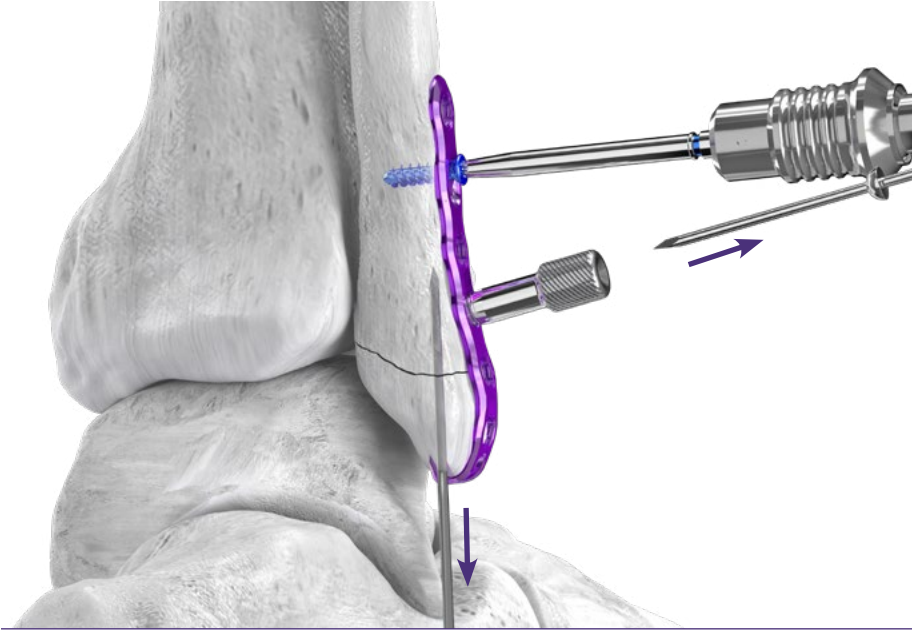

Insert the selected non-locking screw into the plate hole. Remove the long Olive Wire and the K-wire serving as temporary fixation prior to the screw head making contact with the plate.

While maintaining pressure on the hooks with the tamp, tighten and fully seat the compression screw in the compression slot once better hook position is achieved.



All remaining plate hole accept 2.7 mm, 3.5 mm or 4.2 mm locking or non-locking screws. Fill the remaining plate screw holes as desired. Confirm plate and screw placement using fluoroscopy. Proceed to incision closure or adjunctive procedures at this time.



NOTE:

If adequate compression of the fracture site is not achieved or if plate seating is not adequate with placement of the screw in the compression slot, back out the compression screw at least one quarter turn. Tamp the plate hooks using the Double Hook Tamp to seat the plate on the distal fibula.



Alternatively, the Single Tamp can be used per surgeon preference.

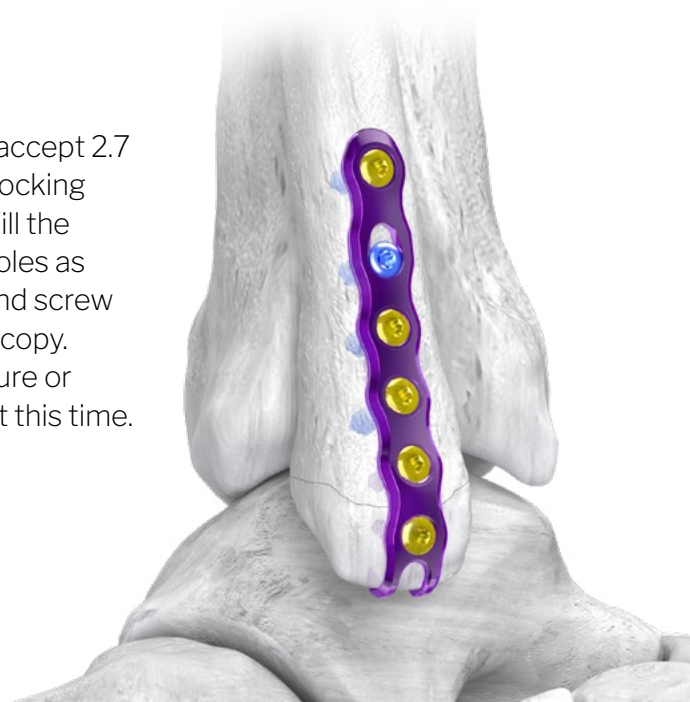

ANATOMIC FIBULAR HOOK PLATE FEATURING: HOOK SCREW DRILL GUIDE

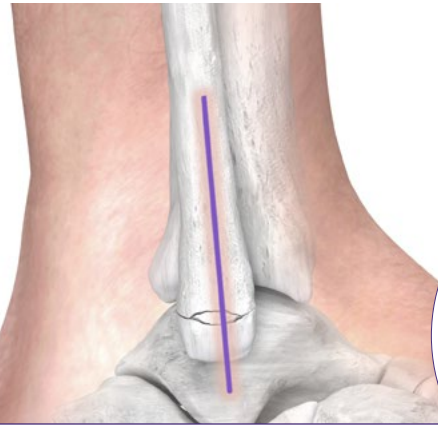

Patient is positioned supine such that the foot is near the end of the table, or in lateral decubitus, based on surgeon preference or fracture extent. A longitudinal incision is made over the central aspect of the fibula, appropriately sized for the fracture pattern and anticipated plate length. Continue soft tissue dissection until the fracture site is visible.

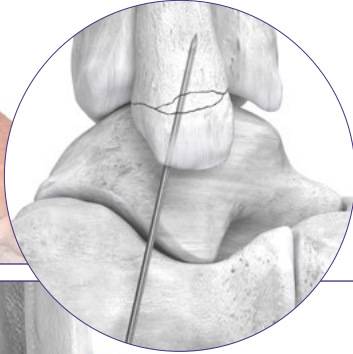

The fracture site is cleared and refreshed. Fracture reduction is performed and temporary stabilization is achieved using a K-wire, Pointed Reduction Forceps, or Lobster Claw Clamp, per surgeon preference.

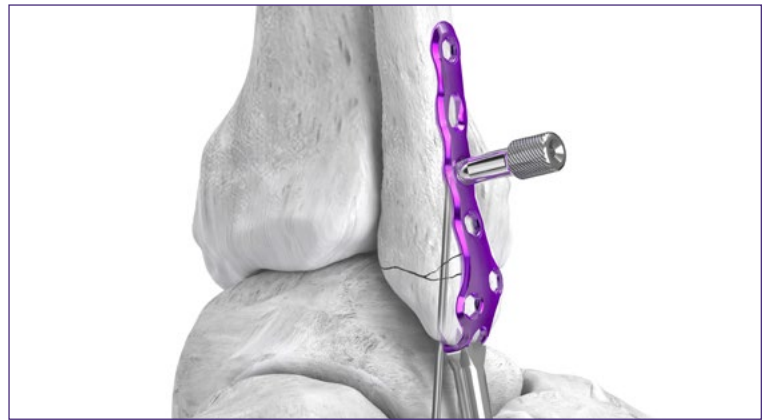

Select the appropriate Anatomic Fibular Hook Plate for fracture type and size. Attach a Plate Positioning Tower to the plate to assist with plate placement.

Place plate onto bone, allowing the hooks to engage with the distal tip of the fibula. Retrieve the double tamp. Press the double tamp against the two hooks of the straight plate and tap the end with a mallet until the hooks have engaged the distal tip of the fibula.



NOTE:

If pre-drilling of the hooks is desired for a patient with hard bone or for a severely comminuted fracture, the Lateral Hook Plate Drill Guide is available upon request and can be used to pre-drill the hooks using the technique described on page 19 for the Medial Hook Plate Drill Guide.



Insert a long Olive Wire into the Plate Positioning Tower. A compression drill guide is placed in the compression slot with the arrow pointing toward the fracture. Drill using the drill for desired screw diameter. Measure screw length using a depth gauge.



Insert the selected non-locking screw into the plate hole. Remove the long Olive Wire and the K-wire serving as temporary fixation prior to the screw head making contact with the plate.

ANATOMIC FIBULAR HOOK PLATE FEATURING: HOOK SCREW DRILL GUIDE

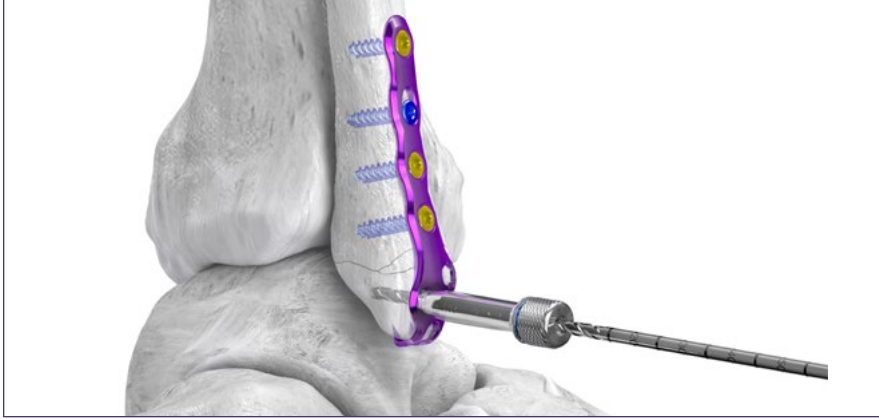

All remaining plate holes accept 2.7 mm, 3.5 mm or 4.2 mm locking or non-locking screws. Fill the remaining plate screw holes as desired. It is recommended to use the threaded drill guide and 3.5 mm or smaller screws when drilling for the distal two screws to avoid interference if a screw is used in between the hooks.

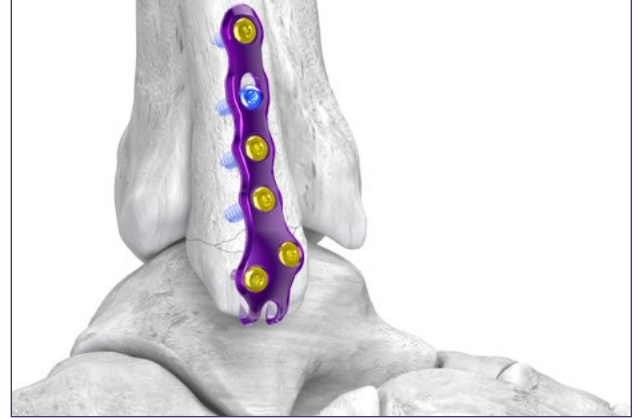

Confirm plate and screw placement using fluoroscopy, if desired.

OPTIONAL SCREW FIXATION



If screw placement between the hook screws is desired for fracture fragment fixation or additional stability of the fracture, retrieve the hook screw drill guide. Place the hook screw drill guide in between the hooks on the plate.



Drill through the hook screw drill guide using the drill for desired screw diameter. Measure for screw length using the depth gauge.



NOTE:

If a 4.2 mm hook screw is used, a 3.5 or smaller distal plate screw should be used to avoid screw interference.

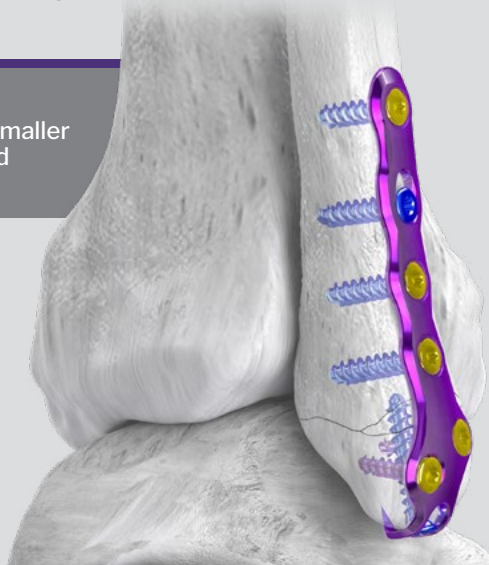

Insert the selected screw between the hooks. Check screw and plate position using fluoroscopy. Proceed to incision closure or adjunctive procedures at this time.

ANTERIOR DISTAL TIBIA PLATE



Pre-operative planning should be performed prior to the surgery, including evaluation of soft tissue condition, and review of radiographs and/or advanced imaging to determine approach and internal fixation needs. An anteromedial (shown), anterior or anterolateral approach to the distal tibia is recommended with supine patient positioning.

A posterolateral incision over the fibula is shown. Soft tissue dissection is performed until the fracture sites are visible. Execute fracture reduction per surgeon preference, achieving temporary stabilization of the tibia and fibula using available instruments and implants. Fibula fixation is performed per surgeon preference.

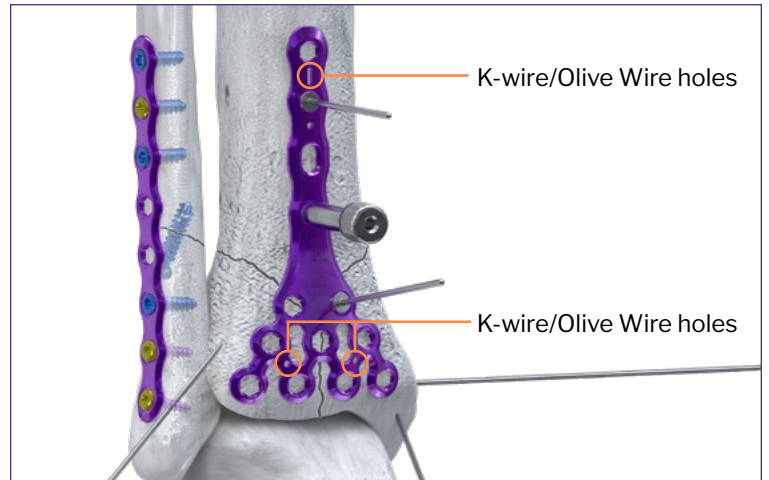
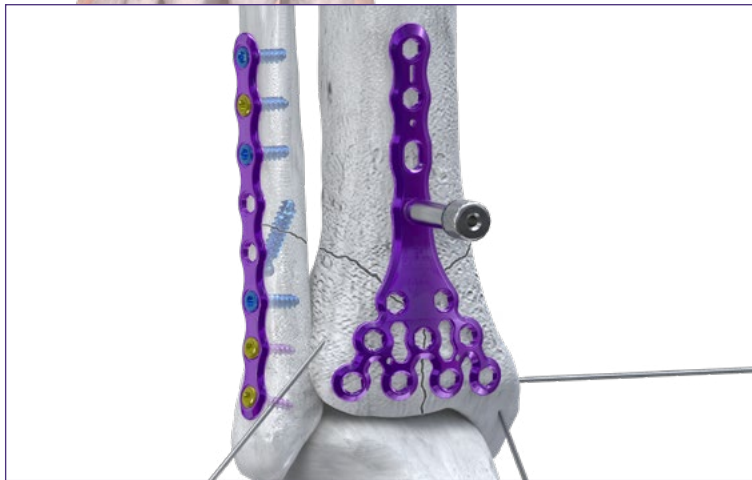

Retrieve the appropriate length Anterior Distal Tibia Plate. Place a threaded drill guide at the central aspect of the plate to facilitate plate insertion into the surgical site.

If provisional fixation of the plate to bone is preferred, Olive Wires are available to place within the screw holes or within the K-wire/Olive Wire holes in the plate. Confirm plate placement using fluoroscopy.

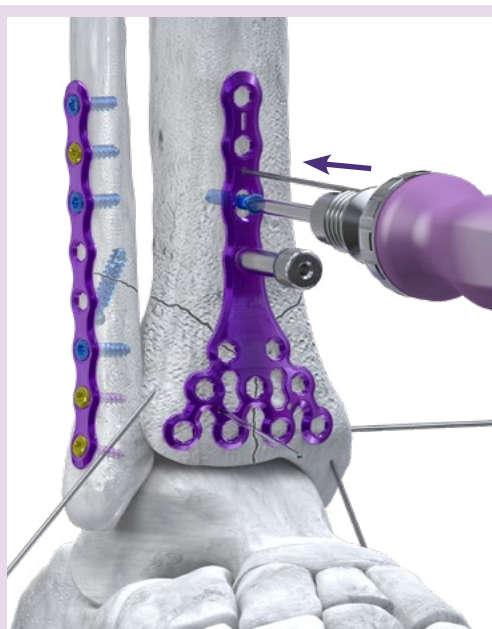
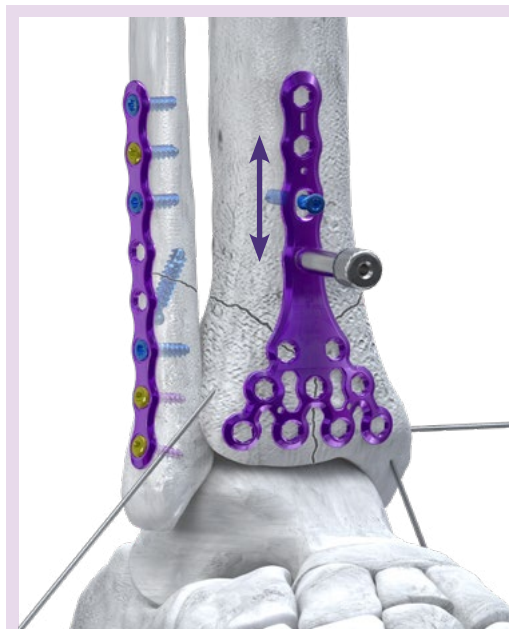

TIP:

The oblong slot on the Anterior Distal Tibia Plates is not a compression-ramped slot. For plates with an oblong slot, 2.7 mm, 3.5 mm or 4.2 mm non-locking screws can be placed centrally in the oblong slot once the plate is correctly positioned on the bone. Do not tighten down the non-locking screw completely. Using lateral fluoroscopy, adjust superior/inferior position, if necessary. Secure plate position by inserting K-wires in the K-wire/Olive Wire holes or placing screws in the circular holes, then tightening the non-locking screw.

ANTERIOR DISTAL TIBIA PLATE

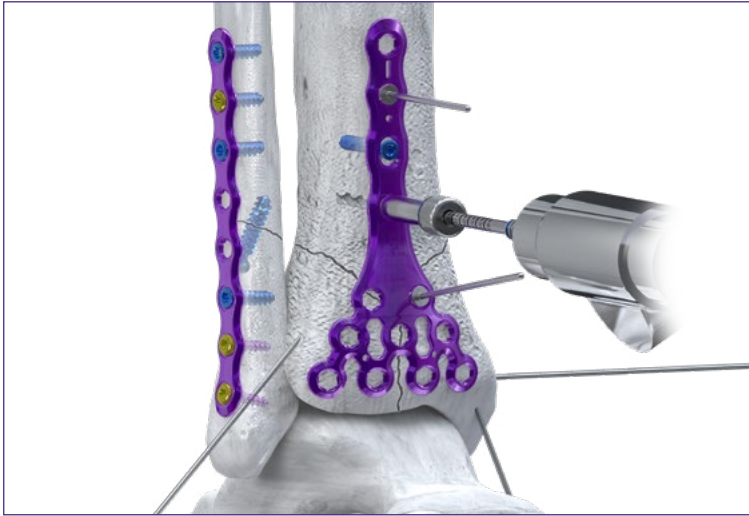

All circular plate holes accept 2.7 mm, 3.5 mm or 4.2 mm locking or non-locking screws, or 3.5 mm compact thread screws. Drill through the threaded drill tower using the drill sized for the desired screw diameter. Remove the threaded drill tower.

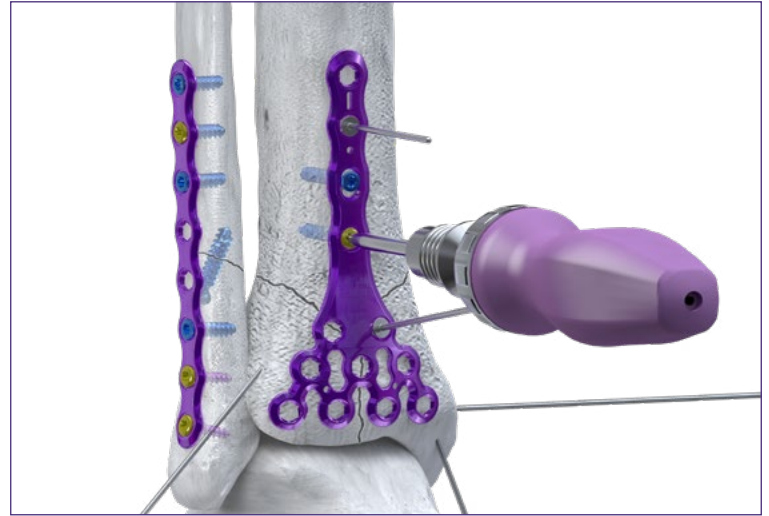

Measure screw length using a depth gauge. Insert the selected screw into the drilled hole in the tibia. Confirm screw position and length using fluoroscopy.

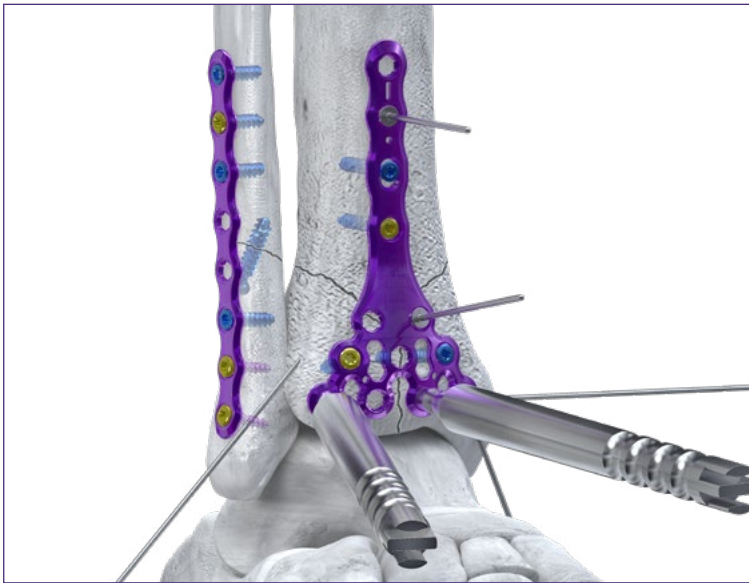

If plate bending is required after initial screw fixation, threaded plate benders are available to provide additional contouring.

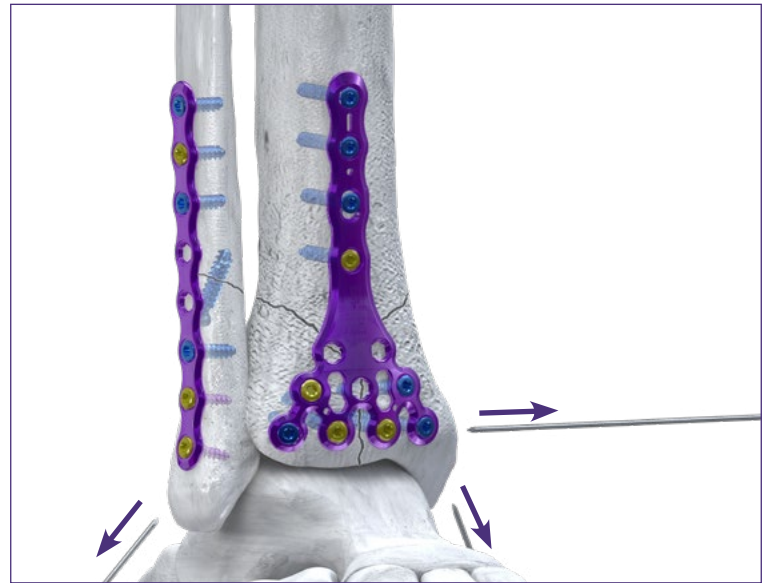

Continue placing locking or non-locking screws into necessary plate holes to properly stabilize the fracture. Remove Olive Wires or temporary stabilization wires when appropriate.



Confirm plate and screw placement using fluoroscopy

Proceed to incision closure or adjunctive procedures at this time.

ANTEROLATERAL AND MEDIAL DISTAL TIBIA PLATES



Pre-operative planning should be performed prior to the surgery, including evaluation of soft tissue condition, and review of radiographs and/or advanced imaging to determine approach and internal fixation needs. An anterolateral approach to the distal tibia is recommended when anterolateral plating is performed in combination with medial plating. A small medial incision is made distally for medial plate placement, with percutaneous incision(s) made for proximal screw fixation (not shown). Supine patient positioning is recommended.

Soft tissue dissection is performed until the fracture sites are visible. Execute fracture reduction per surgeon preference, achieving temporary stabilization of the tibia and fibula using available instruments and implants.

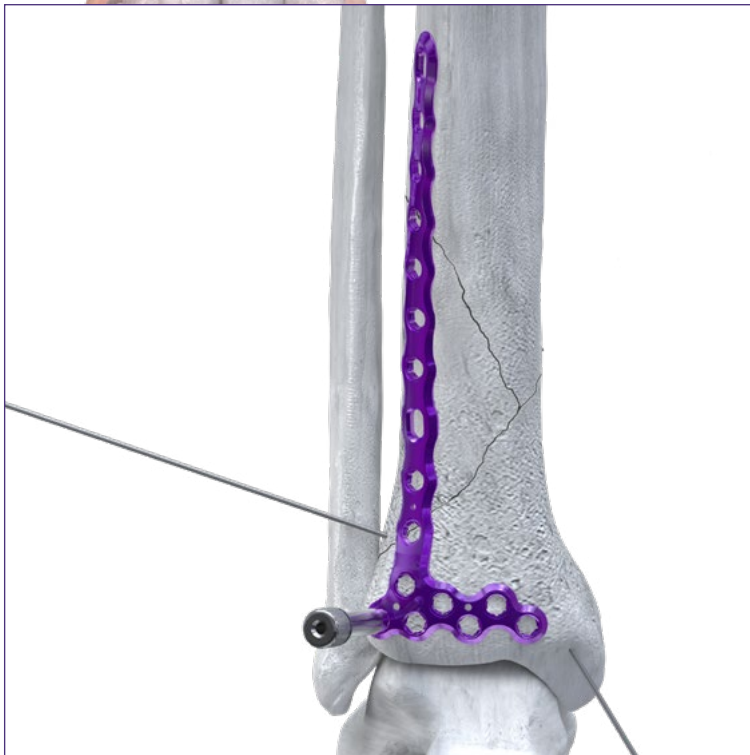

Retrieve the appropriate length Anterolateral Distal Tibia Plate. Use a Cobb or periosteal elevator to create a submuscular plane to allow for the entire length of the plate to be placed against the bone.

Place a threaded drill guide into one of the circular holes at the lateral aspect of the distal plate to facilitate plate insertion into the surgical site. Insert the proximal aspect of the plate into the incision site, sliding the plate superiorly to follow the submuscular plane that was created, until the distal aspect of the plate is appropriately positioned over the distal tibia. Confirm plate length and position using fluoroscopy.

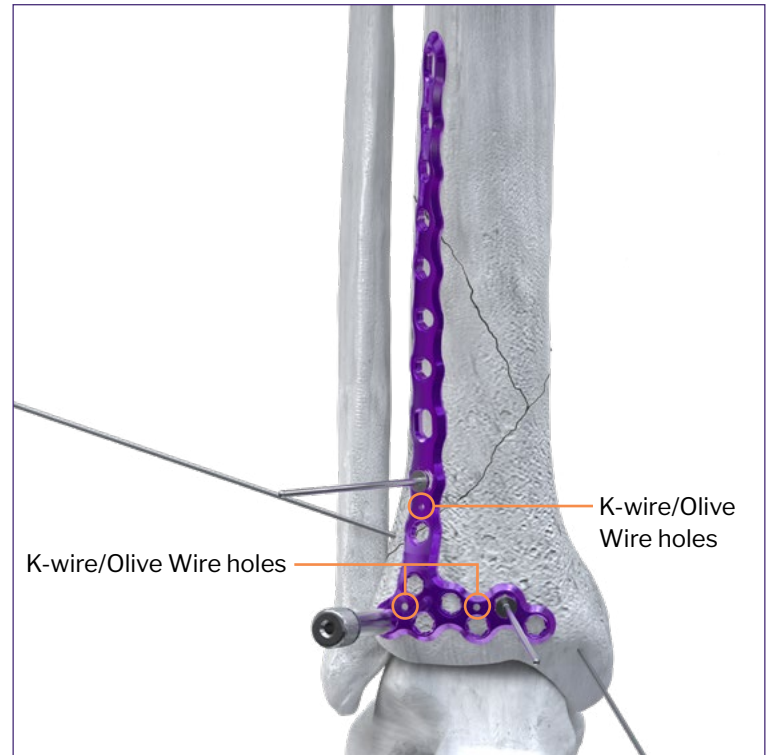

If provisional fixation of the plate to bone is preferred, Olive Wires are available to place within the screw holes or within the K-wire/Olive Wire holes in the plate. Confirm plate placement using fluoroscopy.

ANTEROLATERAL AND MEDIAL DISTAL TIBIA PLATES

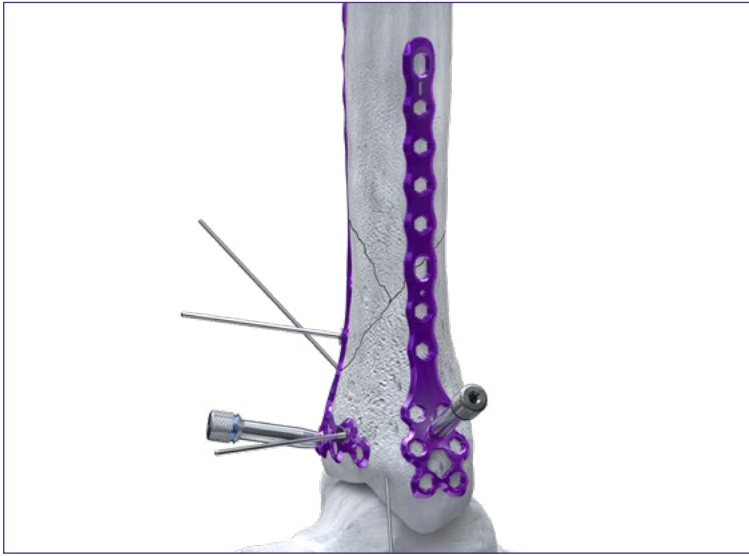

Retrieve the appropriate length Medial Distal Tibia Plate. Use a Cobb or periosteal elevator to create a submuscular plane to allow for the entire length of the plate to be placed against the bone.

Place a threaded drill guide into one of the circular holes in the distal cluster to facilitate insertion of the plate into the surgical site. Slide the proximal aspect of the plate into the incision site, sliding the plate superiorly to follow the submuscular plane that was created, until the distal aspect of the plate is appropriately positioned over the medial malleolus. Confirm plate length and position using fluoroscopy.

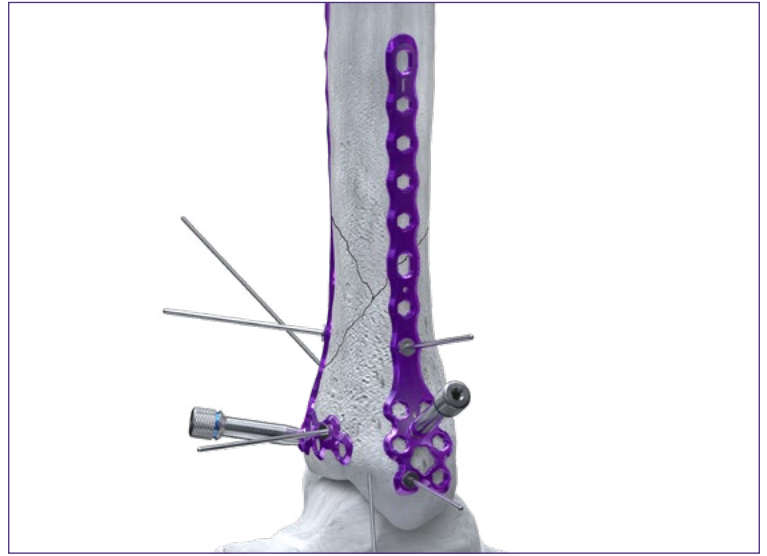

If provisional fixation of the plate to bone by the surgeon is preferred, temporary plate fixation can be performed as described previously for the anterolateral plate. All circular plate holes for the medial and anterolateral plates accept 2.7 mm, 3.5 mm, or 4.2 mm locking or non-locking screws. The oblong slot(s) on the medial and Anterolateral Distal Tibia Plates are not compression-ramped slots. The oblong slots accept 2.7 mm, 3.5 mm, or 4.2 mm non-locking screws.

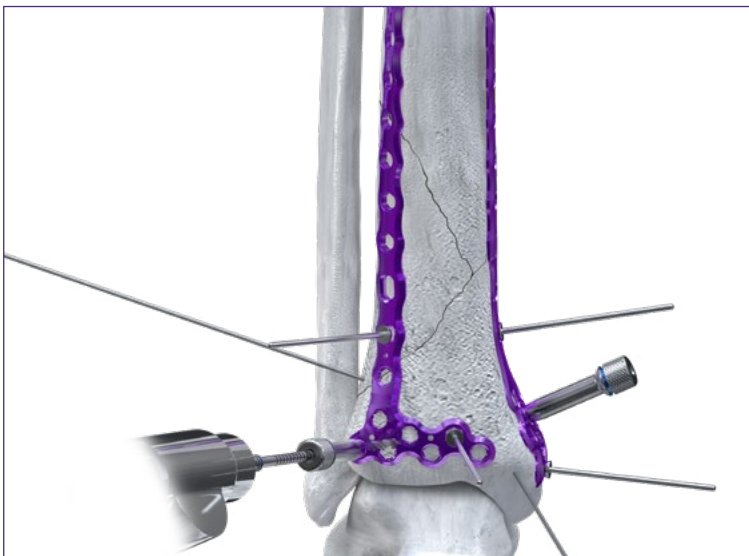

The order of screw placement is surgeon dependent and may vary with fracture pattern. To place screws, drill through the threaded drill tower (shown) or fast drill guide using the drill sized for the desired screw diameter.

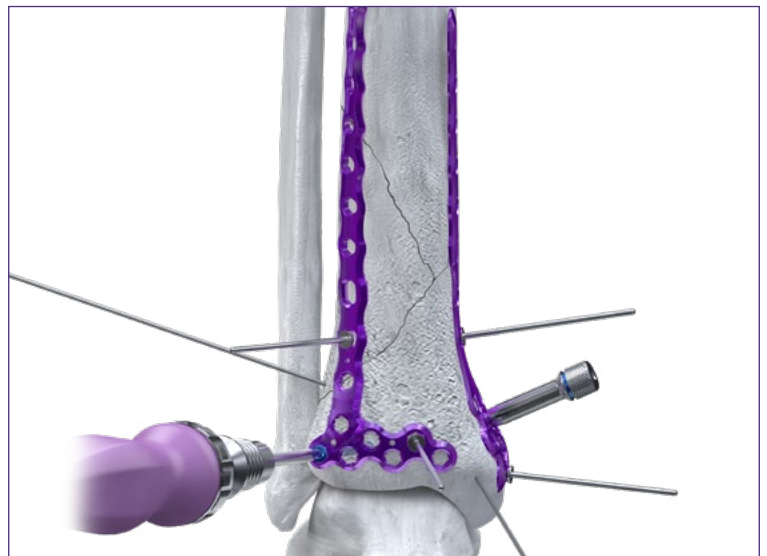

Remove the drill and threaded drill guide. Measure screw length using a depth gauge. Insert the selected screw into the drilled hole in the tibia. Confirm screw position and length using fluoroscopy.

ANTEROLATERAL AND MEDIAL DISTAL TIBIA PLATES

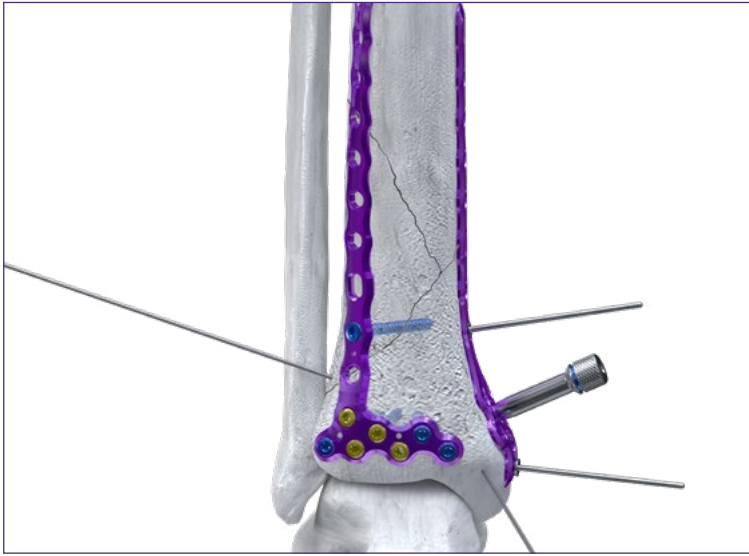

Repeat these steps for additional plate holes on the distal cluster of the anterolateral plate, removing Olive Wires once adequate plate fixation is achieved.



The order of screw placement in the medial plate is surgeon dependent and may vary with fracture pattern. To place screws in the Medial Distal Tibia Plate, drill through the threaded drill tower (shown) or fast drill guide using the drill sized for the desired screw diameter.



NOTE:

Screws in the distal cluster of the medial plate may be shorter in length to avoid collision with the anterolateral plate (if used), as well as avoiding the ankle joint space.

Remove the drill and threaded drill guide. Measure screw length using a depth gauge, ensuring that the screw will not violate the ankle joint. Insert the selected screw into the drilled hole in the tibia. Confirm screw position and length using fluoroscopy.

Repeat these steps for additional plate holes on the distal cluster of the anterolateral plate, removing Olive Wires once adequate plate fixation is achieved.

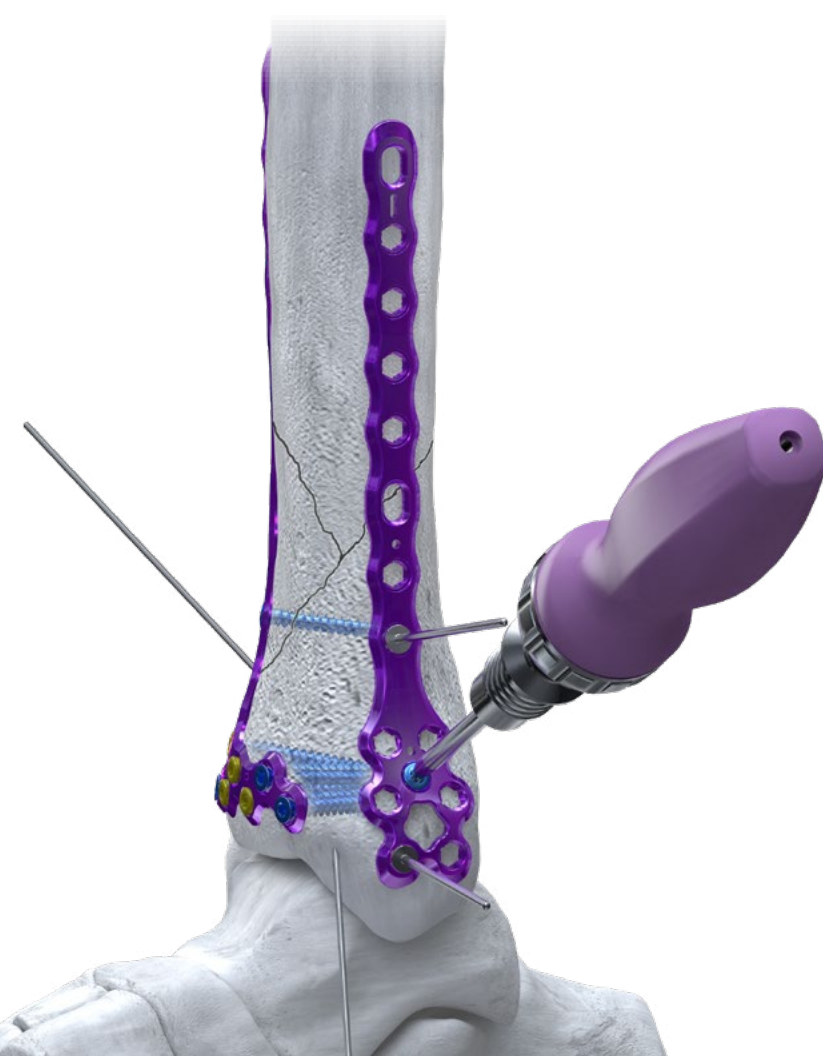

ANTEROLATERAL AND MEDIAL DISTAL TIBIA PLATES

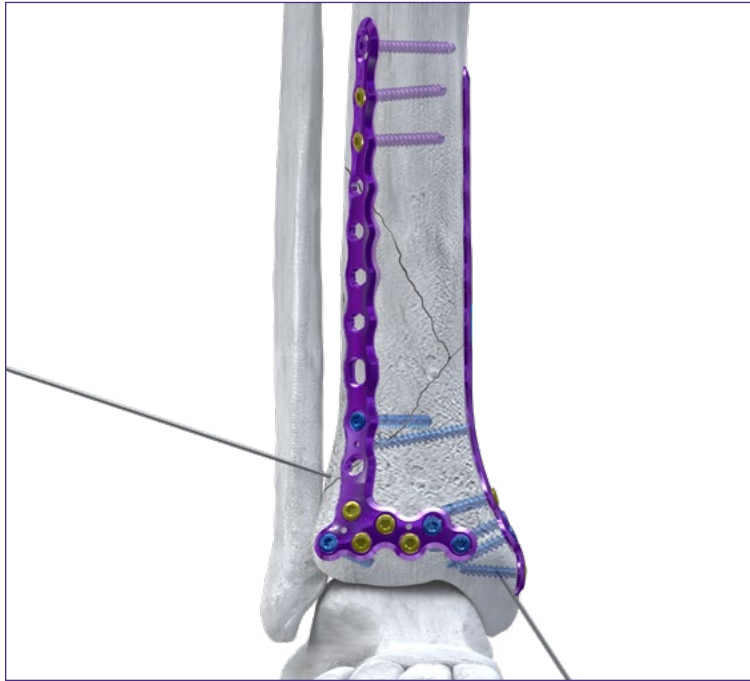
**NOTE:**

Creation of a proximal incision and proximal screw placement may take place earlier than shown, depending on surgeon preference.

An incision is made at the proximal aspect of the Anterolateral Distal Tibia Plate. Blunt soft tissue dissection is performed until the plate holes are visible. Place locking or non-locking screws into necessary plate holes, per fracture needs and surgeon preference. Per surgeon preference, Compact Screws help reduce insertion torque in dense bone and can be placed in the proximal tibia. These can be placed with the corresponding Pilot Drill, OverDrill or Tap.

**TIP:**

In instances of dense cortical bone, use the Ø3.5 mm Compact Screws.



A Percutaneous Depth Gauge is available to measure proximal tibial screws percutaneously.



An incision is made at the proximal aspect of the Medial Distal Tibia Plate. Blunt soft tissue dissection is performed until the plate holes are visible. Place locking or non locking screws as described above into necessary plate holes, per fracture needs and surgeon preference.

Temporary fixation of the fracture site may be removed when adequate stabilization of the fracture is achieved.

Once all plates and plate screws are placed, confirm screw lengths and proper reduction and fixation of the fracture fragments using fluoroscopy. Proceed to ancillary procedures or incision closure at this time.

GORILLA® CADDY AND CASE SYSTEM

1. GORILLA® ANKLE FRACTURE CADDY

The Gorilla® Ankle Fracture Plate Caddy contains the right and left Anatomic Fibular, Straight Fibular and the Medial Malleolus Plate options. The K-wire guide, threaded Plate Positioning Towers, Olive Wires and additional 3.5 mm R3CON locking and non-locking screws are also included in this caddy.



2. GORILLA® POSTERIOR AND HOOK PLATE CADDY

The Gorilla® Posterior and Hook Plate Caddy contains the right and left Anatomic Fibular, Straight Fibular and Medial Malleolus Hook Plates. Posterior Fibula, right and left Posterolateral Tibia, right and left. Posteromedial Tibia and Trimalleolar Fracture plate options are located in this caddy. Single and double hook tamps, the Hook Plate Screw Drill Guide, a bone hook, 1.6 mm x 8 cm Olive Wires and 1.6 mm x 10 cm Olive Wires are contained in this caddy.



3. GORILLA® DISTAL TIBIA PLATE CADDY

The Gorilla® Distal Tibia Plate Caddy contains the Anterior Distal Tibia, right and left Anterolateral Distal Tibia and the Medial Distal Tibia Plate options.

NOTE: The 16 Hole Medial Distal Tibia Plate and the right and left 16 hole and 18 hole Anterolateral Distal Tibia Plates are special order.



4. ANKLE FRACTURE 360™ SCREW CADDY

The Ankle Fracture 360™ Screw Caddy accommodates Ø2.7 mm, Ø3.5 mm and Ø4.2 mm R3CON Locking and Non-locking Screws. As well as Gorilla R3CON Ø3.5 mm Compact Locking and Non-locking screws and Ø4.0 mm Mini Monster Screws.

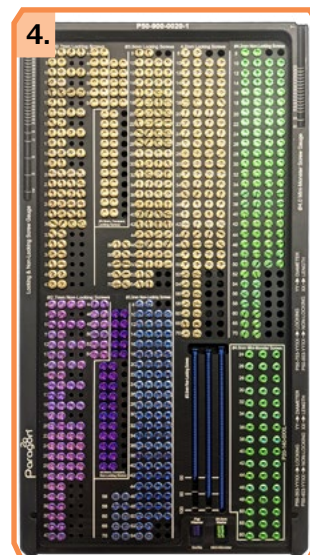

GORILLA® CADDY AND CASE SYSTEM

5. GORILLA® ANKLE FRACTURE 360™ INSTRUMENT TRAYS

Drills, drill guides, centering guides, taps, drivers, plate bending instrumentation, K-wires, olive wires, handles and Ø4.0 Mini Monster Instrumentation.

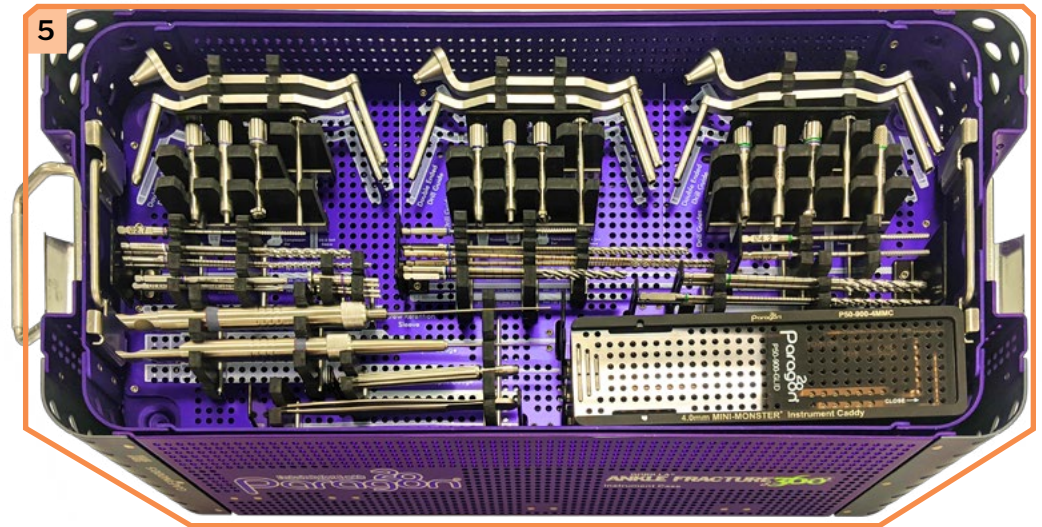

6. ADDITIONAL GORILLA® CADDIES

The Ankle Fracture 360™ Implant Case has room for additional Gorilla® Plate Caddies or PRESERVE™ Allograft caddies that may be needed for additional procedures performed in addition to an Ankle Fracture.



7. ANKLE FRACTURE 360™ INSTRUMENT CASE

Reduction clamps, joint preparation instrumentation and retractors are located at the bottom of the Ankle Fracture 360 Instrument Case Base.

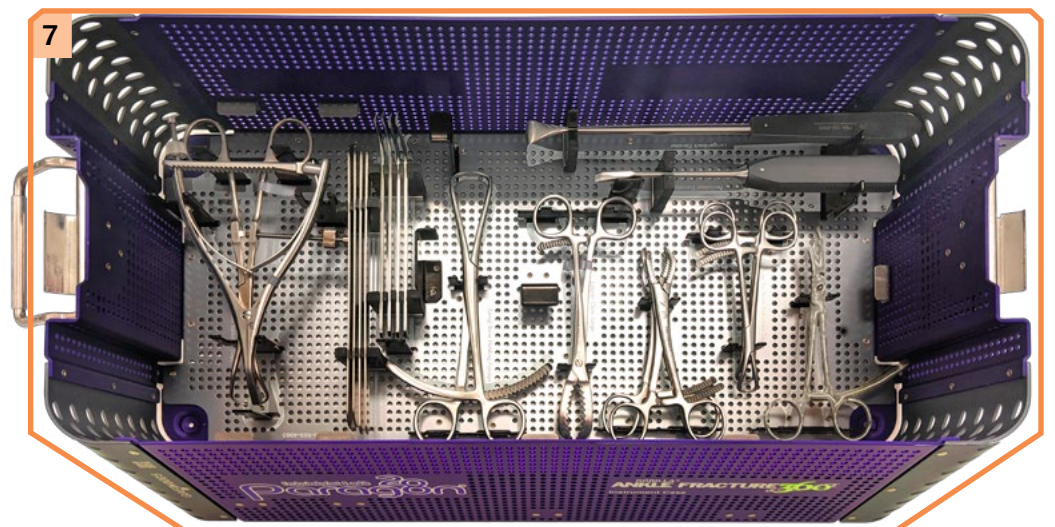

Refer to www.paragon28.com/ifus for the complete and most current instructions for use document.

INDICATIONS FOR USE (GORILLA®)

The Baby Gorilla®/Gorilla® Bone Plates and Bone Screws of the Baby Gorilla®/Gorilla® Plating System are indicated for use in stabilization and fixation of fractures or osteotomies; intra and extra articular fractures, joint depression, and multi-fragmentary fractures; revision procedures, joint fusion and reconstruction of small bones of the toes, feet and ankles including the distal tibia, talus, and calcaneus, as well as the fingers, hands, and wrists. The system can be used in both adult and pediatric patients. Specific examples include:

Forefoot:

- Arthrodesis of the first metatarsalcuneiform joint (Lapidus Fusion)
- Metatarsal or phalangeal fractures and osteotomies
- Lesser metatarsal shortening osteotomies (e.g. Weil)
- Fifth metatarsal fractures (e.g. Jones Fracture)

Mid/Hindfoot:

- LisFranc Arthrodesis and/or Stabilization
- 1st (Lapidus), 2nd, 3rd, 4th, and 5th Tarsometatarsal (TMT) Fusions
- Intercuneiform Fusions
- Navicular-Cuneiform (NC) Fusion
- Talo-Navicular (TN) Fusion
- Calcaneo-Cuboid (CC) Fusion
- Subtalar Fusion
- Medial Column Fusion
- Cuneiform Fracture
- Cuboid Fracture
- Navicular Fracture

Ankle:

- Lateral Malleolar Fractures
- Syndesmosis Injuries
- Medial Malleolar Fractures and Osteotomies
- Bi-Malleolar Fractures
- Tri-Malleolar Fractures
- Posterior Malleolar Fractures
- Distal Anterior Tibia Fractures
- Vertical Shear Fractures of the Medial Malleolus
- Pilon Fractures
- Distal Tibia Shaft Fractures
- Distal Fibula Shaft Fractures
- Distal Tibia Periarticular Fractures
- Medial Malleolar Avulsion Fractures
- Lateral Malleolar Avulsion Fractures
- Tibiotalocalcaneal Joint Arthrodesis
- Tibiotalar Joint Arthrodesis
- Tibiocalcaneal Arthrodesis
- Supramalleolar Osteotomy
- Fibular Osteotomy

First metatarsal osteotomies for hallux valgus correction including:

- Opening base wedge osteotomy
- Closing base wedge osteotomy
- Crescentic Osteotomy
- Proximal Osteotomy (Chevron and Rotational Oblique)
- Distal Osteotomy (Chevron/Austin)

Arthrodesis of the first metatarsophalangeal joint (MTP)

including:

- Primary MTP Fusion due to hallux rigidus and/or hallux valgus
- Revision MTP Fusion
- Revision of failed first MTP Arthroplasty implant

Flatfoot:

- Lateral Column Lengthening (Evans Osteotomy)
- Plantar Flexion Opening Wedge Osteotomy of the Medial Cuneiform (Cotton Osteotomy)
- Calcaneal Slide Osteotomy

Charcot:

- Medial column fusion (talus, navicular, cuneiform, metatarsal) for neuropathic osteoarthropathy (Charcot)
- Lateral column fusion (calcaneus, cuboid, metatarsal) for neuropathic osteoarthropathy (Charcot)

In addition, the non-locking, titanium screws and washers are indicated for use in bone reconstruction, osteotomy, arthrodesis, joint fusion, fracture repair and fracture fixation, appropriate for the size of the device.

CONTRAINDICATIONS

Use of the Baby Gorilla®/Gorilla® Plating System is contraindicated in cases of inflammation, cases of active or suspected sepsis/infection and osteomyelitis; or in patients with certain metabolic diseases.

All applications that are not defined by the indications are contraindicated. In addition, surgical success can be adversely affected by:

- Acute or chronic infections, local or systemic
- Vascular, muscular or neurological pathologies that compromise the concerned extremity
- All concomitant pathologies that could affect the function of the implant
- Osteopathies with reduced bone substance that could affect the function of the implant
- Any mental or neuromuscular disorder that could result in an unacceptable risk of failure at the time of fixation or complications in post-operative treatment
- Known or suspected sensitivity to metal
- Corpulence; an overweight or corpulent patient can strain the implant to such a degree that stabilization or implant failure can occur
- Whenever the use of the implant comes into conflict with the anatomical structures of physiological status

Other medical or surgical pre-conditions that could compromise the potentially beneficial procedure, such as:

- The presence of tumors
- Congenital abnormalities
- Immunosuppressive pathologies
- Increased sedimentation rates that cannot be explained by other pathologies
- Increased leukocyte (WBC) count
 - Pronounced left shift in the differential leukocyte count

Refer to www.paragon28.com/ifus for the complete and most current instructions for use document.

POTENTIAL COMPLICATIONS AND ADVERSE REACTIONS

In any surgical procedure, the potential for complications and adverse reactions exist. The risks and complications with these implants include:

- Loosening, deformation or fracture of the implant
- Acute post-operative wound infections and late infections with possible sepsis
- Migration, subluxation of the implant with resulting reduction in range of movement
- Fractures resulting from unilateral joint loading
- Thrombosis and embolism
- Wound hematoma and delayed wound healing
- Temporary and protracted functional neurological perturbation
- Tissue reactions as the result of allergy or foreign body reaction to dislodged particles
- Corrosion with localized tissue reaction and pain
- Pain, a feeling of malaise or abnormal sensations due to the implant used
- Bone loss due to stress shielding

All possible complications listed here are not typical of Paragon 28®, Inc. products but are in principle observed with any implant. Promptly inform Paragon 28®, Inc. as soon as complications occur in connection with the implants or surgical instruments used. In the event of premature failure of an implant in which a causal relationship with its geometry, surface quality or mechanical stability is suspected, please provide Paragon 28®, Inc. with the explant(s) in a cleaned, disinfected and sterile condition. Paragon 28®, Inc. cannot accept any other returns of used implants. The surgeon is held liable for complications

INDICATIONS FOR USE (MONSTER®)

The Monster® Screw System is indicated for use in bone reconstruction, osteotomy, arthrodesis, joint fusion, ligament fixation, fracture repair and fracture fixation, appropriate for the size of the device. Specific examples include:

Fractures and Osteotomies

- Fractures of the tarsals, metatarsals and other fractures of the foot (i.e. LisFranc)
- Avulsion fractures and fractures of the 5th metatarsal (i.e. Jones Fracture)
- Talar fractures
- Ankle fractures
- Navicular fractures
- Fractures of the fibula, malleolus, and calcaneus
- Metatarsal and phalangeal osteotomies
- Weil osteotomy
- Calcaneal osteotomy

Hallux Valgus Correction

- Fixation of osteotomies (i.e. Akin, Scarf, Chevron)
- Interphalangeal (IP) arthrodesis
- Proximal, midshaft, or distal osteotomy
- Lapidus arthrodesis

associated with inadequate asepsis, inadequate preparation of the osseous implant bed in the case of implants, incorrect indication or surgical technique or incorrect patient information and consequent incorrect patient behavior.

WARNINGS AND PRECAUTIONS

- Re-operation to remove or replace implants may be required at any time due to medical reasons or device failure. If corrective action is not taken, complications may occur.
- Use of an undersized plate or screw in areas of high functional stresses may lead to implant fracture and failure.
- Plates and screws, wires, or other appliances of dissimilar metals should not be used together in or near the implant site.
- The implants and guide wires are intended for single use only.
- Instruments, guide wires and screws are to be treated as sharps.
- Do not use other manufacturer's instruments or implants in conjunction with the Baby Gorilla®/Gorilla® Plating System.
- If a stainless steel Gorilla® R3LEASE™ Screw is used, it may only be used standalone.
- The device should only be used in pediatric patients where the growth plates have fused or in which active growth plates will not be crossed by the system implants or instrumentation.

MR SAFETY INFORMATION

The Baby Gorilla®/Gorilla® Plating System has not been evaluated for safety and compatibility in the MR environment. It has not been tested for heating, migration, or image artifact in the MR environment. The safety of Baby Gorilla®/Gorilla® Plating System in the MR environment is unknown. Scanning a patient who has this device may result in patient injury.

Arthrodesis/Deformity Correction

- 1st MTP arthrodesis
- Metatarsal deformity correction
- Tarsometatarsal joint arthrodesis
- Naviculocuneiform joint arthrodesis
- Talonavicular arthrodesis
- Subtalar joint arthrodesis
- Triple arthrodesis
- Medial column arthrodesis
- Subtalar joint distraction arthrodesis
- Ankle arthrodesis
- Lateralizing calcaneal osteotomy
- Lateral column lengthening
- Hammertoe

Fusion resulting from neuropathic osteoarthopathy (Charcot) such as:

- Medial and lateral column
- Subtalar, talonavicular, and calcaneocuboid

CONTRAINDICATIONS

Use of the Monster® Screw System is contraindicated in cases of inflammation, cases of active or suspected sepsis / infection and osteomyelitis; or in patients with certain metabolic diseases.

Refer to www.paragon28.com/ifus for the complete and most current instructions for use document.

CONTRAINDICATIONS (CONTINUED)

All applications that are not defined by the indications are contraindicated. In addition, surgical success can be adversely affected by:

- Acute or chronic infections, local or systemic
- Vascular, muscular or neurological pathologies that compromise the concerned extremity
- All concomitant pathologies that could affect the function of the implant
- Osteopathies with reduced bone substance that could affect the function of the implant
- Any mental or neuromuscular disorder that could result in an unacceptable risk of failure at the time of fixation or complications in post-operative treatment
- Known or suspected sensitivity to metal
- Corpulence; an overweight or corpulent patient can strain the implant to such a degree that stabilization or implant failure can occur
- Whenever the use of the implant comes into conflict with the anatomical structures of physiological status

Other medical or surgical pre-conditions that could compromise the potentially beneficial procedure, such as:

- The presence of tumors
- Congenital abnormalities
- Immunosuppressive pathologies
- Increased sedimentation rates that cannot be explained by other pathologies
- Increased leukocyte (WBC) count
- Pronounced left shift in the differential leukocyte count

POTENTIAL COMPLICATIONS AND ADVERSE REACTIONS

In any surgical procedure, the potential for complications and adverse reactions exist. The risks and complications with these implants include:

- Loosening, deformation or fracture of the implant
- Acute post-operative wound infections and late infections with possible sepsis
- Migration, subluxation of the implant with resulting reduction in range of movement
- Fractures resulting from unilateral joint loading
- Thrombosis and embolism
- Wound hematoma and delayed wound healing
- Temporary and protracted functional neurological perturbation
- Tissue reactions as the result of allergy or foreign body reaction to dislodged particles.
- Corrosion with localized tissue reaction and pain
- Pain, a feeling of malaise or abnormal sensations due to the implant used
- Bone loss due to stress shielding

All possible complications listed here are not typical of Paragon 28®, Inc. products but are in principle observed with any implant. Promptly inform Paragon 28® as soon as complications occur in connection with the implants or surgical instruments used. In the event of premature failure of an implant in which a causal relationship with its geometry, surface quality or mechanical stability is suspected, please provide Paragon 28® with the explant(s) in a cleaned, disinfected and sterile condition. Paragon 28® cannot accept any other returns of used implants. The surgeon is held liable for complications associated with inadequate asepsis, inadequate preparation of the osseous implant bed in the case of implants, incorrect indication or surgical technique or incorrect patient information and consequent incorrect patient behavior.

WARNINGS AND PRECAUTIONS

- Re-operation to remove or replace implants may be required at any time due to medical reasons or device failure. If corrective action is not taken, complications may occur.
- Use of an undersized screw in areas of high functional stresses may lead to implant fracture and failure.
- Plates and screws, wires, or other appliances of dissimilar metals should not be used together in or near the implant site.
- The implants and guide wires are intended for single use only. Re-use may cause product failure and could lead to disease transmission.
- Instruments, guide wires and screws are to be treated as sharps.
- Do not use other manufacturer's instruments or implants in conjunction with the Monster® Screw System.

MR SAFETY INFORMATION

The Monster® Screw System has not been evaluated for safety and compatibility in the MR environment. It has not been tested for heating, migration, or image artifact in the MR environment. The safety of the Monster® Screw System in the MR environment is unknown. Scanning a patient who has this device may result in patient injury.

GORILLA® ANKLE FRACTURE 360™

PATENTED, DESIGNED & EXCLUSIVELY DISTRIBUTED BY

Exclusively foot & ankle
Paragon 28®

P51-STG-0008 RevF [2021-07-26]

™Trademarks and ®Registered Marks of Paragon 28®, Inc.
© Copyright 2021 Paragon 28®, Inc. All rights reserved.
Patents: www.paragon28.com/patents

Paragon 28, Inc. 
14445 Grasslands Dr.
Englewood, CO 80112 USA
(855) 786-2828

DISCLAIMER

The purpose of the Gorilla® Ankle Fracture Surgical Technique Guide is to demonstrate the optionality and functionality of the Ankle Fracture Plating System implants and instrumentation in the Gorilla® R3CON Plating System. Although various methods can be employed for these procedures, the fixation options demonstrated were chosen for simplicity of explanation and demonstration of the unique features of our device. Federal law (U.S.A.) restricts this device to sale and use by, or on order of, a physician.