

PHANTOM

ACTIVCORE™ NAIL SYSTEM

SURGICAL TECHNIQUE GUIDE
Tibiotalocalcaneal Arthrodesis



CONTENTS

SECTION 1	PHANTOM ACTIVCORE™ NAIL SYSTEM
	PHANTOM® SYSTEM ADVANTAGES 4
	PHANTOM ACTIVCORE™ NAIL FEATURES5-6
	ACTIVCORE NAIL – HOW IT WORKS7-8
	PRECISION® GUIDE FEATURES 9
	GHOST™ OUTRIGGER FEATURES.....10
	PHANTOM ACTIVCORE™ NAIL SYSTEM IMPLANTS 11
	JOINT PREPARATION INSTRUMENTATION 12
	INSTRUMENTATION 13
SECTION 2	TTC ARTHRODESIS USING THE PHANTOM ACTIVCORE™ NAIL
	PATIENT POSITIONING 14
	INCISION/EXPOSURE - TIBIOTALAR AND SUBTALAR JOINTS 14
	TIBIOTALAR AND SUBTALAR JOINT POSITIONING AND TEMPORARY FIXATION 14
	IMPLANT SIZING..... 15
	ESTABLISH ENTRY POINT INCISION AND DRILL-PIN INSERTION 16
	USE OF THE PRECISION GUIDE FOR DRILL-PIN PLACEMENT 16-18
	ALTERNATIVE: FREEHAND DRILL-PIN INSERTION 18
	OPTIONAL: USE OF THE PARALLEL OFFSET GUIDE 18

SECTION 2 (CONTINUED)	TTC ARTHRODESIS USING THE PHANTOM ACTIVCORE™ NAIL
	ENTRY DRILLING19
	STEPPED REAMING19
	FLEXIBLE REAMING20
	NAIL ASSEMBLY 21-22
	ALIGNMENT CHECK23-24
	NAIL INSERTION 25-27
	CALCANEAL THREADED PEG INSERTION28-30
	TIBIAL THREADED PEG INSERTION..... 31-32
	REMOVING THE TENSION SCREW32
	OUTRIGGER REMOVAL33
	END CAP PLACEMENT.....33
	CLOSURE.....33
	IMPLANT REMOVAL34
	CASES35
SECTION 3	INDICATIONS, CONTRAINDICATIONS, AND WARNINGS
	PHANTOM ACTIVCORE™ NAIL SYSTEM INDICATIONS, CONTRAINDICATIONS, AND WARNINGS.....36

PHANTOM® SYSTEM ADVANTAGES

- Allows for constant, postoperative, non-weight bearing compression to accommodate up to 8 mm of bone resorption across the joints
- Weight-bearing compression achieved through patient gait
- Flex Coil Tip allows for stress-sharing within the tibia¹
- PRECISION® Guide Technology allows for precise and reproducible placement of the initial Drill-Pin to determine implant trajectory
- Ø7.2 mm Headless, Fully Threaded Pegs, in the calcaneus for increased fixation
- Variable (0° - 18°) posterior-anterior Calcaneal Threaded Peg trajectory allows for precise placement and optimized purchase
- Distal end of the Nail is Ø13.3 mm through the subtalar and tibiotalar joints
- Robust offering of joint preparation instrumentation for a tibiotalar and tibiotalocalcaneal arthrodesis

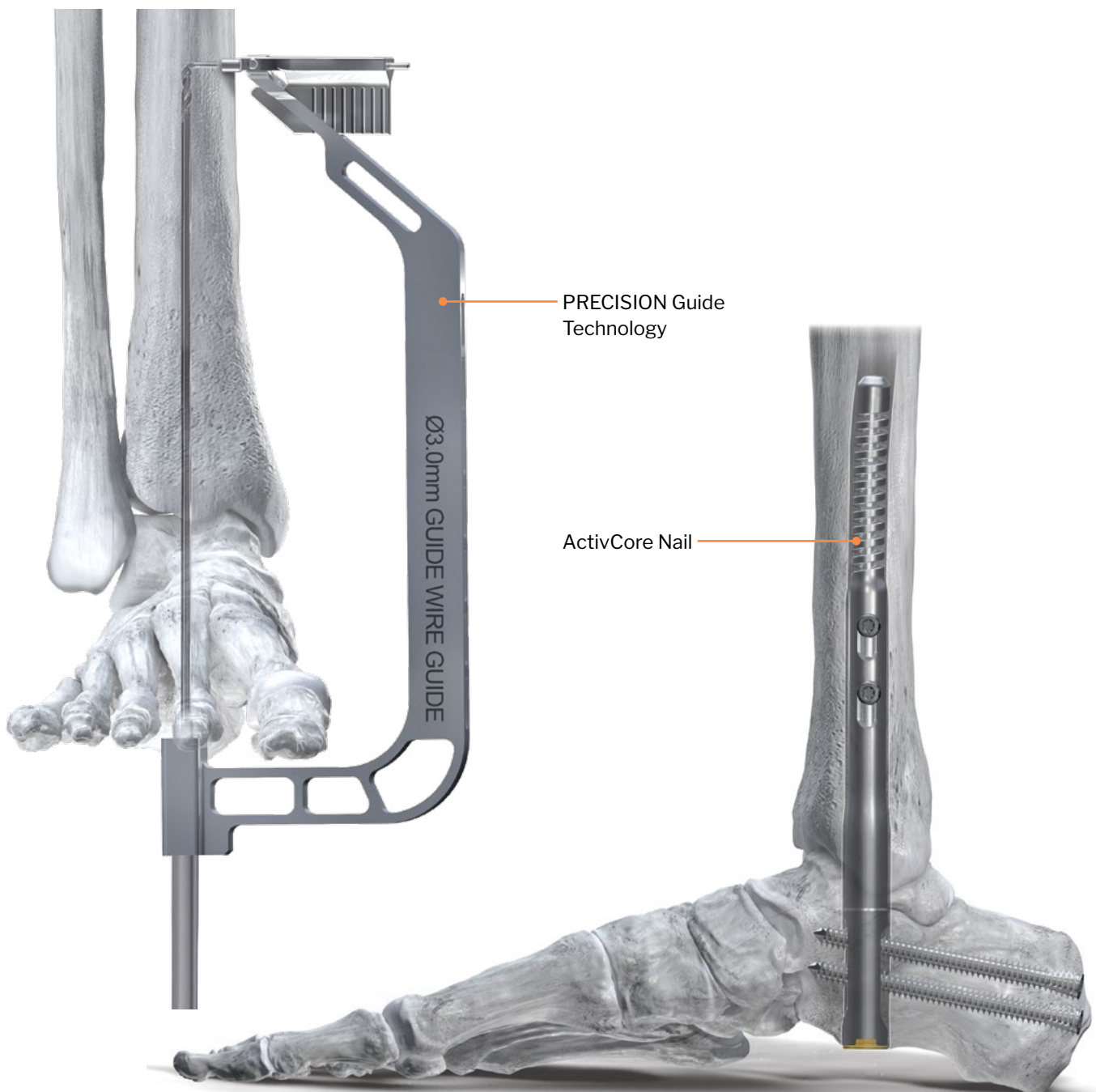

PHANTOM ACTIVCORE™ NAIL FEATURES

- Up to 8 mm of constant, internal, non-weight bearing compression across the tibiotalar and subtalar joints
- Acclimates to bone resorption across the joints, promoting bone healing
- Flex Coil Tip allows for stress sharing within the tibia¹
- Constructed from Type II Anodized Titanium Alloy which has been shown to have increased fatigue strength²
- 250 mm and 300 mm length Nails feature a 3rd guided proximal Tibial Threaded Peg

3rd proximal Tibial Threaded Peg
250 mm and 300 mm Nail lengths

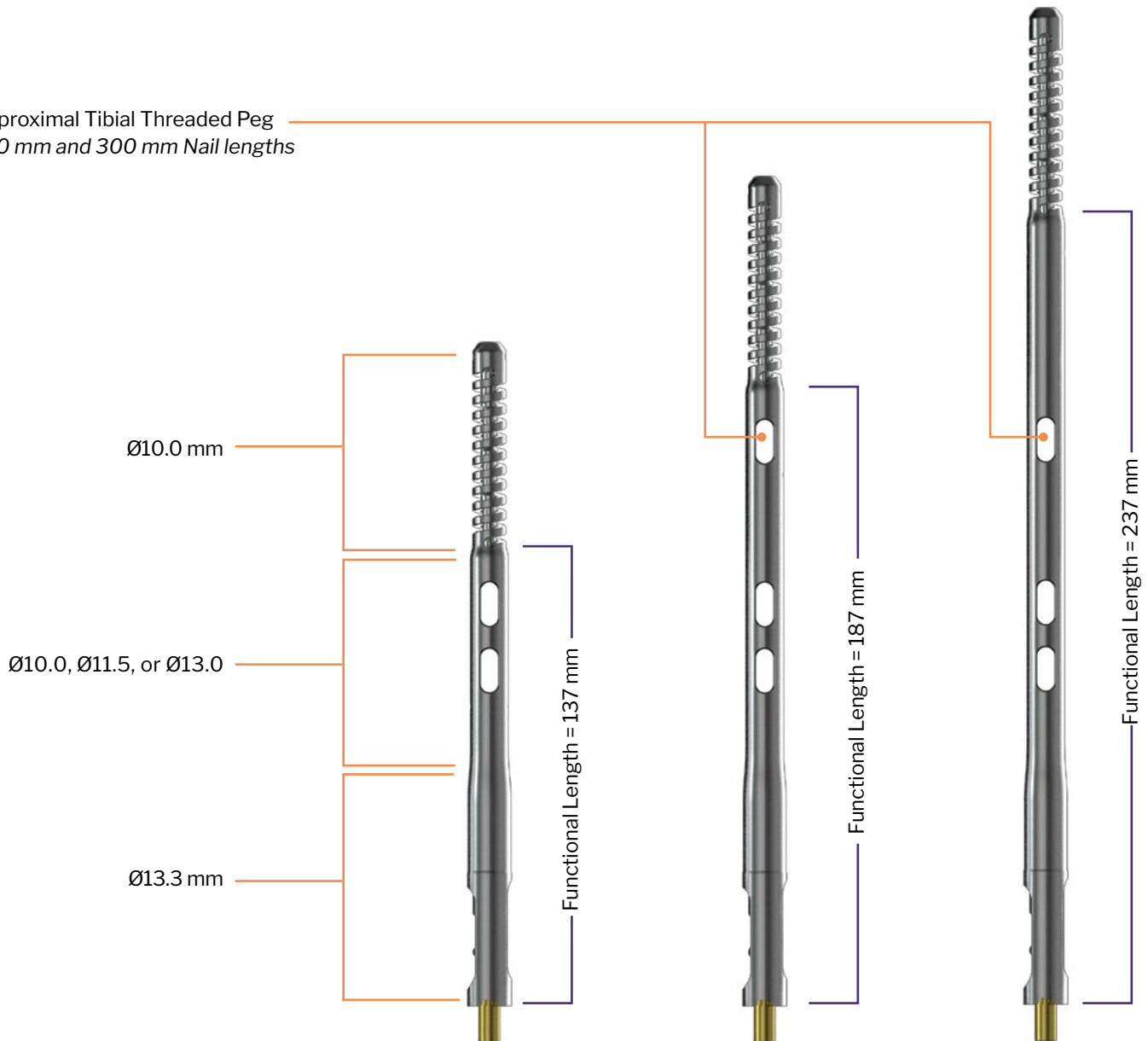

		LENGTH OPTIONS		
		200 mm	250 mm	300 mm
FUNCTIONAL LENGTH		137 mm	187 mm	237 mm
DIAMETER OPTIONS	Ø10.0 mm	●	●	●
	Ø11.5 mm	●	●	●
	Ø13.0 mm	●	●	

PHANTOM ACTIVCORE™ NAIL FEATURES

POSTERIOR VIEW

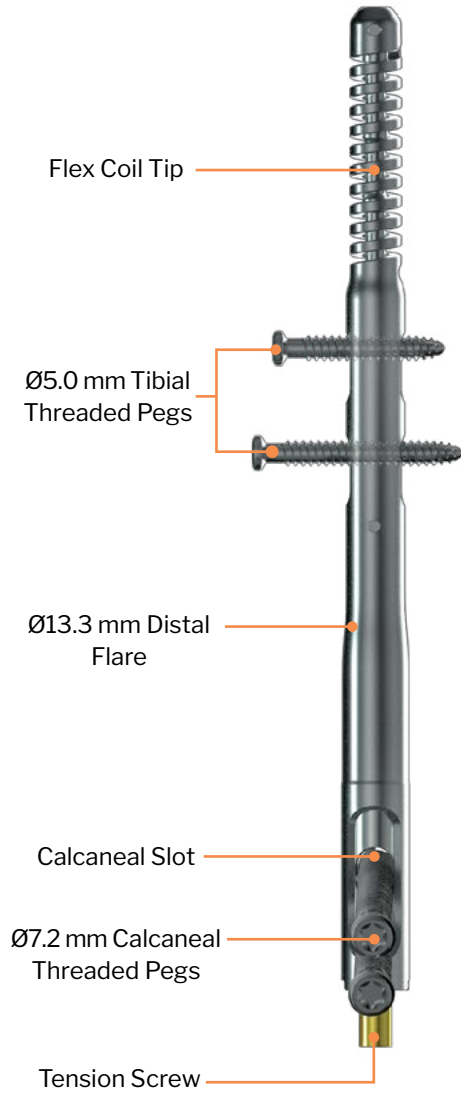

MEDIAL VIEW

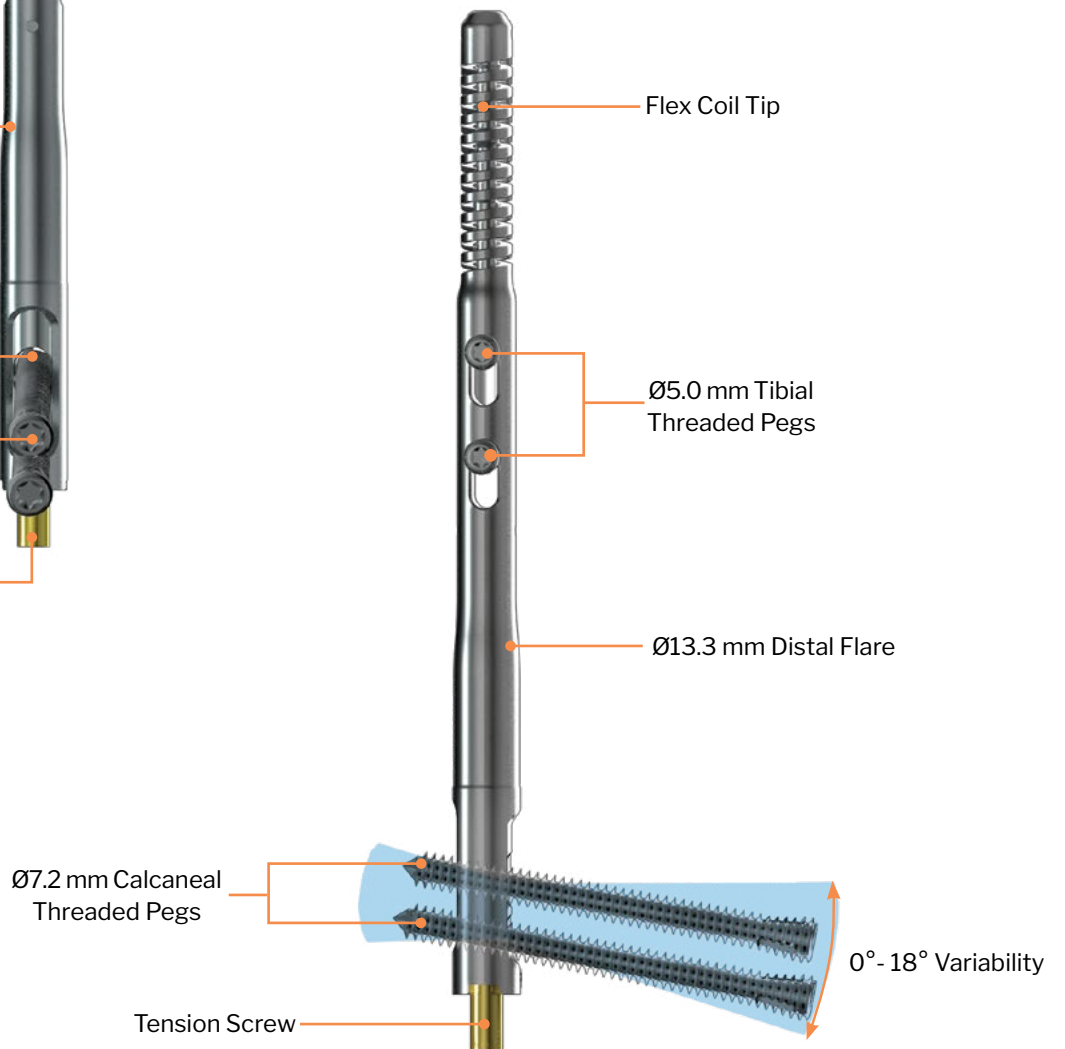

ACTIVCORE NAIL – HOW IT WORKS

PRE-LOADED STATE

RELEASED STATE CONSTANT JOINT COMPRESSION

RELEASED STATE DURING WEIGHT-BEARING CONSTANT JOINT COMPRESSION

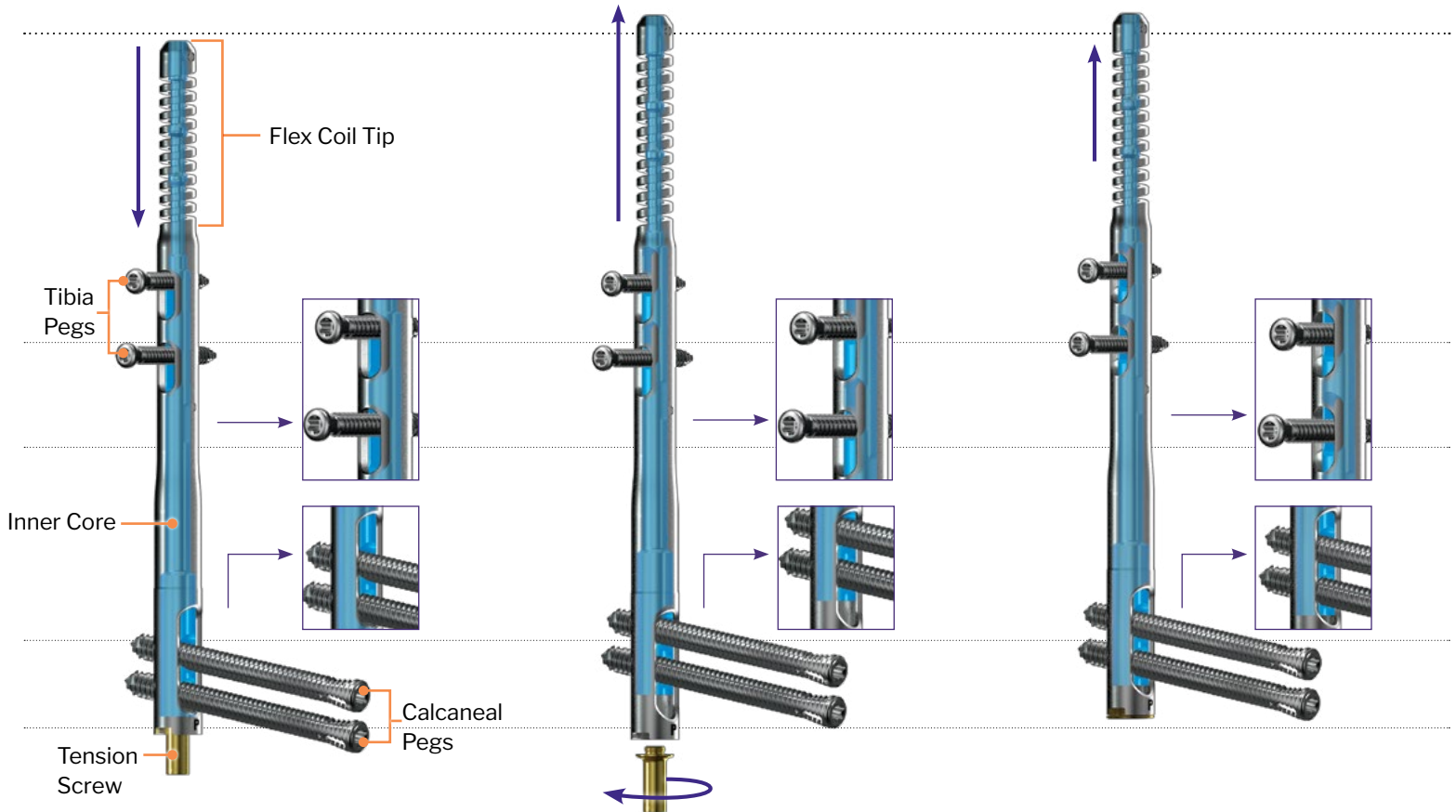

PRE-LOADED STATE

- Tension Screw is pre-loaded distally in the Nail
- Inner core is pulled down
- Ø5.0 mm Pegs are placed proximally in tibial Nail slots
- Ø7.2 mm Pegs are placed distally in calcaneal Nail slots

RELEASED STATE CONSTANT JOINT COMPRESSION

- Tension Screw is released
- Flex Coil expands translating inner core proximally
- 420 newtons of compression applied across the subtalar and tibiotalar joints³
- Up to 8 mm of constant compression as Nail acclimates to bone resorption*

RELEASED STATE DURING WEIGHT-BEARING CONSTANT JOINT COMPRESSION

- During weight-bearing, the tibial pegs stay in place and the entire Nail construct translates proximally
- Compression is maintained across the tibiotalar and subtalar joints during weight-bearing and throughout gait

ACTIVCORE NAIL - HOW IT WORKS

PRE-LOADED STATE

RELEASED STATE CONSTANT JOINT COMPRESSION

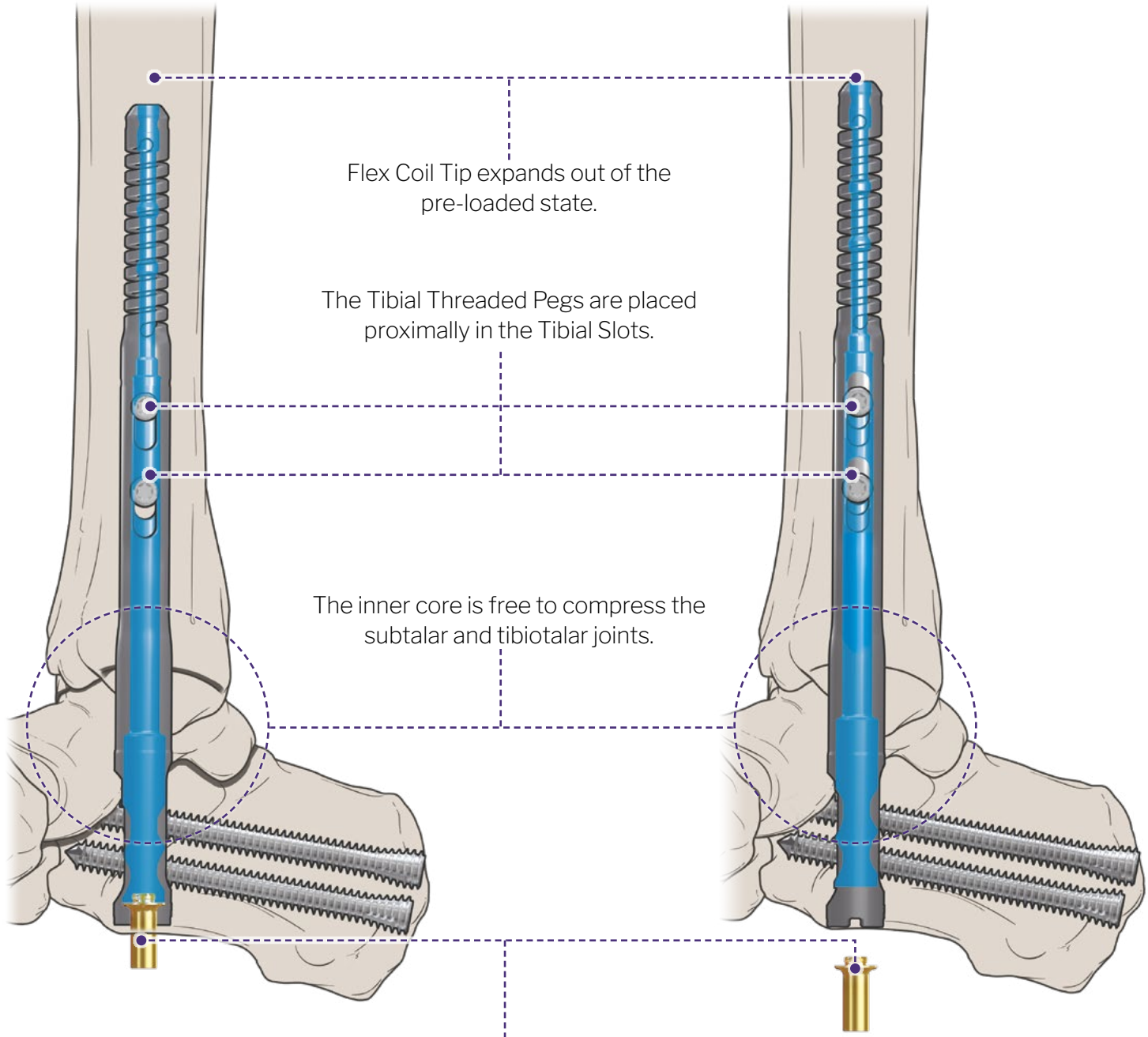

Flex Coil Tip expands out of the pre-loaded state.

The Tibial Threaded Pegs are placed proximally in the Tibial Slots.

The inner core is free to compress the subtalar and tibiotalar joints.

Upon initial release of the Tension Screw, the inner core translates proximally. The Calcaneal Threaded Pegs stay fixated in the bone and cause the calcaneus to be pulled proximally.

PRECISION[®] GUIDE FEATURES

- PRECISION Guide Technology guides the initial placement of the Ø3.0 mm Drill-Pin in the distal to proximal direction
- Designed to reduce the number of Drill-Pin placement attempts to set Nail trajectory
- Termination point of the Sphere Wire is designed to be centered in the tibial canal to determine trajectory of the Drill-Pin
- Drill-Pin fluted tip design helps to prevent skiving

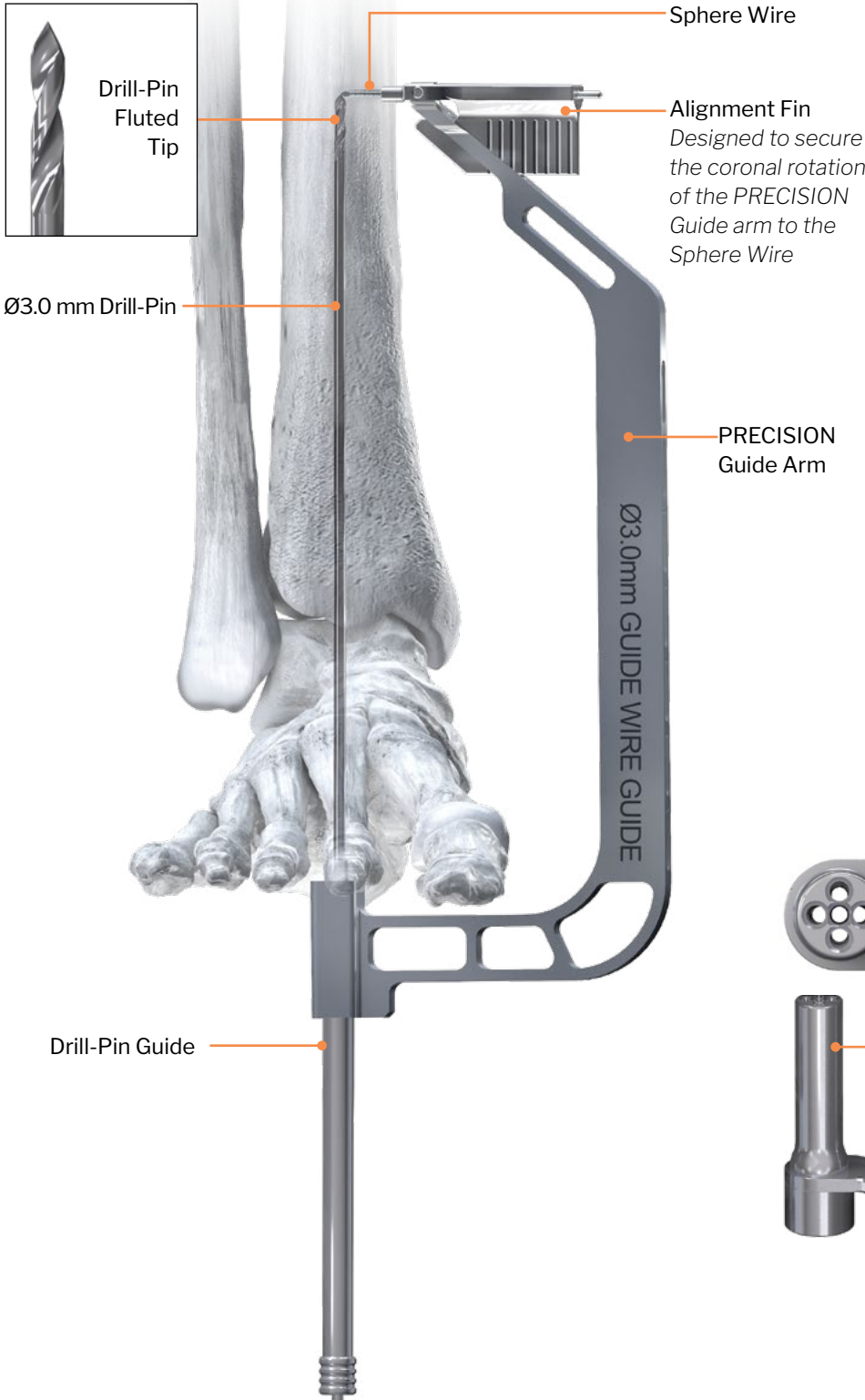

GHOST™ OUTRIGGER FEATURES



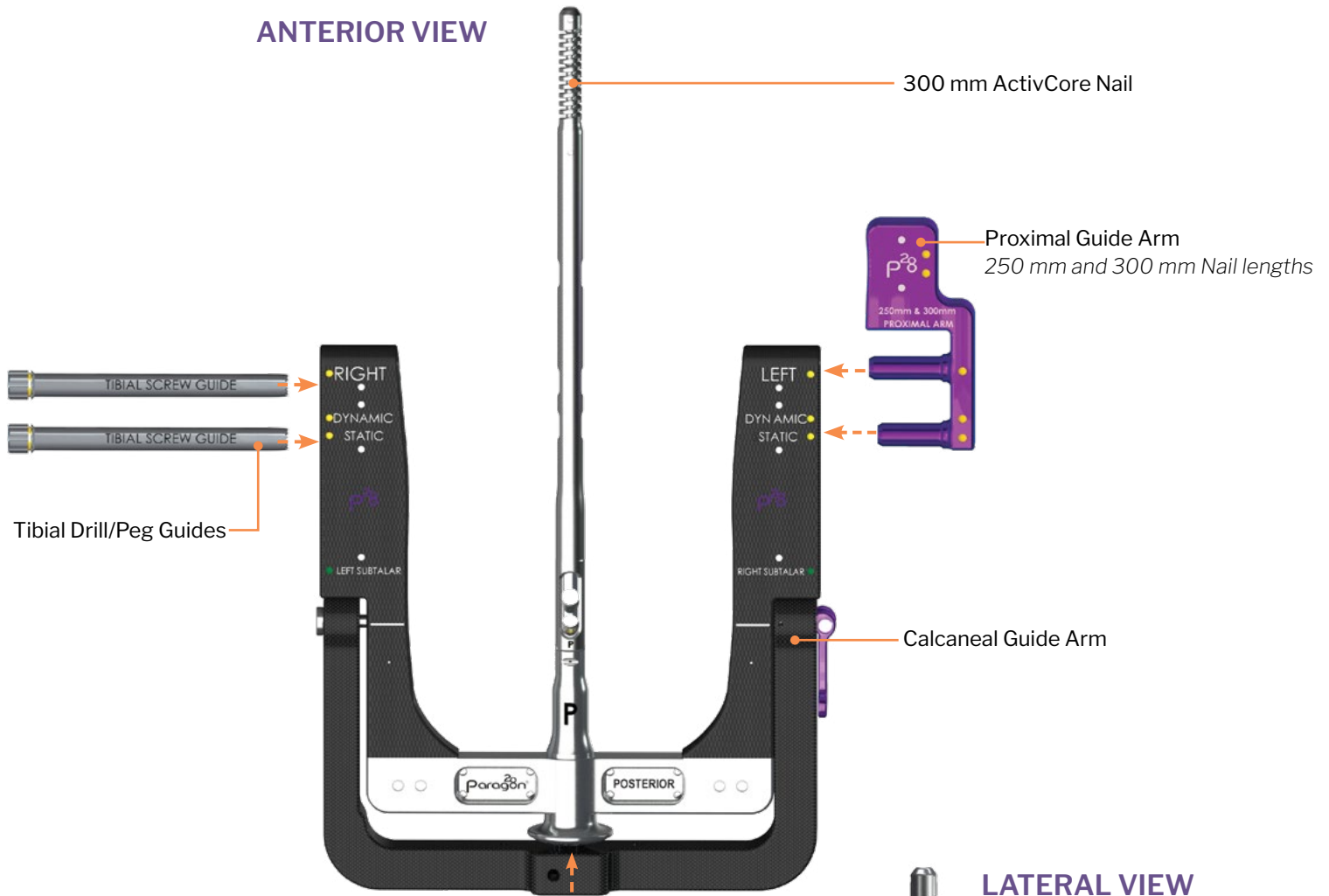



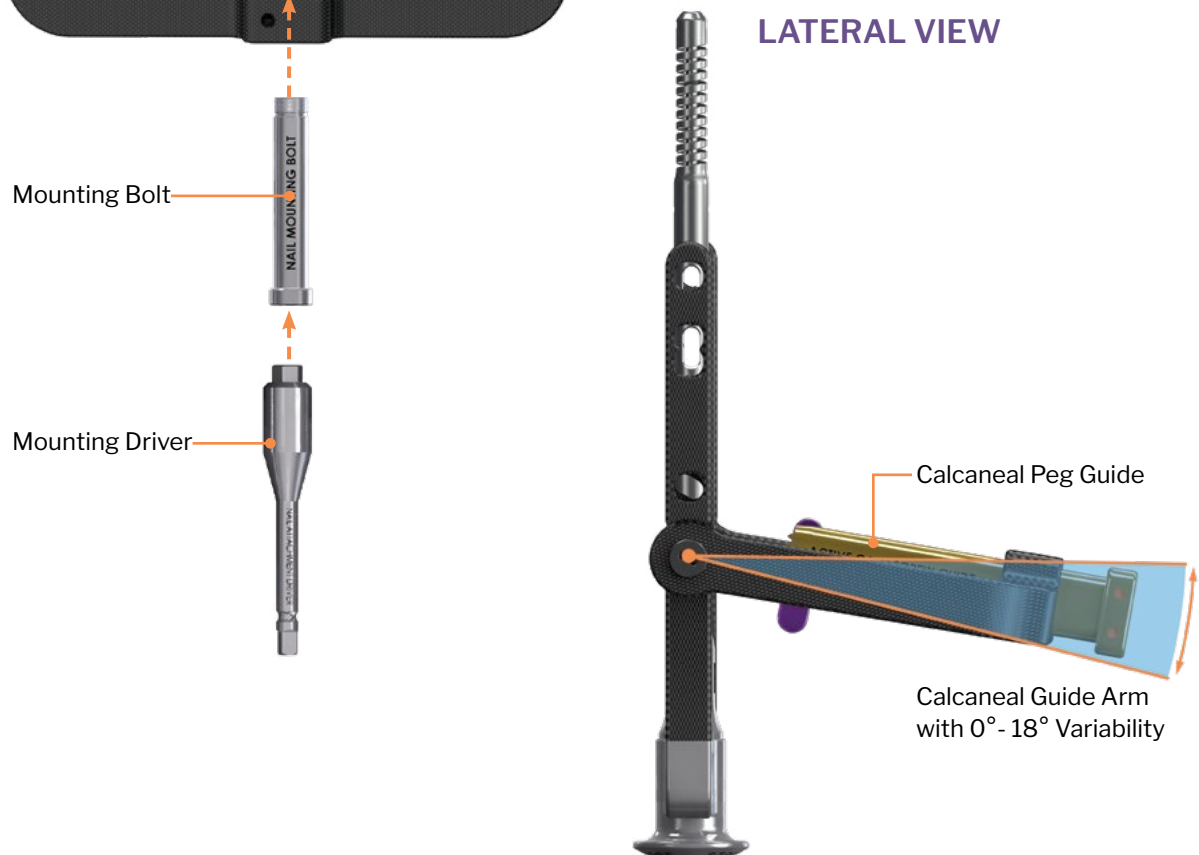







ANTERIOR VIEW



LATERAL VIEW



PHANTOM ACTIVCORE™ NAIL SYSTEM IMPLANTS

	TIBIAL THREADED PEG	CALCANEAL THREADED PEG	
			
DIAMETER:	Ø5.0 mm	Ø7.2 mm	
LENGTH:	20 mm - 70 mm in 2 mm increments	45 mm - 120 mm in 5 mm increments	
COLOR INSTRUMENTS:			
DRIVER:	TX-20 - Long 	TX-30 - Long 	
DRILL:	Ø3.8 mm x 250 mm 	Ø4.6 mm x 300 mm - Solid 	Ø4.6 mm x 300 mm - Cannulated 
DRILL GUIDE:	Tibial Drill Guide 	Calcaneal Drill Guide 	
PEG GUIDE:	Tibial Peg Guide 	Calcaneal Peg Guide 	
K-WIRE:	-	Ø2.3 mm 	
K-WIRE GUIDE:	-	Ø2.3 mm 	

SHOULDERED END CAP OPTIONS

- Placed in Nail after Threaded Peg placement and Outrigger removal
- Fills the countersink void and helps to prevent bone ingrowth at the distal end of the Nail
- Longer shoulder (bottom image) fills larger countersink void



JOINT PREPARATION INSTRUMENTATION

Bone Fenestration Perforator



Oval Burr



Barrel Burr



Curved Bone Fenestration Chisel



Straight Bone Fenestration Chisel



Honeybadger



Straight Ring Curette



Straight Curette



Angled Ring Curette



Angled Curette



Straight 3 mm Osteotome



Curved 3 mm Osteotome



Straight 6 mm Osteotome



Curved 6 mm Osteotome



Straight 12 mm Osteotome



Curved 12 mm Osteotome



Hindfoot Distractor

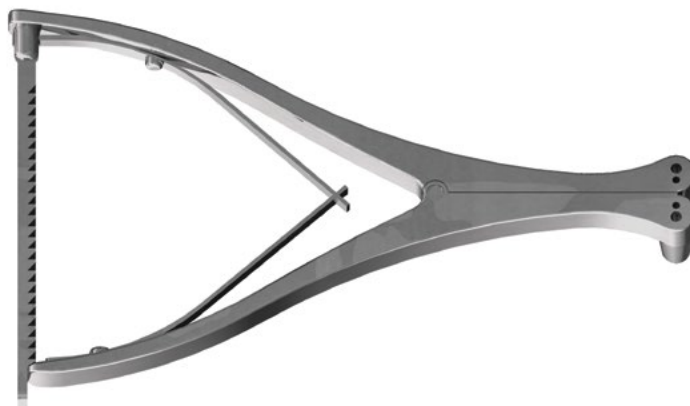

Ø2.0 mm K-wire



Ø2.3 mm K-wire



INSTRUMENTATION

Ø3.0 mm Drill-Pin



Ø7.0 mm Entry Drill



Ø13.5 mm Stepped Reamer



Ball-Tipped Guide Rod

(Available in Ø3.0 mm x 550 mm and Ø3.0 mm x 800 mm)

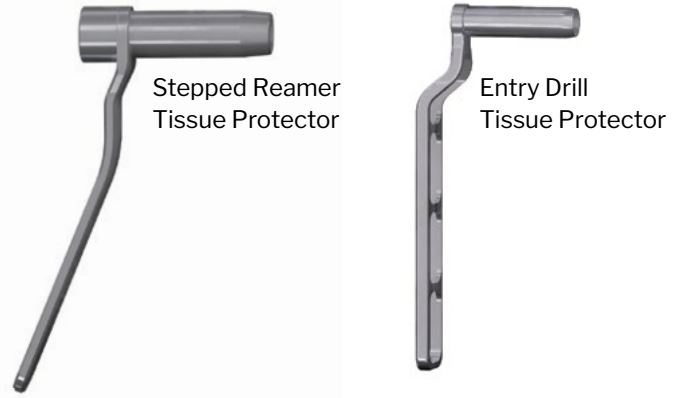

345 mm Flexible Reamer Shaft

(For all Nails up to 250 mm length)

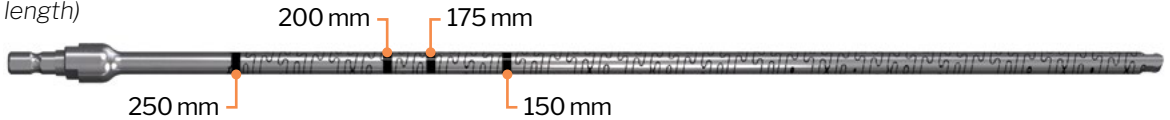

417 mm Flexible Reamer Shaft

(For all Nail lengths)

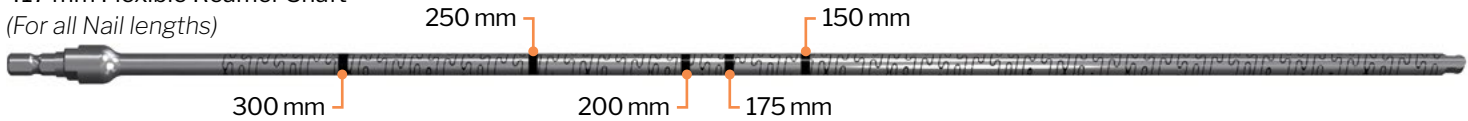

REAMER HEADS



Thor Hammer



Slap Hammer



Jacobs Adapter



Cannulated Depth Gauge



Solid Depth Gauge



Handle



T-Handle

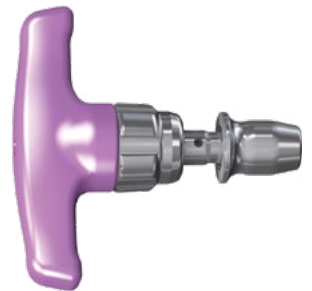

TX-20 Driver

(Available in short and long)



TX-30 Driver

(Available in short and long)



PATIENT POSITIONING

Patient positioning is per surgeon preference, and may depend on the pathology and/or previous surgical approaches for a particular patient. Patient positioning options include supine with an ipsilateral bump, lateral decubitus, or prone.

A radiolucent table is recommended for this procedure. Prepare the entire foot and lower limb such that the patient is draped above the knee and visualization of the knee and lower limb is present to allow for assessment of lower limb alignment. The distal limbs should extend just over the operating room table. A large C-arm should be available for entry over the operative site from the contralateral side.

INCISION/EXPOSURE – TIBIOTALAR AND SUBTALAR JOINTS

Pre-existing deformities can be addressed and corrected at this time. Anatomical considerations may determine the surgeon's preferred approach to access the tibiotalar and subtalar joints for cartilage removal and alignment. A pin distractor is provided to allow for space and visualization during joint preparation, if needed, and is to be used with provided $\varnothing 2.0$ mm or $\varnothing 2.3$ mm K-wires.

Prepare the tibiotalar joint and the anterior, middle, and posterior facets of the subtalar joint for arthrodesis according to surgeon's preferred technique and approach using the provided joint preparation instrumentation. Following cartilage removal, it is advised to fenestrate the subchondral plate with the subchondral drill, burrs, and/or bone fenestration chisels to promote healing.

TIBIOTALAR AND SUBTALAR JOINT POSITIONING AND TEMPORARY FIXATION

Align the tibiotalar and subtalar joint. The tibiotalar joint should be positioned neutral with respect to dorsiflexion and plantarflexion. The foot should be in 5° of hindfoot valgus and 0° - 5° of calcaneal external rotation equal to the contralateral side.⁴ Medialization of the calcaneus or talus may be necessary to allow for better positioning of the calcaneus and talus inferior relative to the tibia.

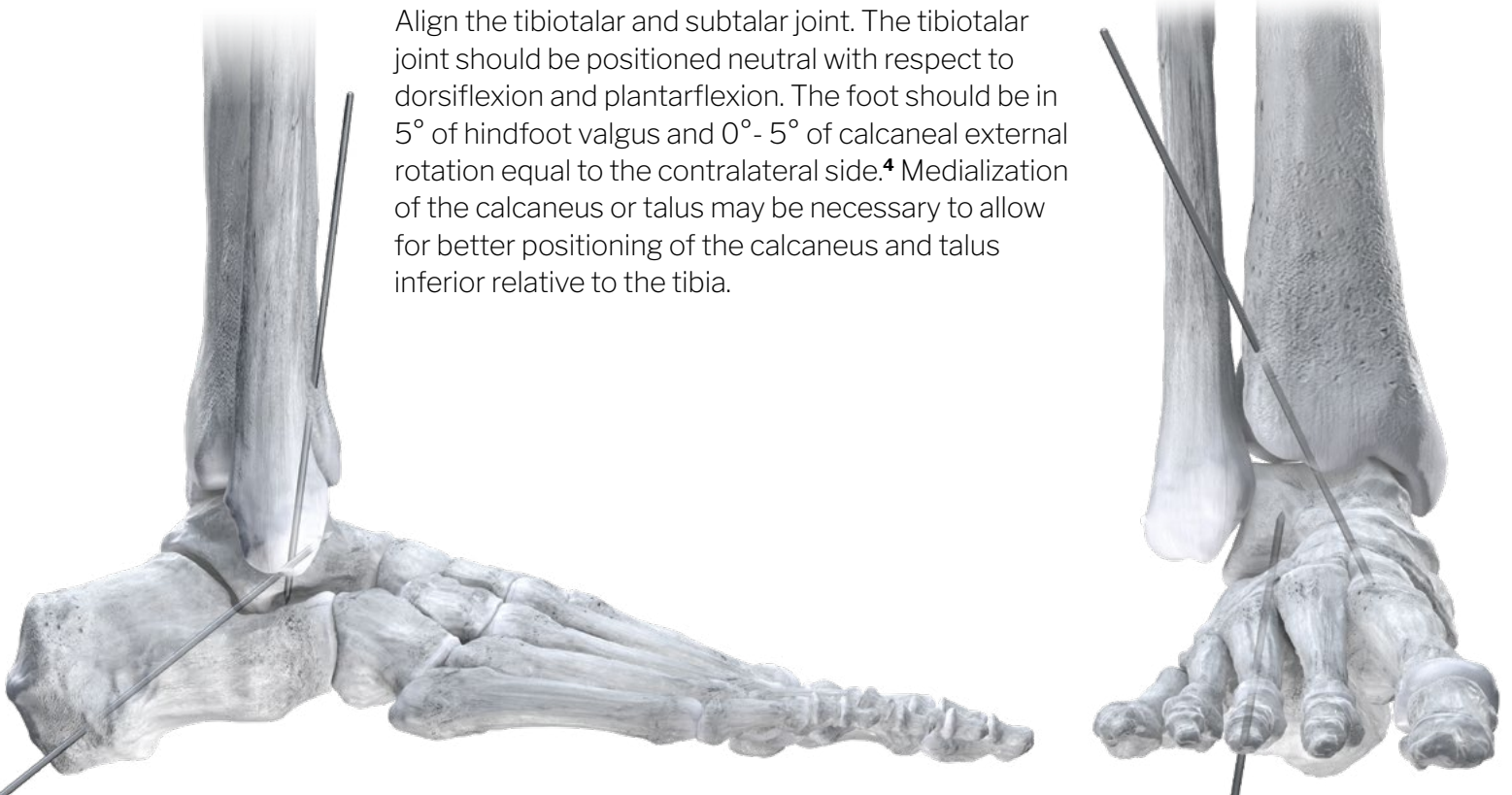

With the subtalar joint and tibiotalar joint held in this alignment, use the provided $\varnothing 2.0$ mm K-wires to temporarily fix the tibiotalar joint and the subtalar joint in the preferred alignment. The K-wire across the tibiotalar joint should pass from the anterolateral tibia to the anteromedial talus, avoiding the anticipated path of the Nail. The K-wire across the subtalar joint should be placed laterally.

IMPLANT SIZING

IMPLANT SIZER

Place the Implant Sizer over the medial or lateral side of the leg, amenable to patient positioning. Ensure a proper lateral view of the leg is viewed on fluoroscopy using the Fluoro Alignment Hole. The Fluoro Alignment Hole should be fully in view to confirm that proper rotation of the Implant Sizer relative to the C-arm is established.

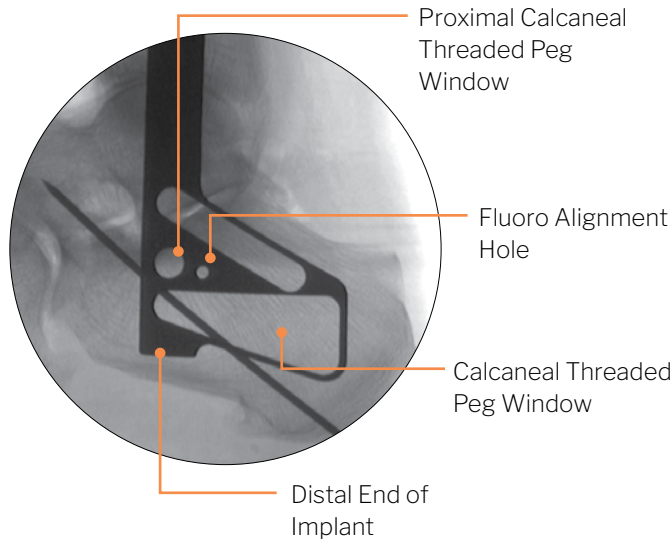

Perform the following checks to anticipate position of the Nail:

- Ensure the Tibial Slots are in proper positioning and above the tibiotalar joint.
- Ensure the Calcaneal Threaded Peg Window is in the calcaneus with an appropriate start point.
- Ensure the Proximal Calcaneal Threaded Peg Window is in the calcaneus with an appropriate position.
- Ensure the distal end of the Implant Sizer is 5 mm countersunk in preparation for compression.

LENGTH MEASUREMENT NOTCHES

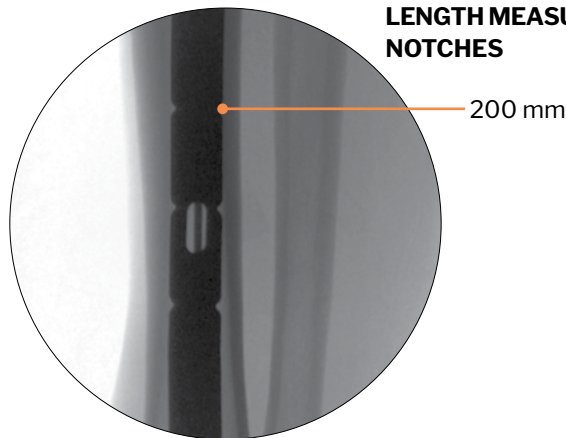

The appropriate Nail length can be determined within the tibia utilizing the Length Measurement Notches.

- Nail length offerings include: 200 mm (shown) and 250 mm, 300 mm (not shown).

Distal Tibial Slot*

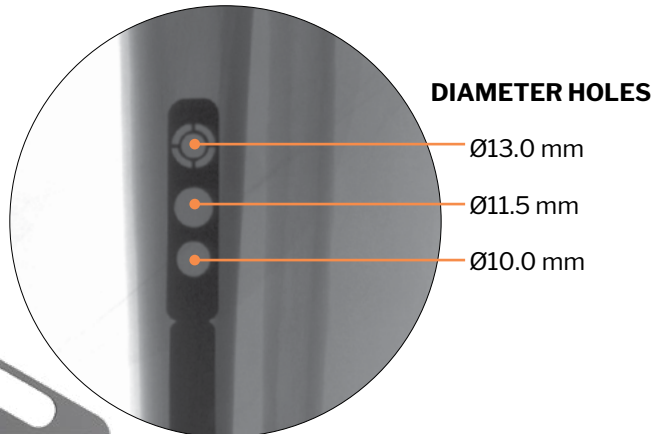

Slide the Implant Sizer distally such that the Diameter Holes are over the projected proximal termination point of the Nail.

- Determine approximate Nail diameter by selecting which Diameter Hole best fills the tibia canal without violating the cortex.

* (Slot below Distal Tibial Slot does not correspond to a tibial peg location)

ESTABLISH ENTRY POINT INCISION AND DRILL-PIN INSERTION

A PRECISION® Guide is available for Drill-Pin placement, with instructions below for setup and use. If the PRECISION Guide is not used, proceed to page 18 for freehand Drill-Pin insertion instructions.

USE OF THE PRECISION GUIDE FOR DRILL-PIN PLACEMENT

Position the distal end of the PRECISION Guide approximately one finger breadth plantar to the fat pad of the heel, with the proximal aspect of the PRECISION Guide Arm positioned along the anterior medial face of the tibia. Mark the entry point for the Sphere Wire and make a small stab incision at the area of intended Sphere Wire placement centrally over the anterior medial face of the tibia. Position the Sphere Wire perpendicular to the anterior medial face of the tibia and parallel to the neutral foot.

Insert the Sphere Wire until the “can” portion contacts bone.

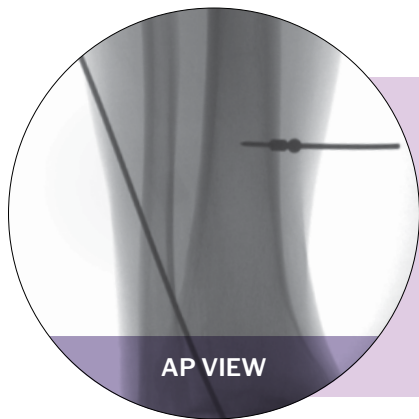

Confirm placement using an AP view on fluoroscopy to ensure that the tip of the Sphere Wire is centered in the medullary canal.

The Drill-Pin's trajectory will terminate at the tip of the Sphere Wire, thus the Sphere Wire insertion depth may need to be adjusted according to patient anatomy.

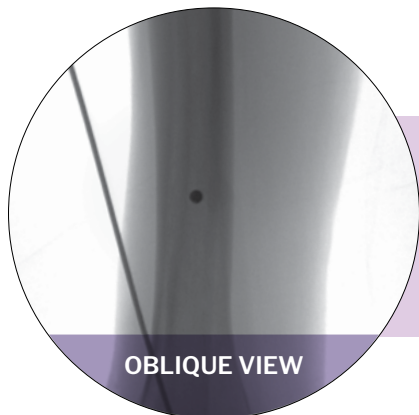

Take an oblique fluoroscopic view down the center of the Sphere Wire to ensure it is centered in the anterior medial face of the tibia.

USE OF THE PRECISION® GUIDE FOR DRILL-PIN PLACEMENT



Attach the PRECISION Guide Arm to the Sphere Wire proximally.

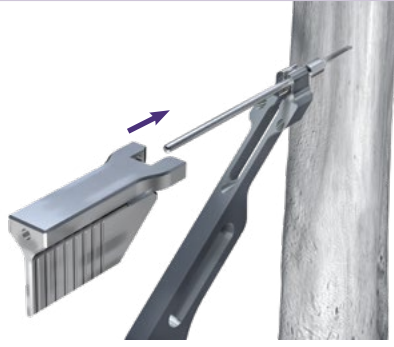

Insert the PRECISION Guide Alignment Fin such that the hole in the Alignment Fin receives the Sphere Wire. The fin portion is inserted into the oblong recess of the PRECISION Guide Arm to allow the two prongs of the fin to grasp the sphere.

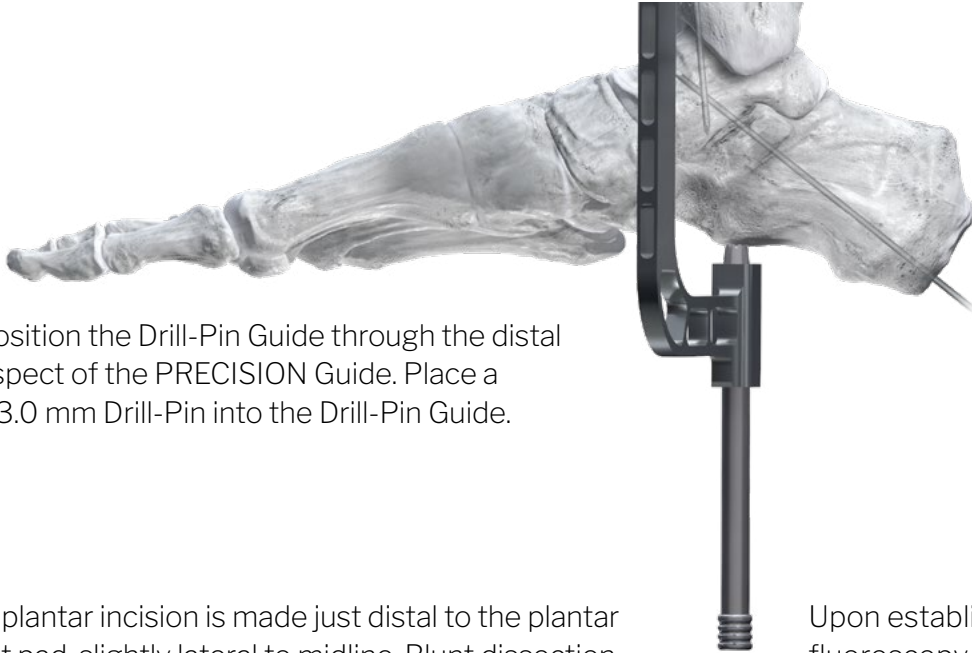

Position the Drill-Pin Guide through the distal aspect of the PRECISION Guide. Place a Ø3.0 mm Drill-Pin into the Drill-Pin Guide.

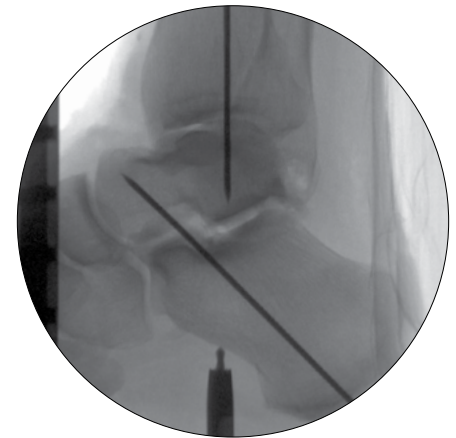

Confirm intended Drill-Pin start point via lateral fluoroscopy.

A plantar incision is made just distal to the plantar fat pad, slightly lateral to midline. Blunt dissection is carried down to the plantar calcaneus to avoid disruption of nearby neurovascular bundles. The tip of the Ø3.0 mm Drill-Pin is placed against the plantar aspect of the calcaneus. A lateral fluoroscopic image is taken to ensure correct distal to proximal trajectory of the Drill-Pin.

Upon establishing the correct start point on lateral fluoroscopy, drive the Ø3.0 mm Drill-Pin into the calcaneus, talus, and tibia using AP, lateral, and calcaneal axial fluoroscopic views during and after the process. Ensure that the Drill-Pin is centered in the calcaneus, talus, and tibia to terminate in the medullary canal of the tibia, just proximal to the metaphyseal flair.

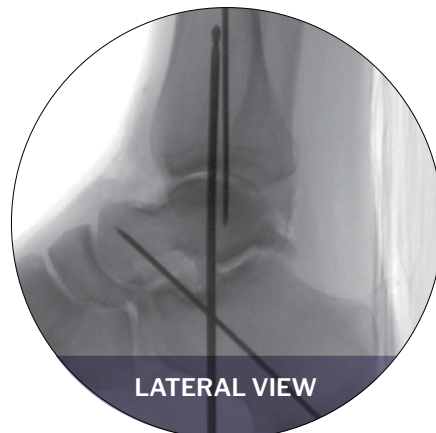
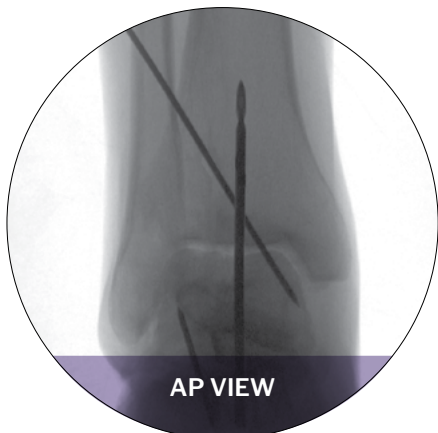

USE OF THE PRECISION® GUIDE FOR DRILL-PIN PLACEMENT



Remove the Alignment Fin from the Sphere Wire and remove the Drill-Pin Guide from the PRECISION Guide Arm. Detach the PRECISION Guide Arm from the Sphere Wire and slide over the Drill-Pin.

Remove the Sphere Wire from the tibia.

ALTERNATIVE: FREEHAND DRILL-PIN INSERTION

A plantar incision is made just distal to the plantar fat pad, slightly lateral to midline. Blunt dissection is carried down to the plantar calcaneus to avoid disruption of nearby neurovascular bundles. The tip of the Ø3.0 mm Drill-Pin is placed against the plantar aspect of the calcaneus. A lateral fluoroscopic image is taken to ensure correct distal to proximal trajectory of the Drill-Pin.

Upon establishing the correct start point, drive the Ø3.0 mm Drill-Pin into the calcaneus, talus and tibia using AP, lateral and calcaneal axial fluoroscopic views during and after the process to ensure that the Drill-Pin is centered in the calcaneus, talus, and tibia to terminate in the medullary canal of the tibia, just proximal to the metaphyseal flare as shown on page 17.



OPTIONAL: USE OF THE PARALLEL OFFSET GUIDE

If angulation of the Drill-Pin is suitable, but the Drill-Pin position is too anterior, posterior, medial or lateral, the Parallel Offset Guide can be used. Slide the Parallel Offset Guide central hole over the initial Drill-Pin. Place a second wire in any of the adjacent holes to allow for this second Drill-Pin to be placed parallel to the first, offset 4 mm center-to-center in any direction. Remove the initial Drill-Pin and the Parallel Offset Guide.

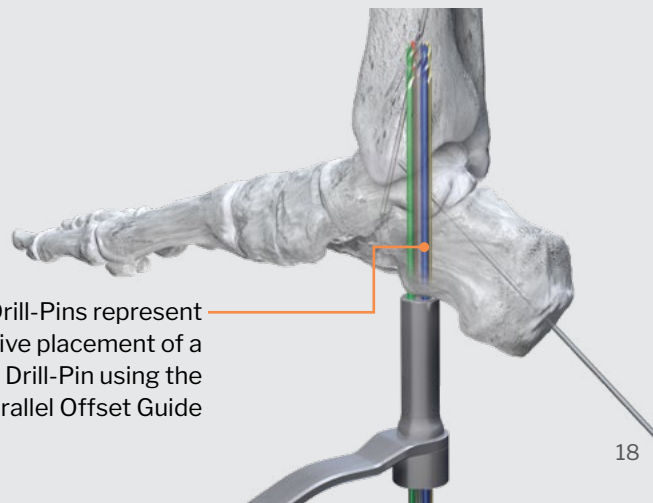

Colored Drill-Pins represent alternative placement of a second Drill-Pin using the Parallel Offset Guide

ENTRY DRILLING



An extension of the plantar incision is made, if necessary, such that the plantar incision measures 3-4 cm. Perform blunt dissection to the plantar surface of the calcaneus as needed. Place the Entry Drill Tissue Protector over the Drill-Pin and position within the incision and against the calcaneal cortex.



Insert the Entry Drill Tissue Protector and the Ø7.0 mm Entry Drill over the Drill-Pin, and advance the Drill proximally, confirming the drill path trajectory under fluoroscopy at each joint. Drill past the metaphyseal flare in the tibia. Remove the Ø7.0 mm Entry Drill and Entry Drill Tissue Protector while maintaining the position of the Drill-Pin.

STEPPED REAMING

Insert the Stepped Reamer Tissue Protector and Stepped Reamer over the Drill-Pin. Ream proximally until the laser mark on the Stepped Reamer reaches the Tissue Protector.



TIP: Insert the Stepped Reamer Tissue Protector and Stepped Reamer over the Drill-Pin. Ream proximally until the laser mark on the Stepped Drill reaches the Tissue Protector.

It is recommended to check lateral fluoroscopy to ensure that the larger Ø13.5 mm diameter contacts the metaphyseal bone of the tibia and that the proximal portion of the drill matches the intended countersink of the Nail.

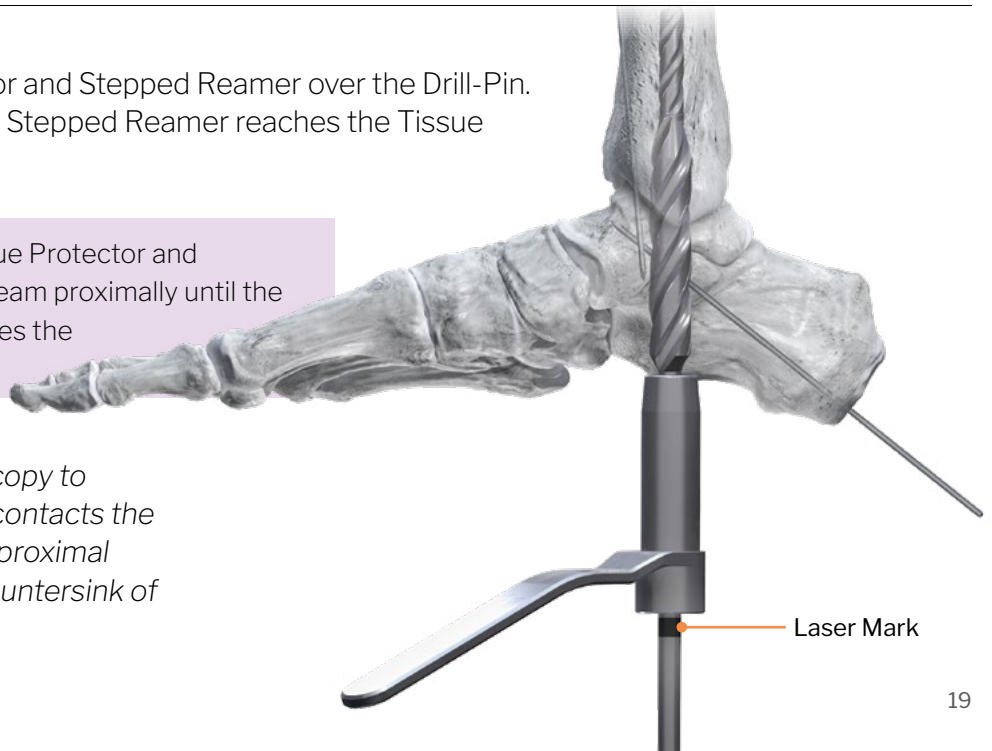

FLEXIBLE REAMING

Following stepped reaming, remove the Drill-Pin, and place the Ball-Tipped Guide Rod from the plantar aspect of the calcaneus into the distal tibia. Temporary fixation can be removed at this time or after placement of the Nail, per surgeon preference. The Thor Hammer may be used to fully seat the Ball-Tipped Guide Rod within the canal. Confirm position and length of the Ball-Tipped Guide Rod using fluoroscopy.



Attach the desired Reamer Head to the Reamer Shaft. It is recommended to begin with the smallest diameter Reamer Head (Ø8.0 mm), thus creating a Reamer Construct.

Insert the Stepped Reamer Tissue Protector over the Ball Tipped Guide Rod into the incision. Using the Reamer Construct, ream over the Ball-Tipped Guide Rod until the laser marking on the Reamer Shaft meets the Tissue Protector. Ream incrementally in Ø0.5 mm increments, increasing in size until desired resistance is reached while confirming under fluoroscopy. It is recommended to undersize the Nail diameter by Ø1.0 - Ø1.5 mm from the largest reamed diameter. Remove the Ball-Tipped Guide Rod from the tibial canal once reaming is complete.



TIP: While under power, the reverse function can help to alleviate resistance during Reamer Construct withdrawal from the tibial canal.



Laser Mark for Nail Lengths

NOTE: While removing the Reamer Construct during incremental reaming, the Thor Hammer can be used as a stop to prevent extraction of the Ball-Tipped Guide Rod.

NAIL ASSEMBLY

1 The Phantom ActivCore™ Nail is packaged with the Tension Screw preloaded in the distal aspect.



2 Open the Cam Lock along the Calcaneal Guide Arm.

3 Swing the Calcaneal Guide Arm to access the plantar end of the Outrigger. Close the Cam Lock with the Calcaneal Guide Arm in the angled position.



NOTE: In the first few uses, the Cam Lock may appear slightly open 10° - 15° when in the locked position. Over time and with repeated use, the Cam Lock will be flush with the Outrigger body when locked.



First uses: 10° - 15° opened



Over time: Flush

4 Attach the Mounting Driver to the provided Handle.



NAIL ASSEMBLY

- 5 Align the prongs of the Nail to the prongs of the Outrigger. The “P” (posterior) on the Nail should align with the “P” on the Outrigger.



- 6 Insert the Mounting Bolt through the plantar end of the Outrigger.

- 7 Secure the Nail by placing the Mounting Driver through the plantar end of the Outrigger and turn in a clockwise direction.



ALIGNMENT CHECK

- 8** To set up the Tibial Guides, insert the Tibial Drill Guide into the Tibial Peg Guide and thread together in a clockwise direction.

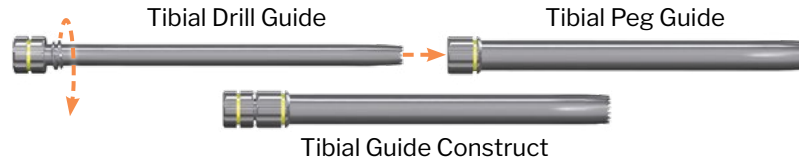

- 9** Insert the Tibial Guide Construct medially.

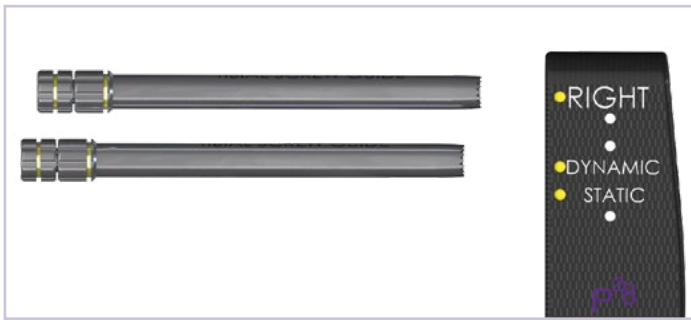

- 10** Insert each Tibial Peg Guide into the dynamic tibial Outrigger hole. Verify choice of dynamic or static placement.

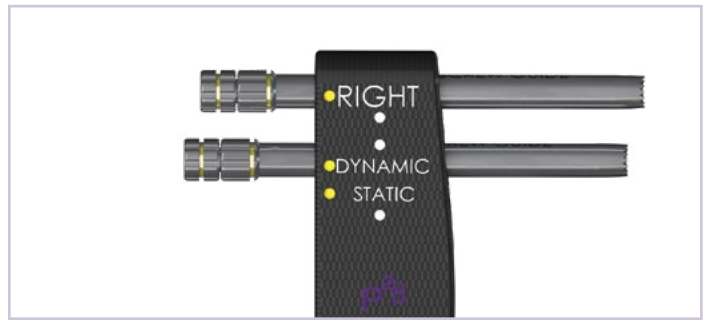

- 11** Insert the K-wire Guide into the superior position of the Calcaneal Peg Guide. Insert the Calcaneal Drill Guide into the inferior position of the Calcaneal Peg Guide. Insert the Calcaneal Guide Construct into the Calcaneal Guide Arm of the Outrigger, with the K-wire Guide superior.

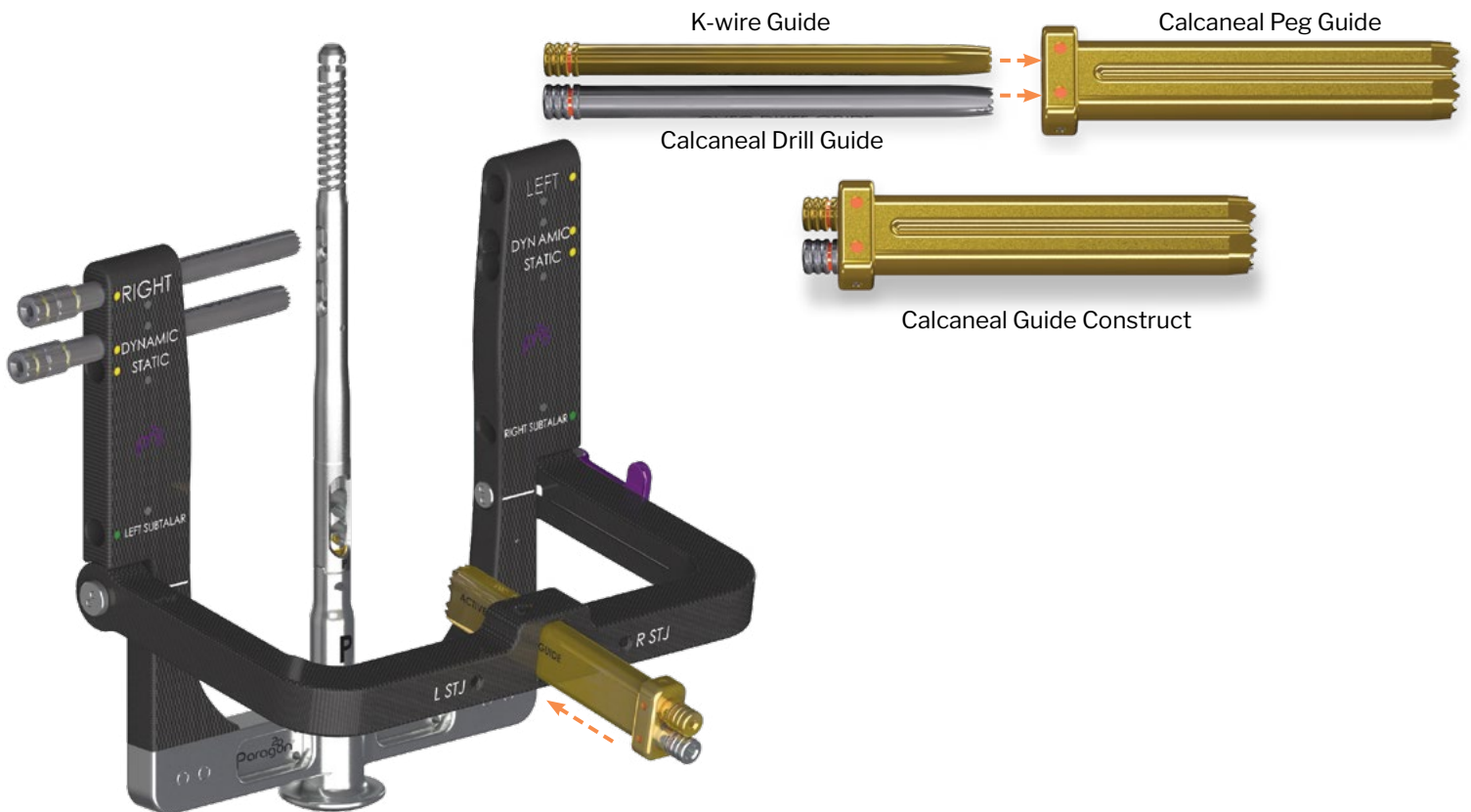

ALIGNMENT CHECK

- 12 Insert the $\varnothing 3.8$ mm Drills into each Tibial Guide Construct to ensure that the drills pass through the slot in the Nail at the dynamic position. Insert the $\varnothing 2.0$ mm x 200 mm K-wire into the K-wire Guide to ensure it passes through the Nail at the desired position.



- 13 Insert the $\varnothing 4.6$ mm Drill into the Calcaneal Drill Guide to ensure the Drill passes through the Nail at the desired position.

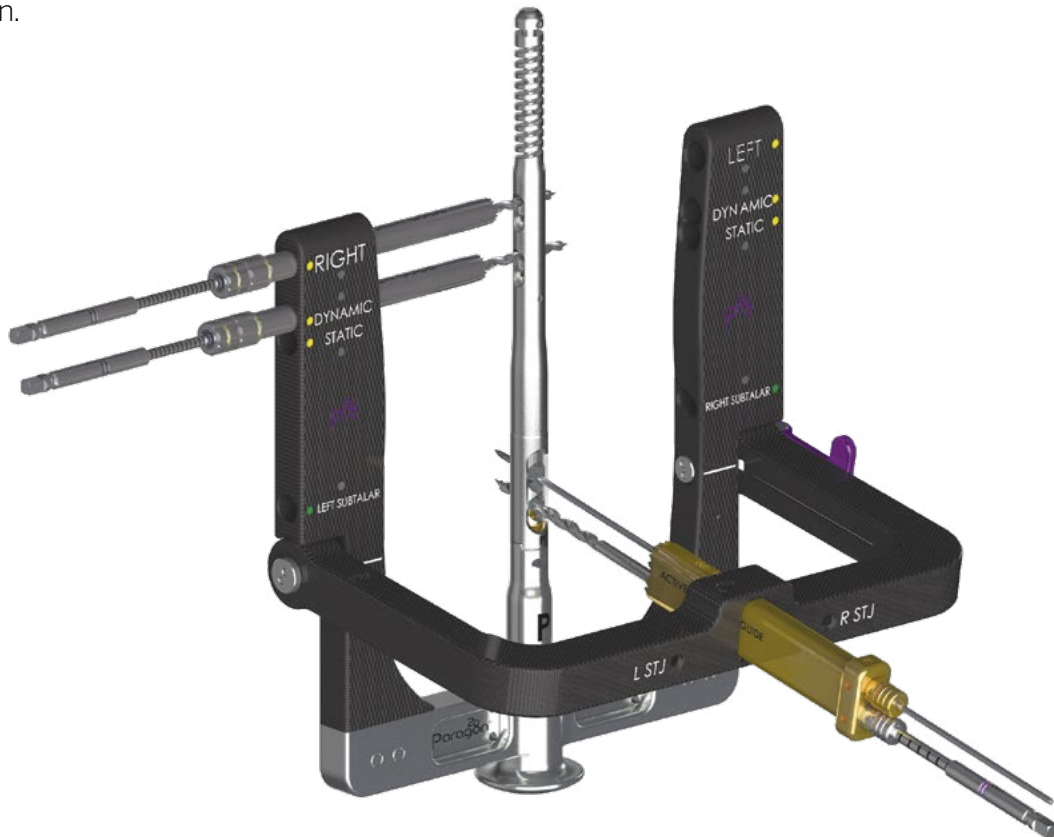

NAIL INSERTION

Three position checks are important to ensure correct positioning of the Nail prior to Threaded Peg insertion: **CALCANEAL THREADED PEG TRAJECTORY, SUPERIOR/INFERIOR INSERTION DEPTH AND NAIL ROTATION**

1 CALCANEAL THREADED PEG TRAJECTORIES

Open the Cam Lock on the Calcaneal Guide Arm and swivel the arm superiorly into the preferred position for Threaded Peg trajectory. A relatively flat Calcaneal Threaded Peg trajectory is recommended to achieve additional bony purchase anteriorly and respect the calcaneocuboid and subtalar joints.

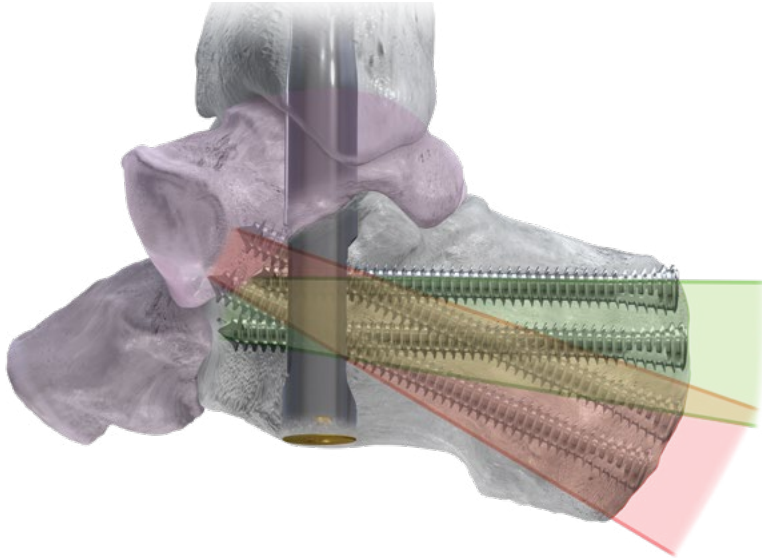

Recommended:

A relatively flat trajectory is recommended for Calcaneal Threaded Peg placement. This trajectory achieves additional bony purchase and respects the calcaneocuboid and subtalar joints.

Not Recommended:

A steeper trajectory has a higher risk to violate these joint spaces which inhibits the ActivCore Nail from applying constant compression.

Open the Cam Lock on the Calcaneal Guide Arm and swivel the Arm superiorly into the preferred position. The 18° of adjustability is noted on the Outrigger when the white stripe on the Outrigger is within the thick white line on the Calcaneal Guide Arm. The Cam Lock will only close when the white stripe is within the thick white line, or, if viewing from the side, the white stripe must be within the angled white box. Close the Cam Lock when desired positioning is achieved.

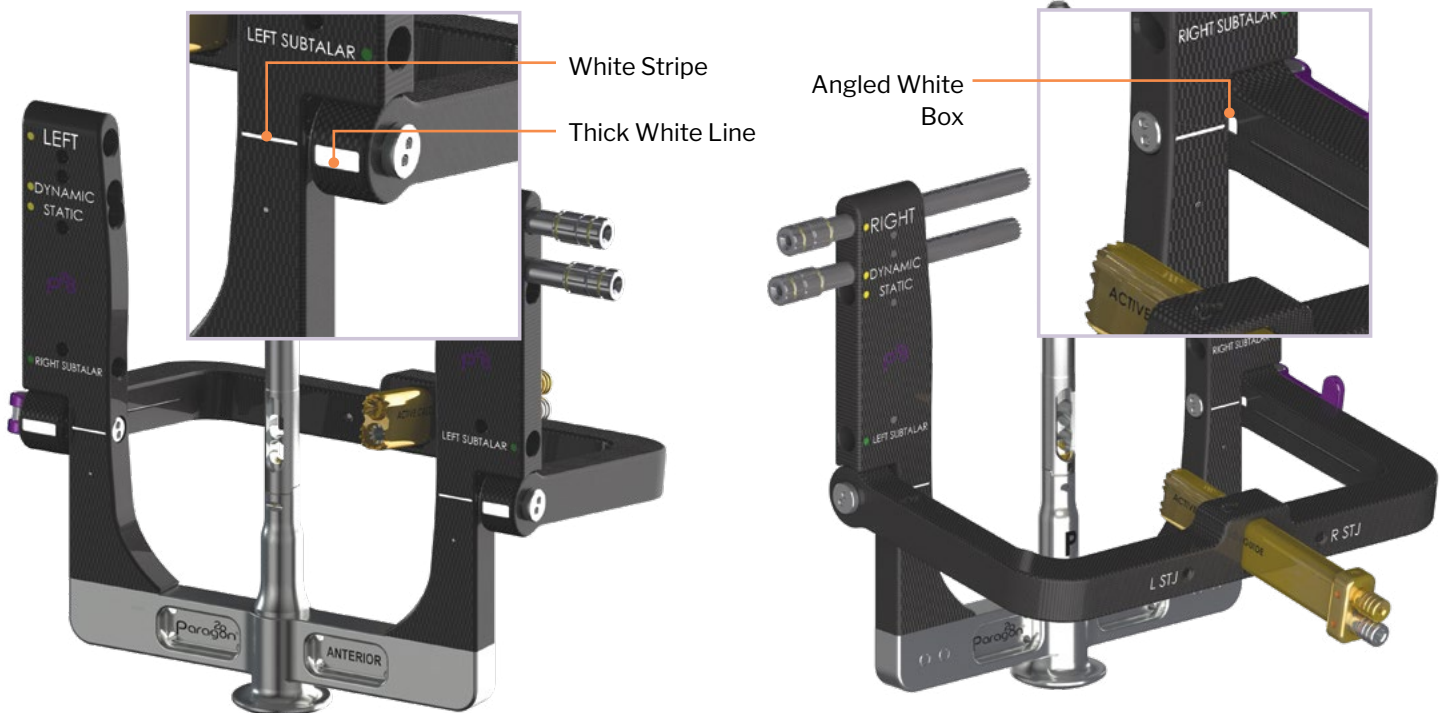

NAIL INSERTION

2 SUPERIOR/INFERIOR INSERTION DEPTH

Insert the Nail and attached Outrigger into the reamed canal. Use the Thor Hammer to tap the Outrigger strike plate until the Nail is fully seated. Do not strike the Calcaneal Guide Arm. Confirm Nail size and placement using fluoroscopy.

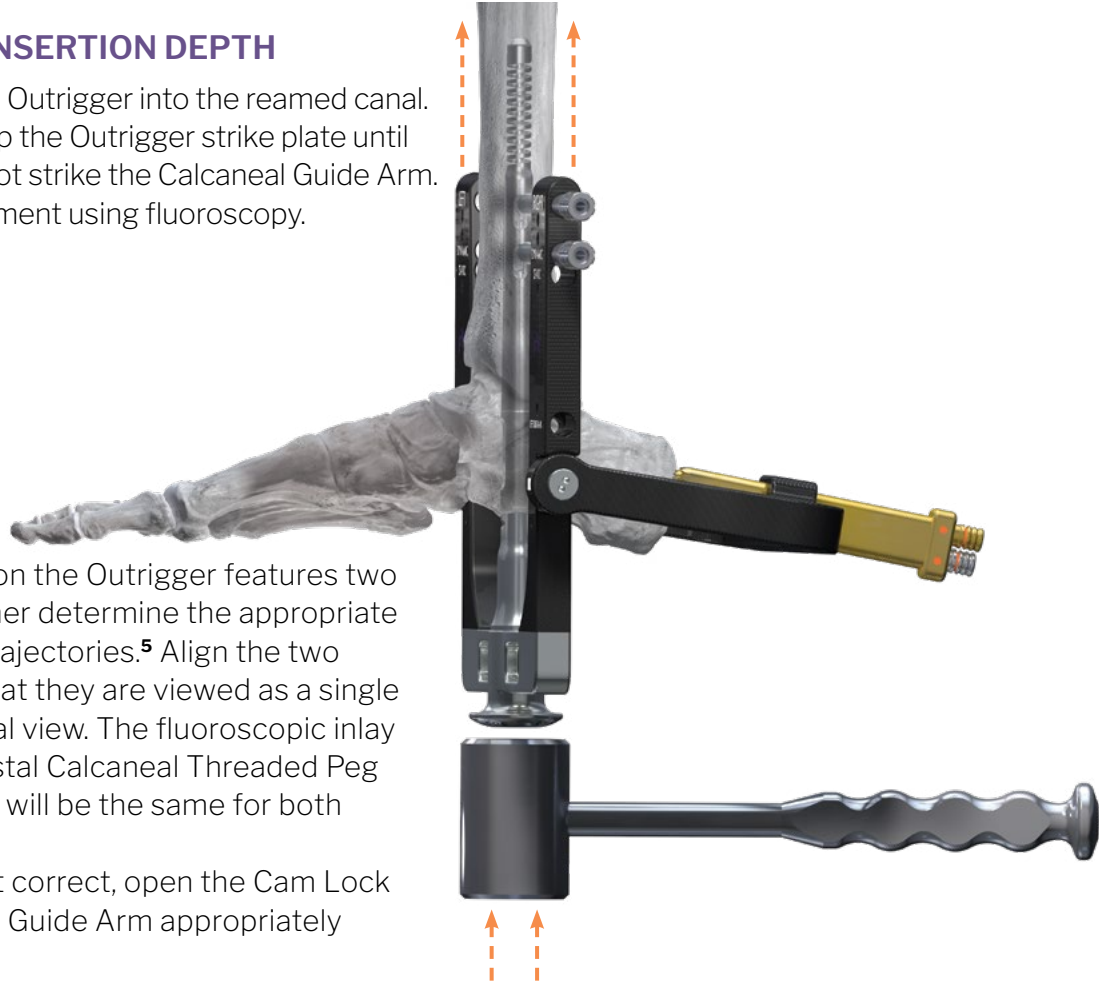

The Calcaneal Guide Arm on the Outrigger features two fluoroscopic inlays to further determine the appropriate Calcaneal Threaded Peg trajectories.⁵ Align the two fluoroscopic inlays such that they are viewed as a single line to indicate a true lateral view. The fluoroscopic inlay alignment will show the distal Calcaneal Threaded Peg trajectory. The trajectories will be the same for both Calcaneal Threaded Pegs.

If the inlay alignment is not correct, open the Cam Lock and readjust the Calcaneal Guide Arm appropriately using fluoroscopy.

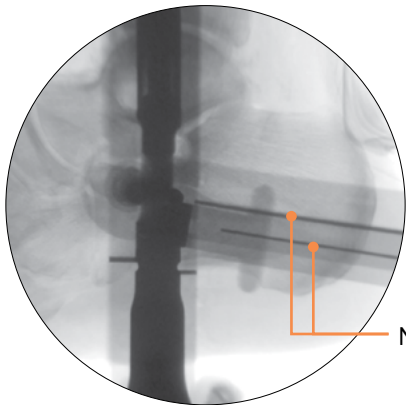

Not Aligned

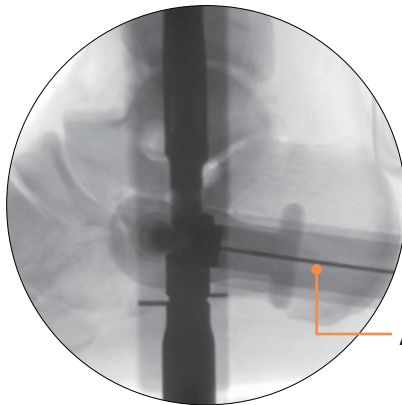

Aligned

Assess the trajectory of the inferior Calcaneal Threaded Peg by observing the fluoroscopic inlays when they are in the aligned state. Then, observe the projected trajectory and location of the superior Calcaneal Threaded Peg by looking at the superior window within the Nail.

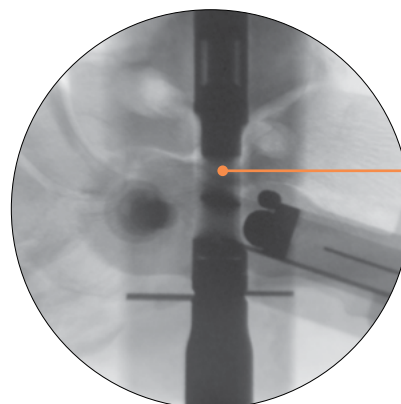

Superior Calcaneal
Threaded Peg
Window

NAIL INSERTION

2

SUPERIOR/INFERIOR INSERTION DEPTH

Confirm all of the checkpoints below to achieve proper Nail insertion depth:

- Ensure that the projected trajectory of the Calcaneal Threaded Pegs are within the calcaneus and that the superior peg will not violate the subtalar joint.
- Recommended placement of the Nail is 5 mm past the plantar cortex of the calcaneus to account for intended internal compression and avoid plantar Nail prominence. An Insertion Depth Fluoroscopic Marker is located on the Outrigger to indicate 5 mm distal to the Nail end. It is recommended that this fluoroscopic marker is flush to the plantar surface of the calcaneus. If the Implant Sizer indicated that a deeper or shallower depth is necessary, adjust as needed.
- Confirm that the two Tibial Threaded Peg positions are within the tibia in the desired position.
- Re-assess the trajectories of Calcaneal Threaded Pegs to ensure the desired trajectory is achieved.



Tibial Threaded
Peg Slots

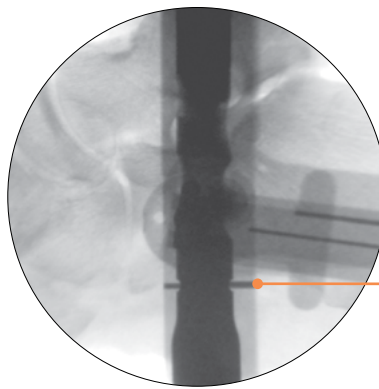

Insertion Depth
Fluoroscopic Marker

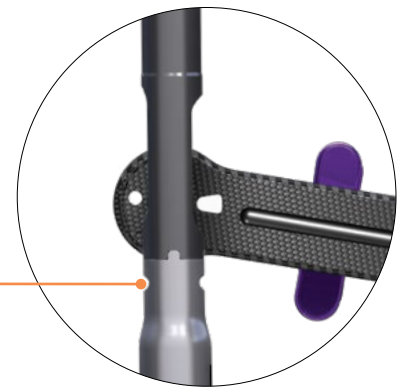

3

NAIL ROTATION

Recommended: Position the Calcaneal Threaded Pegs center to center-medial to achieve additional bony purchase.

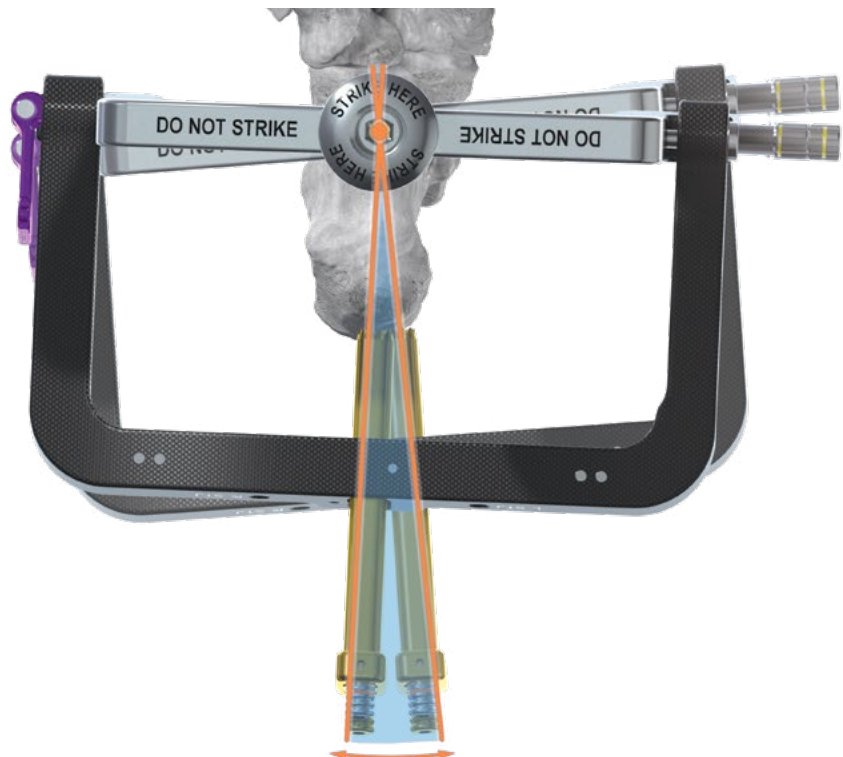

CALCANEAL THREADED PEG INSERTION



Insert a $\varnothing 2.0$ mm x 200 mm K-wire into the K-wire Guide within the Calcaneal Guide Arm in the desired position. Confirm K-wire placement and Calcaneal Threaded Peg trajectory by taking a calcaneal axial view using fluoroscopy.



Once appropriate K-wire position is achieved, make an approximate 1.5 cm incision at the projected Calcaneal Threaded Peg locations and perform blunt dissection to the bone. Adjust the Calcaneal Guide Construct to contact the posterior calcaneus.

Drill into the calcaneus with the provided $\varnothing 4.6$ mm Drill, checking termination point on lateral fluoroscopy. Threaded Peg length can be measured using the markings on the $\varnothing 4.6$ mm Drill while in the Calcaneal Guide Construct.

If measuring Calcaneal Threaded Peg depth from the Drill, round the measurement down to the nearest whole number.

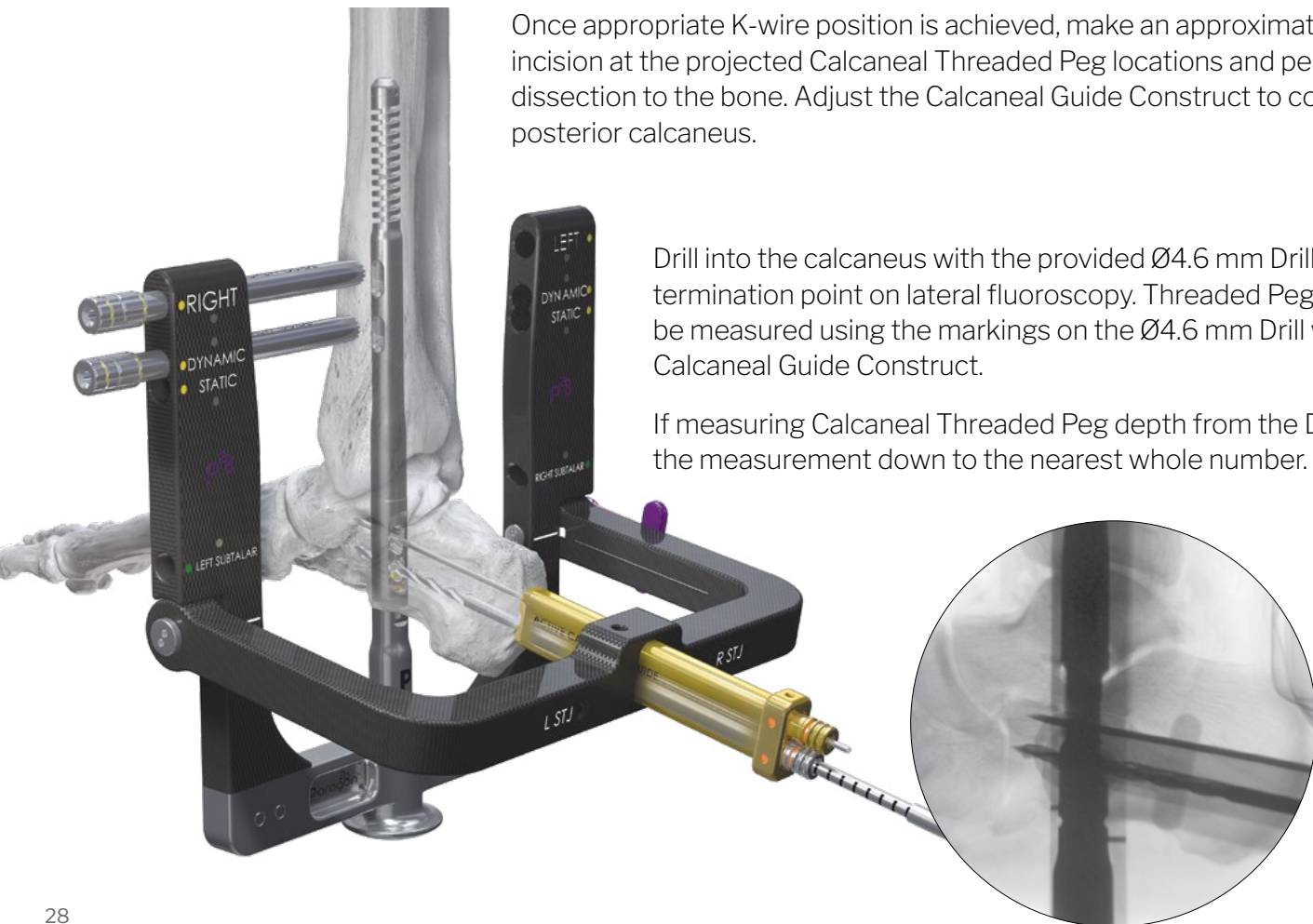

CALCANEAL THREADED PEG INSERTION



NOTE: Alternatively, Threaded Peg length can be measured by removing the Calcaneal Drill Guide from the Calcaneal Guide Construct. Insert the Solid Depth Gauge into the Calcaneal Guide Construct to measure Threaded Peg length.



Insert the inferior Calcaneal Threaded Peg using the provided TX-30 Driver. Insert the Threaded Peg until the black laser marked line on the Driver is flush with the Calcaneal Guide Construct. Verify inferior Calcaneal Threaded Peg length and placement under fluoroscopy.



NOTE: Ensure that the inferior Calcaneal Threaded Peg does not violate the calcaneocuboid joint on a dorsal-plantar fluoroscopy.



NOTE: To maintain parallel Calcaneal Threaded Peg trajectory, ensure that the Cam Lock is engaged and do not alter the position of the Calcaneal Guide Arm throughout the following sequence.

CALCANEAL THREADED PEG INSERTION

Remove the K-wire and K-wire Guide from the superior position of the Calcaneal Guide Construct. Insert the Drill Guide into the superior position and perform the previous steps to determine termination point and superior peg length. If measuring Calcaneal Threaded Peg depth from the Drill, round the measurement down to the nearest whole number. Insert the superior Calcaneal Threaded Peg using the provided TX-30 Driver.



TIP: Ensure the superior Calcaneal Threaded Peg respects the subtalar joint, this may mean additional bony purchase on the anterior aspect of the nail is not achieved.



NOTE: All Nail slots should be populated with Threaded Pegs as shown in this Surgical Technique Guide.

TIBIAL THREADED PEG INSERTION

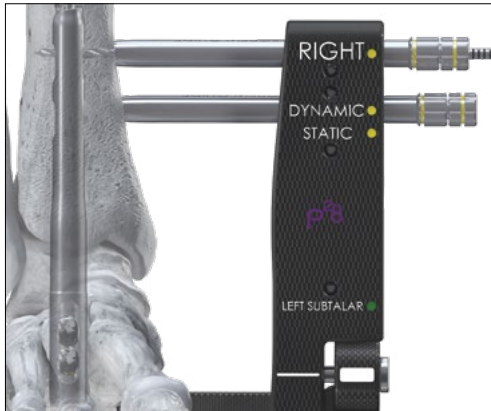

Ensure that the Tibial Drill Guides are positioned in the dynamic configuration to achieve constant compression. Do not place the Tibial Threaded Pegs in the static configuration. Make a small stab incision at the proximal Tibial Guide Construct. Perform blunt dissection and adjust Drill Guide Construct to abut bone. Drill bicortically, from the medial to lateral direction, through the Tibial Drill Guide using the Ø3.8 mm Drill.

Threaded Peg depth can be measured from the Drill with the Drill Guide in place and/or using the Solid Depth Gauge after removal of the Drill Guide. When measuring Tibial Threaded Peg depth, round the measurement up to the nearest whole number unless the termination point is within the incisure.



NOTE: If measuring Threaded Peg depth from the Drill, ensure that the Drill Guide is touching the bone and the drill tip is reaching the lateral edge. If measuring Threaded Peg depth off of the Solid Depth Gauge, ensure the Drill Guide is touching the bone and the Solid Depth Gauge is grabbing the lateral cortex.

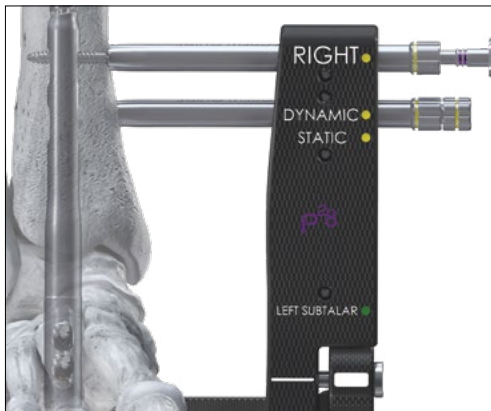

Once the Tibial Drill Guide is removed, insert the appropriately sized Threaded Peg through the Tibial Peg Guide and into the Nail using the long TX-20 Driver and handle, turning in a clockwise direction until the laser mark on the Driver meets the end of the Tibial Peg Guide, or when the head of the Threaded Peg is snug against the tibia.

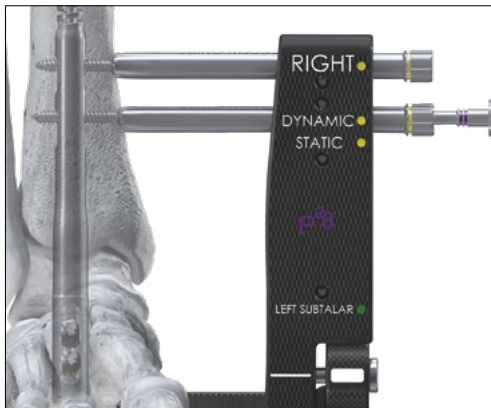

Verify the Threaded Peg length and placement under fluoroscopy. Repeat the steps above to place the second Tibial Threaded Peg in the dynamic slot.



NOTE: Ensure that the Tibial Threaded Pegs do not violate the fibula on fluoroscopy.

TIBIAL THREADED PEG INSERTION

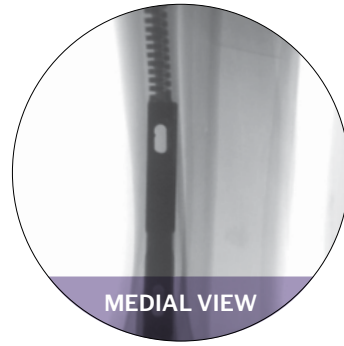
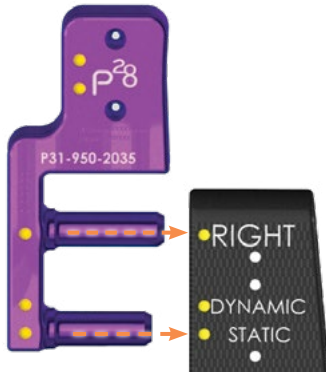

Without Tibial Guide Construct

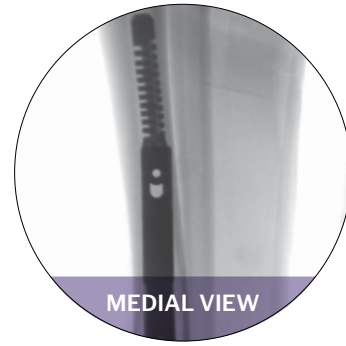

With Tibial Guide Construct



Phantom ActivCore™ Nails measuring 250 mm or greater in length provide a 3rd Tibial Threaded Peg hole. The Proximal Guide Arm is provided to insert the most proximal Tibial Threaded Peg. To attach, insert the Proximal Guide Arm into the most proximal medial tibial arm slot on the Outrigger.

Insert the Tibial Guide Construct into the Proximal Guide Arm, using either the dynamic or static configuration to achieve constant compression. Using a lateral fluoroscopic view, ensure that the Tibial Guide Construct is centered over the most proximal Nail slot.

Repeat the steps previously described to insert the Tibial Threaded Peg.

REMOVING THE TENSION SCREW



To remove the Tension Screw from the distal aspect of the Nail, swing the Calcaneal Guide Arm away from the strike plate. Insert the TX-30 Driver into the plantar portion of the Nail through the Outrigger.



Turn the Driver three turns counterclockwise to completely release the Tension Screw. If the Tension Screw is retained in the Outrigger, ensure that it is removed from the Outrigger and passed from the operative field. With removal of the Tension Screw from the Nail, the inner core is now activated.



NOTE: If the Outrigger was removed prior to releasing the Tension Screw, ensure the Tension Screw is removed from the ActivCore Nail and passed from the operative field.

OUTRIGGER REMOVAL

Verify Nail and Threaded Peg placement under multiple fluoroscopic views. Using the bolt Driver attachment and Handle, turn counterclockwise until the Outrigger is released from the Nail.

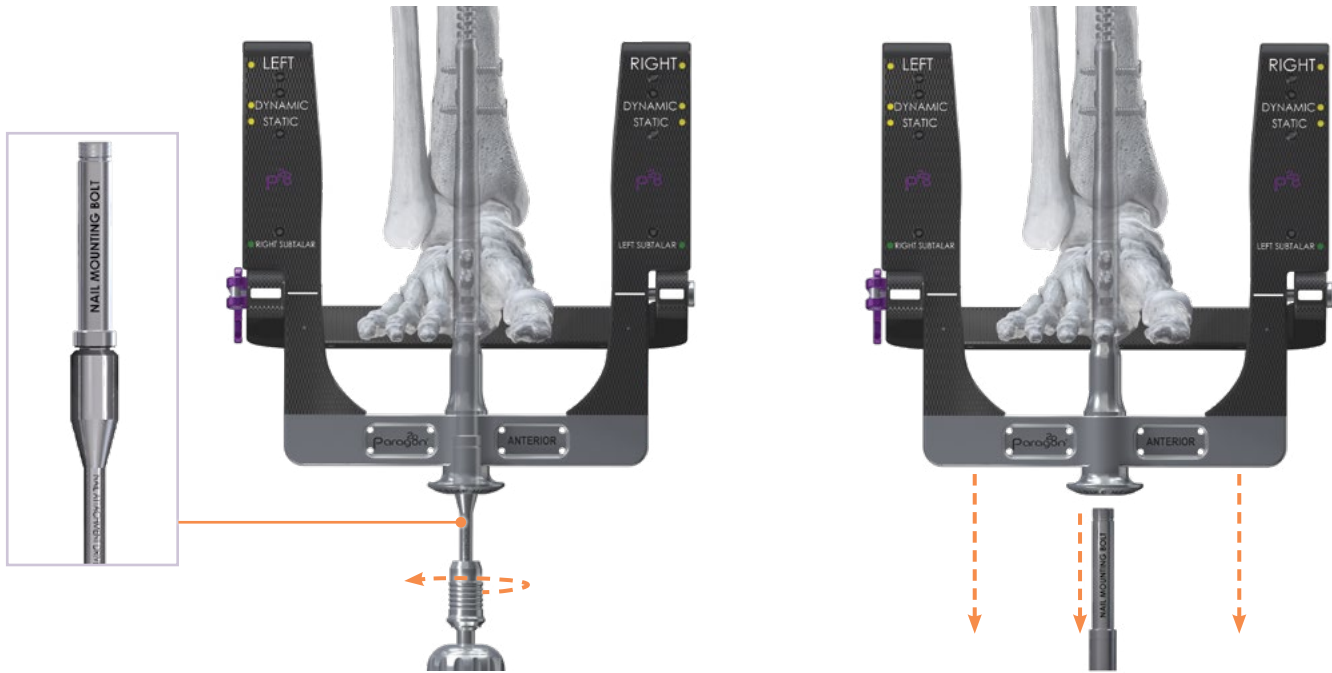

END CAP PLACEMENT

Secure the selected End Cap to the Nail using the short TX-30 Driver in a clockwise direction until the End Cap is secure.



NOTE: Alternatively, a Ø2.3 mm K-wire can be used as a guide into the distal part of the Nail, with the End Cap placed over the K-wire, to allow for centering of the End Cap prior to threading into position.

CLOSURE

Proceed to incision closure or concomitant procedures at this time.

IMPLANT REMOVAL

Attach the TX-30 Driver to the appropriate Handle. Using fluoroscopy, locate the plantar insertion point of the Nail, and make a small incision. If an end cap was implanted, insert the TX-30 Driver into the end cap and rotate counterclockwise to remove. If no end cap was implanted, proceed to the Explant Attachment and Slap Hammer step.

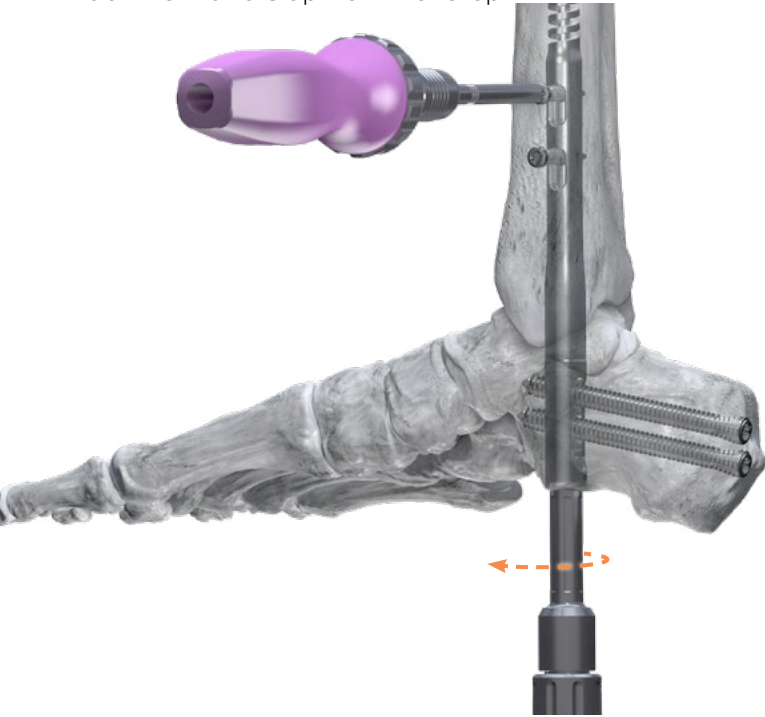

Attach the Explant Attachment onto the Slap Hammer to create the Slap Hammer Construct. Attach the Slap Hammer Construct to the Nail by rotating the Slap Hammer in a clockwise direction into the plantar portion of the Nail.

Using fluoroscopy, locate the Tibial Threaded Pegs. Make a small incision at each Threaded Peg location and insert the TX-20 Driver into the head of the Threaded Peg. Turn in a counterclockwise direction until each Threaded Peg is removed.

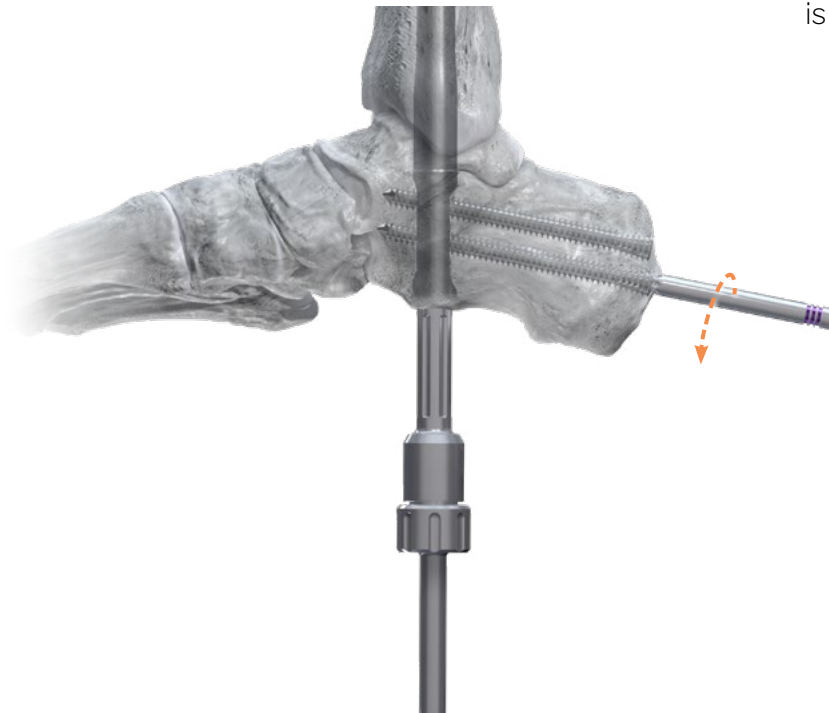

Utilizing the same TX-30 Driver and Handle construct as described above, remove the Calcaneal Threaded Pegs. Confirm removal of all Threaded Pegs, using fluoroscopy prior to attempting to remove the Phantom ActivCore™ Nail.

Use the sliding mechanism of the Slap Hammer to back the Nail out of the foot in an inferior direction until the Nail is removed.



PHANTOM® INSTRUMENT 1 (PHIN1)

The PRECISION® Guide, Parallel Offset Guide, Implant Sizer, Stepped Reamer, Entry Drill, Tissue Protectors, K-wires, and joint preparation instrumentation including Curettes, Osteotomes, Chisels, and a Honeybadger are located within PHIN1.

PHANTOM INSTRUMENT 2 (PHIN2)

The Reamer Heads, Flexible Reamer Shafts, Ball-Tipped Guide Rod, Ghost™ Outrigger, Drill Guides, Threaded Peg Guides, K-wire Guides, and a Hindfoot Distractor are located within PHIN2.

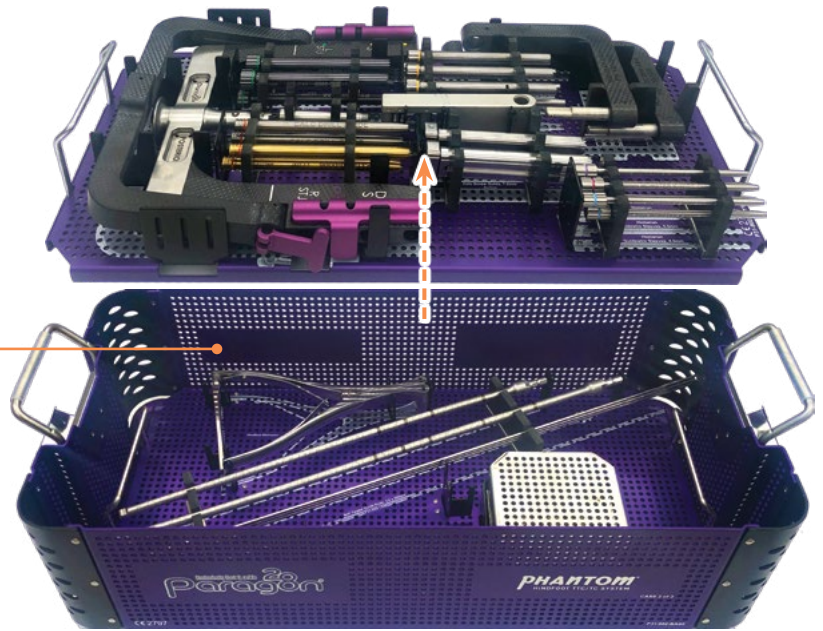

PHANTOM INSTRUMENT 3 (PHIN3)

The Threaded Pegs, End Caps, Drivers, Driver Attachments, Handles, Drills, Depth Gauges, Thor Hammer, Slap Hammer, and Explant Attachment are located within PHIN3.

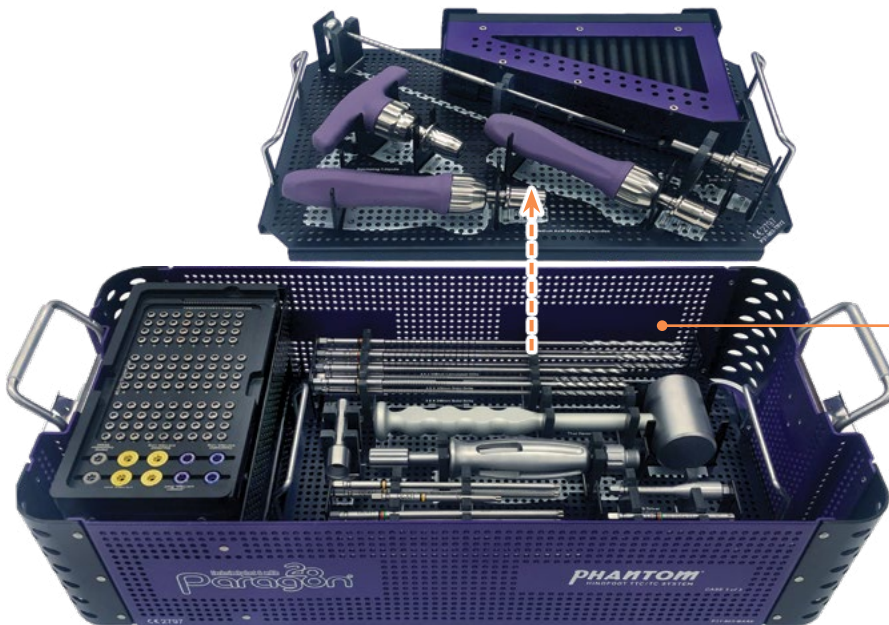

Refer to www.paragon28.com/ifus for the complete and most current instructions for use document.

INDICATIONS FOR USE

The Phantom® Small Bone Intramedullary Nail System is indicated for use in stabilization and fixation of the small bones of the feet and ankle for the treatment of fractures, osteotomies, arthrodesis, nonunions, pseudoarthroses and malunions caused by revision, joint fusion or reconstruction procedures.

CONTRAINDICATIONS

The Paragon 28® Phantom® Small Bone Intramedullary Nail System implants are not designed or sold for any use except as indicated. Use of the Phantom® Small Bone Intramedullary Nail System is contraindicated in the following situations:

- Active, suspected or latent infection in the affected area
- Patients who are physiologically or psychologically inadequate
- Patients previously sensitized to titanium
- Longitudinal splits or longitudinal fractures
- Insufficient quantity or quality of bone to permit stabilization, conditions that retard healing (not including pathological fractures) and conditions causing poor blood supply
- Open epiphyseal plates
- In patients where there is a possibility for conservative treatment
- Indications not included in the **INDICATIONS FOR USE**

POTENTIAL COMPLICATIONS AND ADVERSE REACTIONS

In any surgical procedure, the potential for complications and adverse reactions exist. The risks and complications with these implants include:

- Loosening, deformation or fracture of the implant
- Acute post-operative infections and late infections with possible sepsis
- Migration, subluxation of the implant with resulting reduction in range of movement
- Fractures resulting from unilateral joint loading
- Thrombosis and embolism
- Wound hematoma and delayed wound healing
- Temporary and protracted functional neurological perturbation
- Tissue reactions as a result of allergy or foreign body reaction to dislodged particles
- Corrosion with localized reaction and pain
- Pain, a feeling of malaise or abnormal sensations due to the implant used
- Bone loss due to stress shielding

All possible complications listed here are not typical of Paragon 28®, Inc. products but are in principle observed with any implant. Promptly inform Paragon 28®, Inc. as soon as complications occur in connection with the implants or surgical instruments used. In the event of premature failure of an implant in which a causal relationship with its geometry, surface quality or mechanical stability is suspected, please provide Paragon 28®, Inc. with the explant(s) in a cleaned, disinfected and sterile condition. Paragon 28®, Inc. cannot accept any other returns of used implants.

The surgeon is held liable for complications associated with inadequate asepsis, inadequate preparation of the osseous implant bed in the case of implants, incorrect indication or surgical technique or incorrect patient information and consequent incorrect patient behavior.

WARNINGS AND PRECAUTIONS

- Re-operation to remove or replace implants may be required at any time due to medical reasons or device failure. If corrective action is not taken, complications may occur.
- Use of an undersized implant in areas of high functional stresses may lead to implant fracture and failure.
- Plates and screws, wires, or other appliances of dissimilar metals should not be used together in or near the implant site.
- The implants and guide wires are intended for single use only.
- Instruments and K-wires are to be treated as sharps.
- **Do not use other manufacturer's instruments or implants in conjunction with the Phantom® Small Bone Intramedullary Nail System**

MR SAFETY INFORMATION

The Phantom® System has been evaluated for MR safety and compatibility in the MR environment. It has not been tested for heating, migration, or image artifact in the MR environment. The safety of the Phantom® Small Bone Intramedullary System in the MR environment is unknown. Scanning a patient who has this device may result in patient injury.

PHANTOM

ACTIVCORE™ NAIL SYSTEM

PATENTED, DESIGNED & EXCLUSIVELY DISTRIBUTED BY

Exclusively foot & ankle **28**
Paragon®

P31-STG-3002 RevC [06-10-2022]

™Trademarks and ®Registered Marks of Paragon 28®, Inc.

© Copyright 2022 Paragon 28®, Inc. All rights reserved.

Patents: www.paragon28.com/patents

Paragon 28, Inc. 🏢

14445 Grasslands Dr.

Englewood, CO 80112 USA

(855) 786-2828

Australian Sponsor

Emergo Australia

201 Sussex Street

Level 20, Tower II, Darling Park

Sydney, NSW 2000 Australia

DISCLAIMER

The purpose of the Phantom ActivCore™ Nail System Surgical Technique Guide is to demonstrate the optionality and functionality of the Phantom ActivCore™ Nail System. Although variations in placement and use of the Phantom ActivCore™ Nail System can be performed, the fixation options demonstrated in this technique were chosen to demonstrate the functionality of the system and for simplicity of explanation. Other uses for the Phantom ActivCore™ Nail System can be employed, appropriate for the size of the device. Federal law (U.S.A.) restricts this device to sale and use by, or on order of, a physician.

1. Internal Test Report TR-19121203
2. Whitten, "Evaluation of the Effects of Anodization on the Fatigue Performance of Titanium Alloy," in Fatigue and Fracture Metallic Medical Materials and Devices, ed. M. Mitchell, S. Smith, T. Woods, and B. Berg (West Conshohocken, PA: ASTM International, 2013), 109-121.
3. Internal Test Report TR-20031301
4. Papa JA, et al. Pantalar and tibiototalcaneal arthrodesis for the post-traumatic osteoarthrosis of the ankle and hindfoot. J Bone Joint Surg Am. 1992; 74: 1042-1049.
5. Internal Test Report TR-20060102

www.Paragon28.com