

SURGICAL TECHNIQUE GUIDE

Monster® and Mini-Monster® Screws



Exclusively foot & ankle
Paragon[®]

Acknowledgment:

Paragon 28° would like to thank Thomas San Giovanni, MD for his contribution to the surgical technique guide.

PRODUCT DESCRIPTION

The Paragon 28° Monster® Screw System objectives were set to produce a cannulated screw system that is comprehensive, high quality and specifically designed for the unique anatomy of the foot and ankle.

The Paragon 28° Monster® Screw System offers three different screw diameters in one set. The Paragon 28° Mini-Monster® Screw System offers five smaller cannulated screw options than the Monster® Screw System. With 8 different screw diameters, multiple thread length options and headed and headless varieties in all diameters, the Monster® and Mini-Monster® Screw Systems provide a degree of versatility that allows for fixation of osteotomies, fractures, and joint arthrodesis in the forefoot, midfoot, hindfoot, and ankle.

CONTENTS

Section 1	MONSTER® AND MINI-MONSTER® SCREWS
	UNIQUE DESIGN FEATURES..... 3-4
	SCREW OPTIONALITY 5
	MONSTER® AND MINI-MONSTER® SCREW INSTRUMENTATION..... 7-8
	MONSTER SCREW SYSTEM INSTRUMENTATION 9-10
Section 2	MONSTER® AND MINI-MONSTER® TECHNIQUES
	PARTIALLY THREADED HEADED SCREW INSERTION.....11
	PARTIALLY THREADED HEADLESS SCREW INSERTION 12
	FULLY THREADED SCREW INSERTION 13
	FULLY THREADED SCREW INSERTION WITH COMPRESSION..... 14
Section 3	
	CADDY SYSTEM 15-17
	INDICATIONS, CONTRAINDICATIONS, WARNINGS..... 18-19

UNIQUE DESIGN FEATURES

The Monster[®] and Mini-Monster[®] Screws were made with a purpose:

- To deliver a product specifically designed for the foot and ankle surgeon's needs - a combination of screw types, diameters, and lengths to provide remarkable versatility.
- To offer flexibility to surgeons to change the type of screw used intraoperatively between headless and headed as well as partially threaded and fully threaded.
- To provide quality instrumentation for screw placement and insertion including Hintermann retractors, a Parallel K-wire Guide, and a 3 fluted Drill. The 3 fluted Drill provided for each screw diameter is designed to remove material in a manner to minimize crumbling without compression of bone prior to screw insertion.

Headed Screw:

Screw Head:

Rounded for decreased soft tissue irritation when the screw is inserted at an angle. The head diameter was optimized to help prevent plunging of the screw head into softer bone.

Screw Neck:

Reinforced screw neck geometry helps to prevent stress risers at a traditional weak point of the screw.



Headless Screw:

Screw Neck:

Headless screw design provides a tapered neck which helps enable controlled pre-compression before proximal thread engagement. The pitch ratio and taper were designed to not exceed (for a given size) the distal thread purchase while achieving compression.

Dual Pitch Threads:

A larger pitch differential (between proximal and distal threads) may contribute to early compression and resultant stripping of the distal threads during final screw insertion.

The neck of the screw was designed with a "Pre-Compression Taper" to help provide controlled compression. The proximal threads are designed to then "lock" in that compression rather than acting as the source of compression, thereby intending to not exceed what the distal thread purchase can tolerate.



UNIQUE DESIGN FEATURES

Hexalobe Driver:

Screw design allows for the largest possible hexalobe driver to be used to provide insertion torque without compromising strength.



Forward Cutting Flutes for Headed and Headless Screws:

Allow for the screw to be self-tapping. The "flat" at each flute helps to cut into the bone and create a thread pattern during screw insertion.

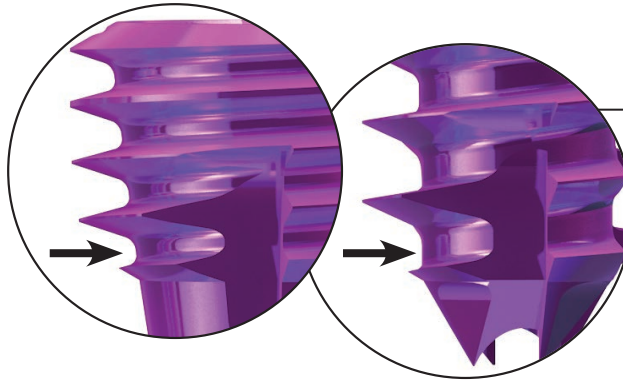

Sharp Threads:

Screw threads taper to a size of .02 mm (.0008") at the crest, allowing for improved definition between the thread and bone interface and increasing the surface area contact, allowing for better "bite" in soft or weaker bone.

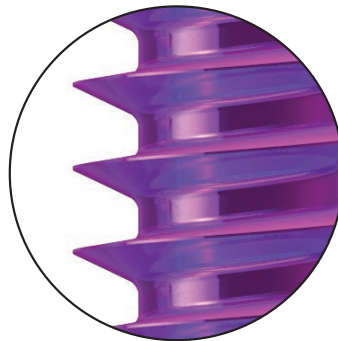

Reverse Cutting Flutes:

Self-tapping reverse threads help facilitate screw removal.

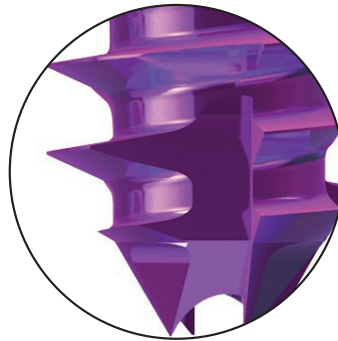

Sharp Tip:

The 4 sharp tips are self-drilling and self-tapping to allow for bone to escape along the backside of the tip and allow for less torque upon insertion.

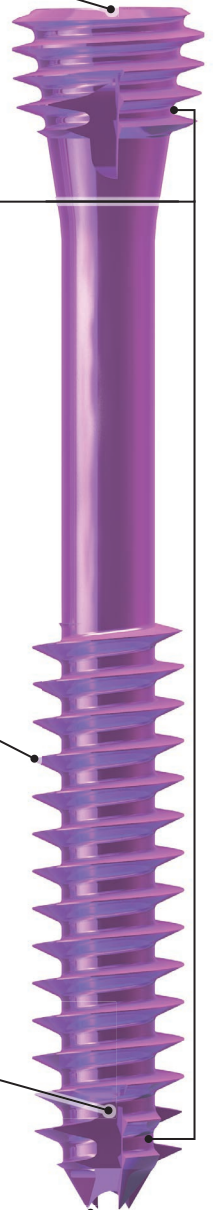
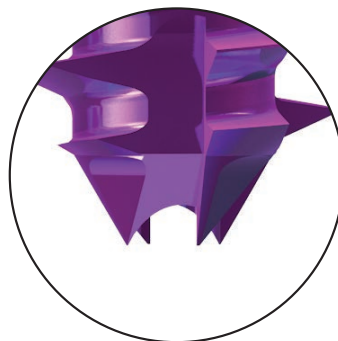

SCREW OPTIONALITY - MINI-MONSTER SCREWS

Ø2.0 mm Screws	Headed:		Headless:	
Headed:				
Threads Offerings:	Fully Threaded	Partially Threaded	Partially Threaded: Long	Partially Threaded: Short
Screw Lengths:	8-20 mm 1 mm increments 22-50 mm 2 mm increments		30-50 mm 2 mm increments	10-20 mm 1 mm increments 22-50 mm 2 mm increments





Ø2.5 mm Screws	Headed:		Headless:	
Headed:				
Threads Offerings:	Fully Threaded	Partially Threaded	Partially Threaded: Long	Partially Threaded: Short
Screw Lengths:	10-20 mm 1 mm increments 22-50 mm 2 mm increments		30-50 mm 2 mm increments	10-20 mm 1 mm increments 22-50 mm 2 mm increments





Ø3.0 mm Screws	Headed:		Headless:
Headed:			
Threads Offerings:	Fully Threaded	Partially Threaded	Partially Threaded Short
Screw Lengths:	10-50 mm 2 mm increments		





Ø3.5 mm Screws	Headed:		Headless:
Headed:			
Threads Offerings:	Fully Threaded	Partially Threaded	Partially Threaded Short
Screw Lengths:	10-50 mm 2 mm increments		12-50 mm 2 mm increments

Ø4.0 mm Screws	Headed:			Headless:	
Headed:					
Threads Offerings:	Fully Threaded	Partially Threaded: Long	Partially Threaded: Short	Partially Threaded: Long	Partially Threaded: Short
Screw Lengths:	12-50 mm 2 mm increments 55-60 mm 5 mm increments	28-50 mm 2 mm increments 55-60 mm 5 mm increments	12-50 mm 2 mm increments 55-60 mm 5 mm increments	28-50 mm 2 mm increments 55-60 mm 5 mm increments	14-50 mm 2 mm increments 55-60 mm 5 mm increments

SCREW OPTIONALITY - MONSTER SCREWS

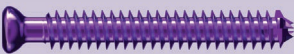
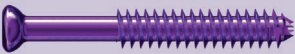
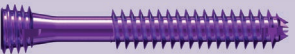
Ø4.5 mm Screws	Headed:		Headless:	
				
Threads Offerings:	Fully Threaded	Partially Threaded: Long	Partially Threaded: Long	Partially Threaded: Short
Screw Lengths:	18-50 mm 2 mm increments 55-70 mm 5 mm increments	20 - 50 mm 2 mm increments 55- 70 mm 5 mm increments	30-50 mm 2 mm increments 55-70 mm 5 mm increments	18-50 mm 2 mm increments 55-70 mm 5 mm increments
				
Threads Offerings:	Partially Threaded: Short			
Screw Lengths:	18-50 mm 2 mm increments 55-70 mm 5 mm increments			

Ø5.5 mm Screws	Headed:		Headless:	
				
Threads Offerings:	Fully Threaded	Partially Threaded: Long	Partially Threaded: Long	Partially Threaded: Short
Screw Lengths:	26-60 mm 2 mm increments 65-90 mm 5 mm increments	40-60 mm 2 mm increments 65-90 mm 5 mm increments	40-60 mm 2 mm increments 65-90 mm 5 mm increments	26-60 mm 2 mm increments 65-90 mm 5 mm increments
				
Threads Offerings:	Partially Threaded: Short			
Screw Lengths:	26-60 mm 2 mm increments 65-90 mm 5 mm increments			

Ø7.0 mm Screws	Headed:		Headless:	
				
Threads Offerings:	Fully Threaded	Partially Threaded: Long	Partially Threaded: Long	Partially Threaded: Medium
Screw Lengths:	36-50 mm and 72-90 mm 2 mm increments 55-70 mm and 95-130 mm 5 mm increments	44-50 mm and 72-90 mm 2 mm increments 55-70 mm and 95-130 mm 5 mm increments	72-90 mm 2 mm increments 60-70 mm and 95-130 mm 5 mm increments	44-50 mm and 72-90 mm 2 mm increments 55-70 mm and 95-130 mm 5 mm increments
				
Threads Offerings:	Partially Threaded: Medium	Partially Threaded: Short	Partially Threaded: Short	
Screw Lengths:	40-50 mm and 72-90 mm 2 mm increments 55-70 mm and 95-130 mm 5 mm increments	36-50 mm and 72-90 mm 2 mm increments 55-70 mm and 95-130 mm 5 mm increments	36-50 mm and 72-90 mm 2 mm increments 55-70 mm and 95-130 mm 5 mm increments	

MONSTER AND MINI-MONSTER SCREW INSTRUMENTATION

The chart below demonstrates screw sizes with their color coded corresponding instrumentation.

Screws:	Ø2.0 mm	Ø2.5 mm	Ø3.0 mm	Ø3.5 mm	Ø4.0 mm	Ø4.5 mm	Ø5.5 mm	Ø7.0 mm
K-wire Size:	 Ø0.9 mm	 Ø0.9 mm	 Ø1.1 mm	 Ø1.2 mm	 Ø1.2 mm	 Ø1.4 mm	 Ø1.6 mm	 Ø2.3 mm
Drill Size:	 Ø1.7 mm	 Ø1.7 mm	 Ø2.1 mm	 Ø2.3 mm	 Ø2.6 mm	 Ø2.9 mm	 Ø3.5 mm	 Ø4.6 mm
Drill Guide Size:	 Ø2.0/Ø2.5 mm	 Ø2.0/Ø2.5 mm	 Ø3.0 mm	 Ø3.5 mm	 Ø4.0 mm	 Ø4.5 mm	 Ø5.5 mm	 Ø7.0 mm
Overdrill Size:	 Ø2.0 mm	 Ø2.5 mm	 Ø3.0 mm	 Ø3.5 mm	 Ø4.0 mm	 Ø4.5 mm	 Ø5.5 mm	 Ø7.0 mm
Overdrill Guide Size:	 Ø2.0 mm	 Ø2.5 mm	 Ø3.0 mm	 Ø3.5 mm	 Ø4.0 mm	Not Available	Not Available	Not Available
Tap Size:	Not Available	 Ø2.5 mm	 Ø3.0 mm	 Ø3.5 mm	 Ø4.0 mm	 Ø4.5 mm	 Ø5.5 mm	 Ø7.0 mm
Countersink Size:	 Ø2.0 mm	 Ø2.5 mm	 Ø3.0 mm	 Ø3.5 mm	 Ø4.0 mm	 Ø4.5 mm	 Ø5.5 mm	 Ø7.0 mm

Handles		Screw Length Use:	Solid or Cannulated
AO Handle:		The AO Handle is for use with the Mini-Monster® Screws from Ø2.0 mm - Ø4.0 mm	Both
Streamline AO Handle:		The Streamline AO Handle is for use with the Mini-Monster® Screws from Ø2.0 mm - Ø4.0 mm	Both
3/16" AO Handle:		The 3/16" AO Handle is for use with the Monster® Screws from Ø4.5 mm - Ø7.0 mm.	Both



Note: A solid driver is provided in addition to the cannulated driver for the Ø2.0 mm and Ø2.5 mm screws. It is to be used when performing final screw insertion and tightening.

MONSTER AND MINI-MONSTER SCREW INSTRUMENTATION

The instruments depicted below are specific for each screw diameter within the Monster and Mini-Monster systems. The instruments shown are for the Ø4.0 mm Mini-Monster screw size as an example. All Monster and Mini-Monster instrumentation have colored band/markings that correspond to the screw size.

K-wires



Headed Screw Countersink



Headless Screw Countersink

Depth Gauge



Drill

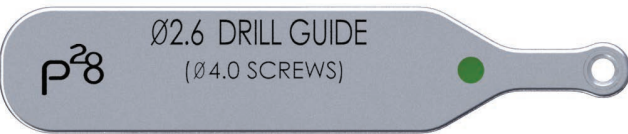

Drill Guide

Overdrill

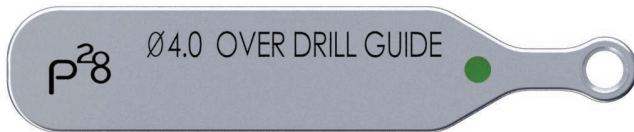

Overdrill Guide

Tap



Driver

MONSTER SCREW SYSTEM INSTRUMENTATION



Parallel K-wire Guide

Assists in spacing and positioning of K-wires for Ø7.0 mm Monster Screws, to allow for a second K-wire to be placed parallel to the initial K-wire. An indicator is also present to allow for appropriate spacing between two K-wires, such that two Ø7.0 mm Monster Screws can be placed without screw head collision.

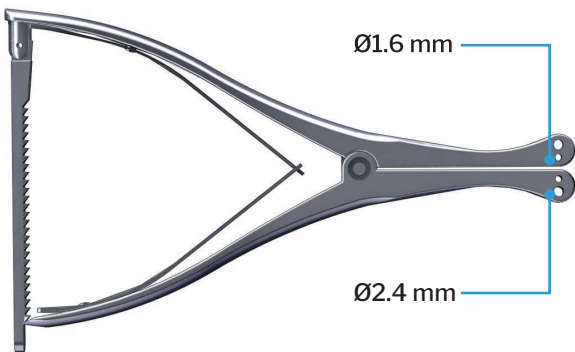

Hintermann Retractor

The larger, outside holes accommodates Ø2.3 mm K-wires but can alternatively be used with a Steinmann Pin up to Ø2.4 mm. The smaller, inner hole accommodates up to Ø1.6 mm K-wires.



3/16" Jacob's Adaptor

Available for the Ø4.5 mm, Ø5.5 mm, and Ø7.0 mm Monster Screw sizes.



Cleaning Stylet:

Monster Screw Washer Options:

- Bowl Washer allows for the washer to be seated in the countersunk portion of the bone.
- Split-Flat and Bowl-Slot Washers allow for placement of a washer after screw insertion without the need to back the screw out.

Washer Options:	Deep -Well	Flat	Domed	Bowl	Split-Flat	Bowl-Slot
Shape:						
Sizes Offered:	Ø2.0 mm Ø2.5 mm Ø3.0 mm Ø3.5 mm Ø4.0 mm	Ø4.5 mm Ø5.5 mm Ø7.0 mm	Ø4.5 mm Ø5.5 mm Ø7.0 mm	Ø7.0 mm	Ø7.0 mm	Ø7.0 mm

FluoroBand™ Guide Wires:

- The Monster Screw thread length is determined by which Fluoroband is at or crossing the arthrodesis, osteotomy or fracture site.
 - If the 1st FluoroBand™ is not across the site, then use a short thread length screw.
 - If the 1st FluoroBand™ is across the site but not 2nd FluoroBand™, use either a short or medium thread length screw.
 - If the 2nd FluoroBand™ is across the site then use the long thread length screw.
 - Available in smooth and threaded options.

2nd Fluoroband™ is located 32 mm from the tip of the wire

1st Fluoroband™ is located 20 mm from the tip of the wire



MONSTER SCREW SYSTEM INSTRUMENTATION



Note: The instruments listed below are contained only in the Monster Screw System Midfoot/Hindfoot Set. (4.5 mm, 5.5 mm, and 7.0 mm screw diameters).

2-in-1 Tissue Protector

A K-wire guide (A) is available for the Monster Screw Systems that inserts into the drill guide (B) for the screw size selected. With the K-wire guide inserted into the drill guide, the K-wire can be driven into bone with soft tissue protection. (C) Both smooth and threaded K-wires are available in the Monster Screw System Case.

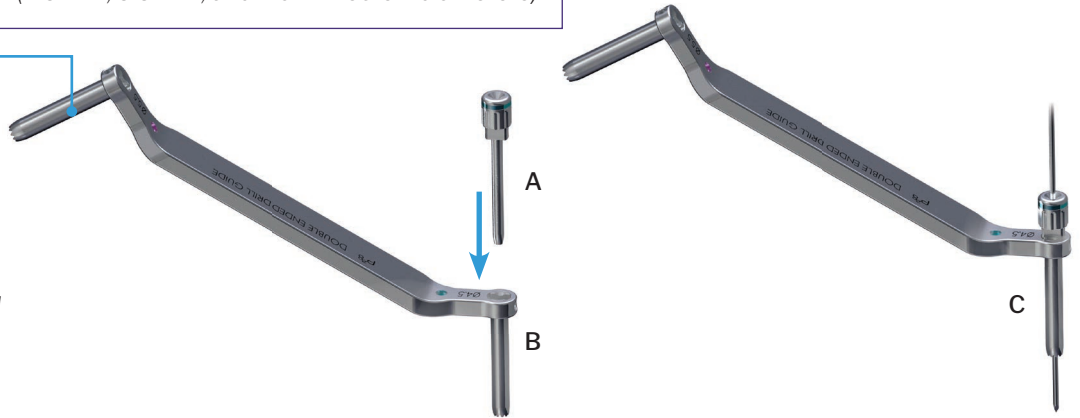

Note: The instruments below are specific to the Monster Ø7.0 mm Screws.

3-In-1 Tissue Protector

Available for minimally invasive insertion of a Ø7.0 mm screw. The assembly contains: K-wire Guide (A), Drill Guide (B), and Tissue Protector (C), which can be pre-assembled (D).

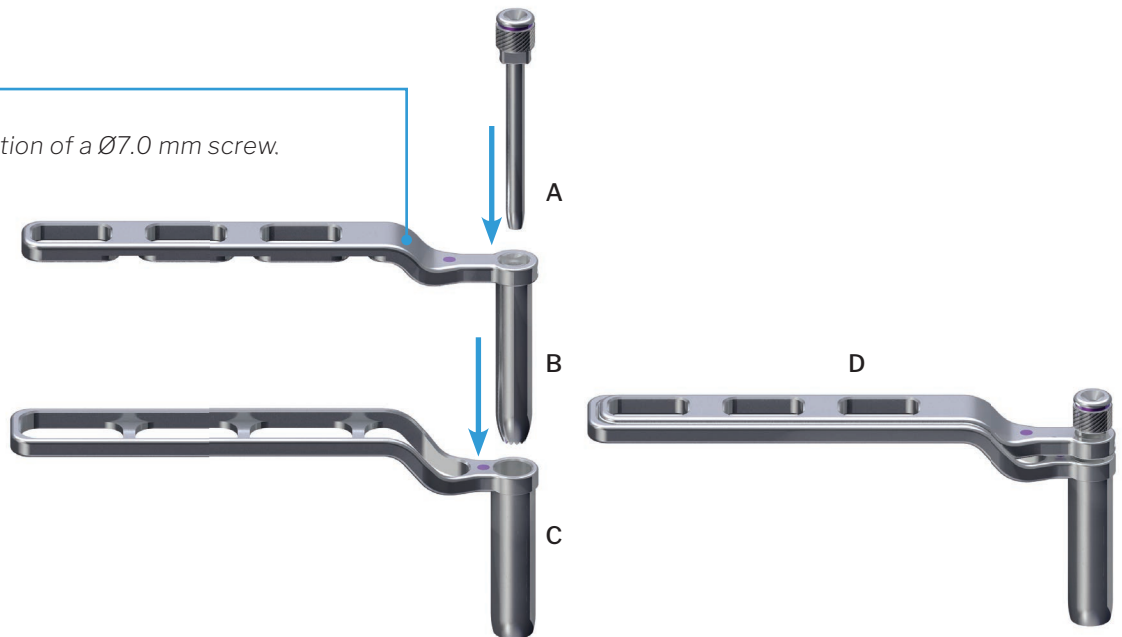

Countersinks with Stops

The Countersink with a stop is specific to the Ø7.0 mm screw size prevents accidental overaggressive countersinking by only penetrating to the appropriate depth.

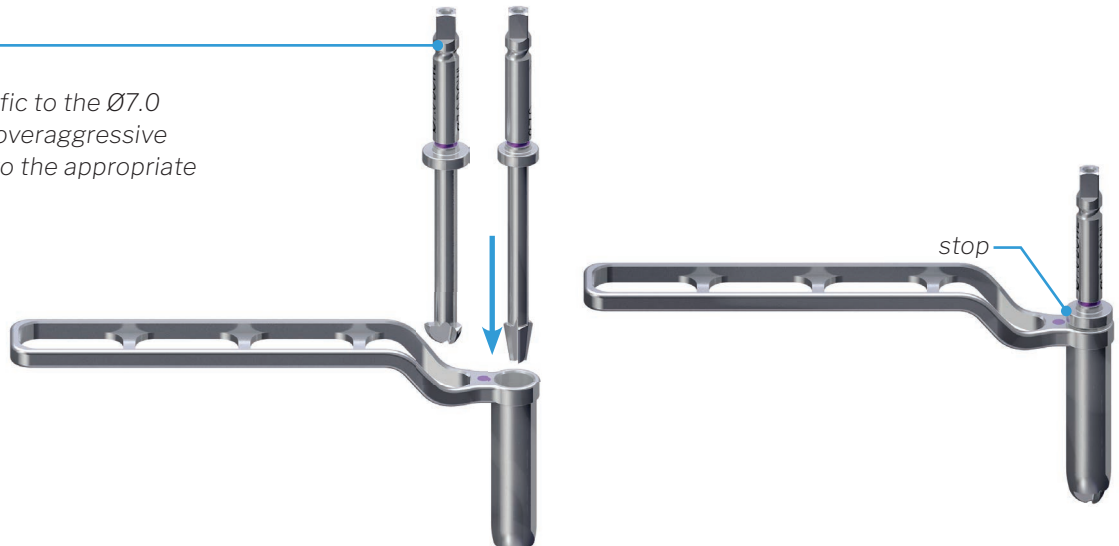

PARTIALLY THREADED HEADED SCREW INSERTION



Note: The use of a Ø4.0 mm screw is demonstrated, however the steps below are applicable to all screw sizes. Refer to the table on page 7 for the proper instrumentation that corresponds to the desired screw diameter.

K-wire:

Insert a Ø1.2 mm K-wire across the arthrodesis, fracture, or osteotomy site. Confirm trajectory using fluoroscopy. A K-wire Guide is available for the Monster Screw System (Ø4.5 mm, Ø5.5mm, and Ø7.0 mm).

Countersink:

Retrieve the Ø4.0 mm Countersink for the Ø4.0 mm Mini-Monster Screw, and attach to the appropriate driver. Rotate the Countersink clockwise over the K-wire to remove adequate bone to seat the screw.

Measure:

Measure for screw length using the Depth Gauge.

Drill:

Drill over the K-wire using the Ø2.6 mm Drill for the Ø4.0 mm Mini-Monster Screw. The Cannulated Drill may be used to measure for screw length when it is used in conjunction with a Drill Guide. For Headed screws the estimated head height must be subtracted from the length drilled.

Optional Tap:

Taps are provided to be used in situations where hard bone is encountered, or resistance to screw insertion occurs. Attach the tap to the appropriate sized handle and hand tap.

Screw Insertion:

Attach the appropriate driver to the corresponding handle. Insert a Ø4.0 mm Mini-Monster screw by turning the Driver in a clockwise manner. Confirm screw length and position using fluroscopy. Remove the Ø1.2 mm K-wire at this time.

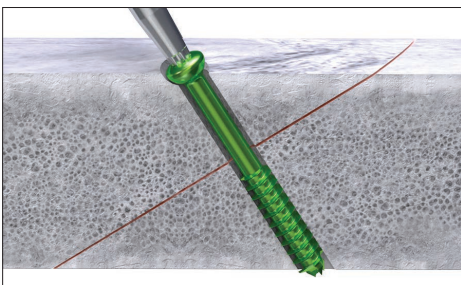
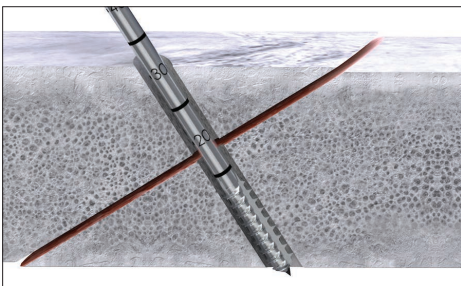
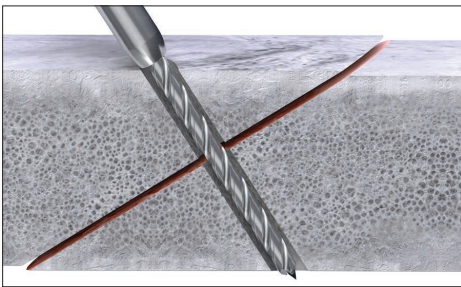
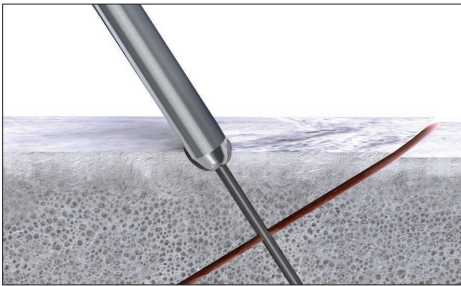
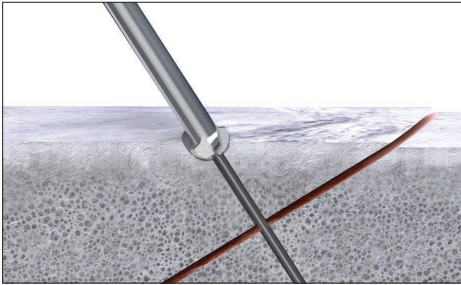
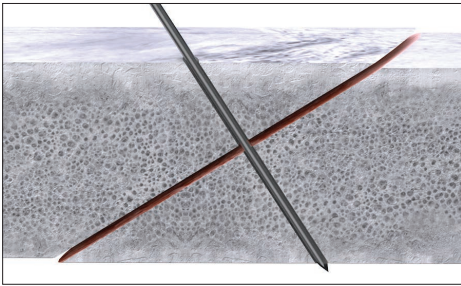

PARTIALLY THREADED HEADLESS SCREW INSERTION

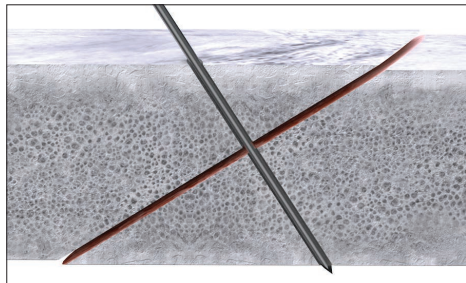

K-wire:

Insert a Ø1.2 mm K-wire across the arthrodesis, fracture, or osteotomy site. Confirm trajectory using fluoroscopy. A K-wire Guide is available for the Monster Screw System (Ø4.5 mm, Ø5.5mm, and Ø7.0 mm).

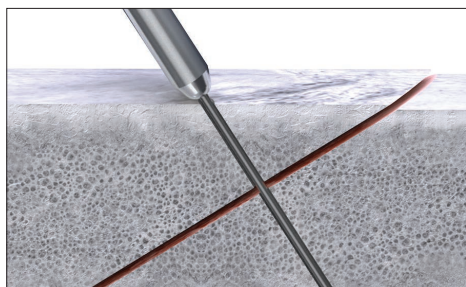

Measure:

Measure for screw length using the Depth Gauge.

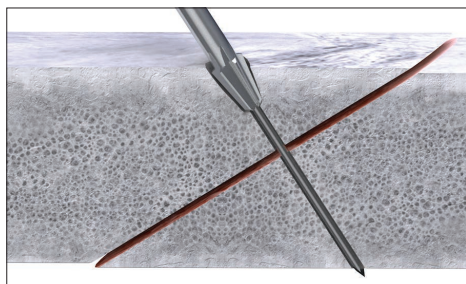

Countersink:

Retrieve the Ø4.0 mm Countersink for the Ø4.0 mm Mini-Monster Screw, and attach to the appropriate driver. Rotate the Countersink clockwise over the K-wire to remove adequate bone to seat the screw.

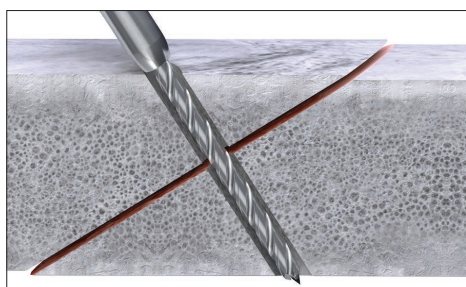

Drill:

Drill over the K-wire using the Ø2.6 mm Drill for the Ø4.0 mm Mini-Monster Screw. For Headless screws, the Cannulated Drill may be used to directly measure for screw length.

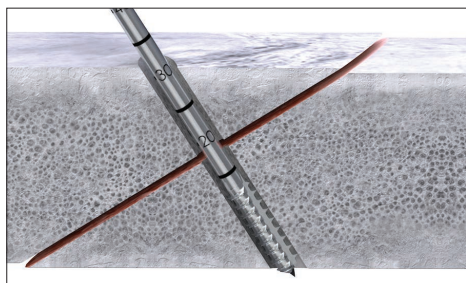

Optional Tap:

Taps are provided to be used in situations where hard bone is encountered, or resistance to screw insertion occurs. Attach the tap to the appropriate sized handle and hand tap.

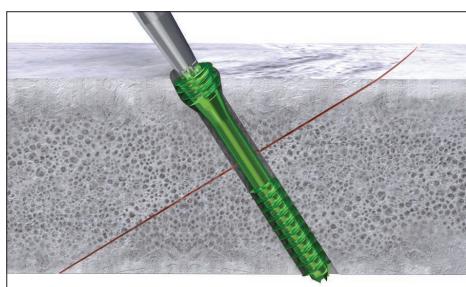

Screw Insertion:

Attach the appropriate driver to the corresponding handle. Insert a Ø4.0 mm Mini-Monster screw by turning the Driver in a clockwise manner. Confirm screw length and position using fluroscopy. Remove the Ø1.2 mm K-wire at this time.

FULLY THREADED SCREW INSERTION

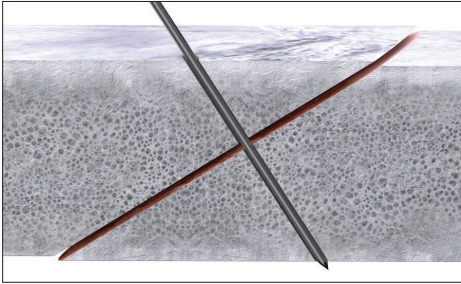

K-wire:

Insert a Ø1.2 mm K-wire across the arthrodesis, fracture, or osteotomy site. Confirm trajectory using fluoroscopy. A K-wire Guide is available for the Monster Screw System (Ø4.5 mm, Ø5.5mm, and Ø7.0 mm).

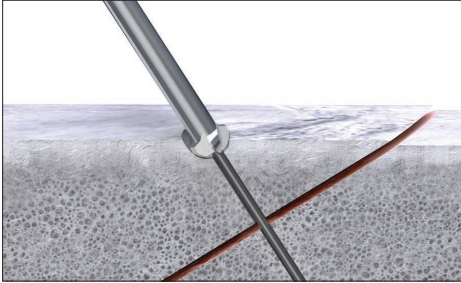

Countersink:

Retrieve the Ø4.0 mm Countersink for the Ø4.0 mm Mini-Monster Screw, and attach to the appropriate driver. Rotate the Countersink clockwise over the K-wire to remove adequate bone to seat the screw.

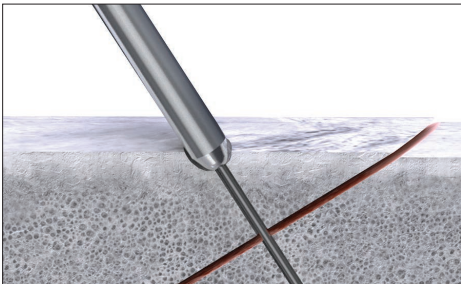

Measure:

Measure for screw length using the Depth Gauge.

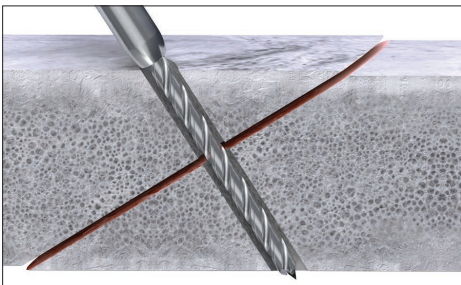

Drill:

Drill over the K-wire using the Ø2.6 mm Drill for the Ø4.0 mm Mini-Monster Screw. The Cannulated Drill may be used to measure for screw length when it is used in conjunction with a Drill Guide. For Headed screws the estimated head height must be subtracted from the length drilled.

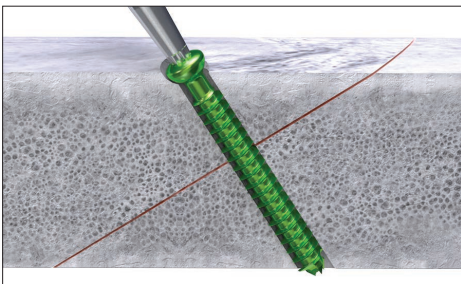

Screw Insertion:

Attach the appropriate driver to the corresponding handle. Insert a Ø4.0 mm Mini-Monster screw by turning the Driver in a clockwise manner. Confirm screw length and position using fluroscopy. Remove the Ø1.2 mm K-wire at this time.

FULLY THREADED SCREW INSERTION WITH COMPRESSION

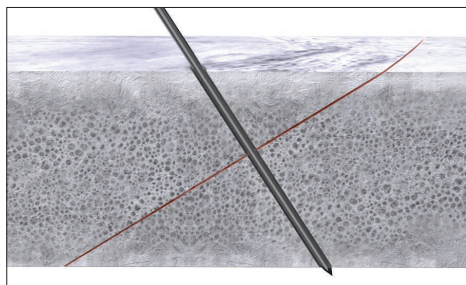

K-wire:

Insert a Ø1.2 mm K-wire across the arthrodesis, fracture, or osteotomy site. Confirm trajectory using fluoroscopy. A K-wire Guide is available for the Monster Screw System (Ø4.5 mm, Ø5.5mm, and Ø7.0 mm).

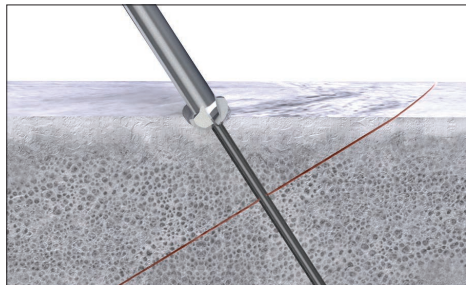

Countersink:

Retrieve the Ø4.0 mm Countersink for the Ø4.0 mm Mini-Monster Screw, and attach to the appropriate driver. Rotate the Countersink clockwise over the K-wire to remove adequate bone to seat the screw.

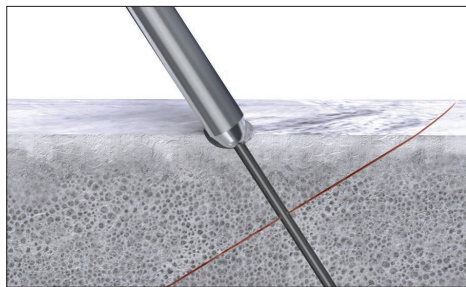

Measure:

Measure for screw length using the Depth Gauge.

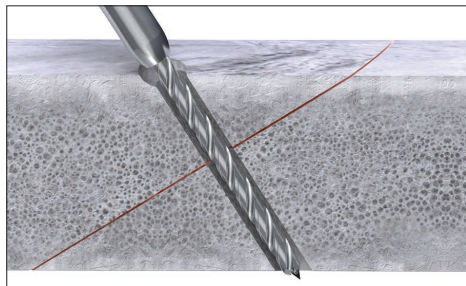

Drill:

Drill over the K-wire using the Ø2.6 mm Drill for the Ø4.0 mm Mini-Monster Screw. The Cannulated Drill may be used to measure for screw length when it is used in conjunction with a Drill Guide. For Headed screws the estimated head height must be subtracted from the length drilled.

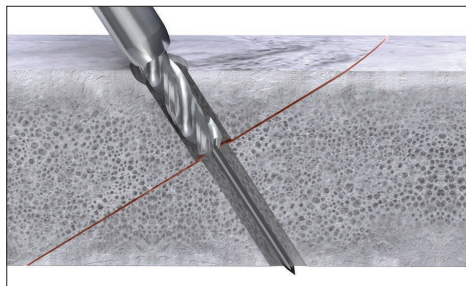

Overdrill:

Overdrill Guides are provided for the Monster and Mini-Monster screw sets, and is sized to fit the screw outer diameter and the Overdrill. The colored dot on the top of the Overdrill Guide corresponds to the screw color.

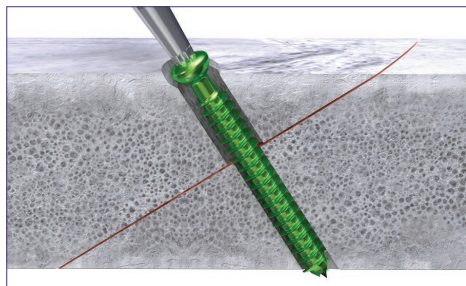

Screw Insertion:

Attach the appropriate driver to the corresponding handle. Insert a Ø4.0 mm Mini-Monster screw by turning the Driver in a clockwise manner. Confirm screw length and position using fluroscopy. Remove the Ø1.2 mm K-wire at this time.

THE MONSTER[®] SCREW SYSTEM CADDY

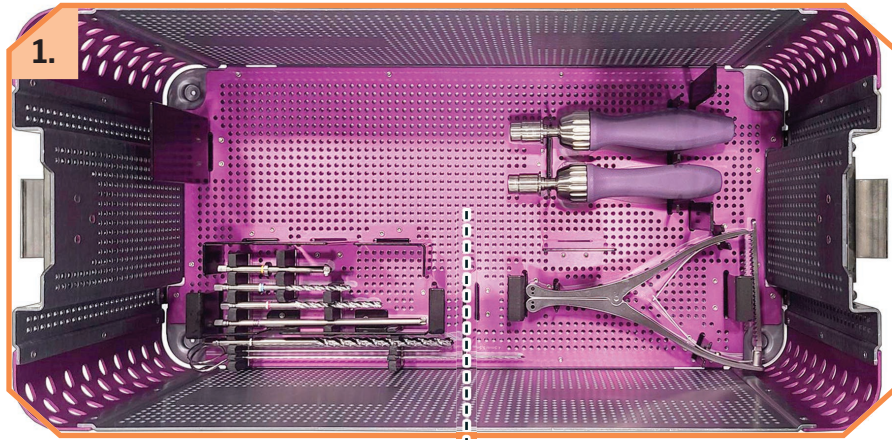

1. MONSTER[®] CASE

The Hintermann Retractor, Ø7.0 Countersink, Bowl Washer, Overdrills (square connection Ø4.5 mm, Ø5.5 mm, Ø7.0mm), TX-30 Driver 3/16" connection, Cleaning Stylet (1.4 mm and 2.3 mm) and the large and small 3/16" sq Ratcheting Handles are all located in the bottom of the case.

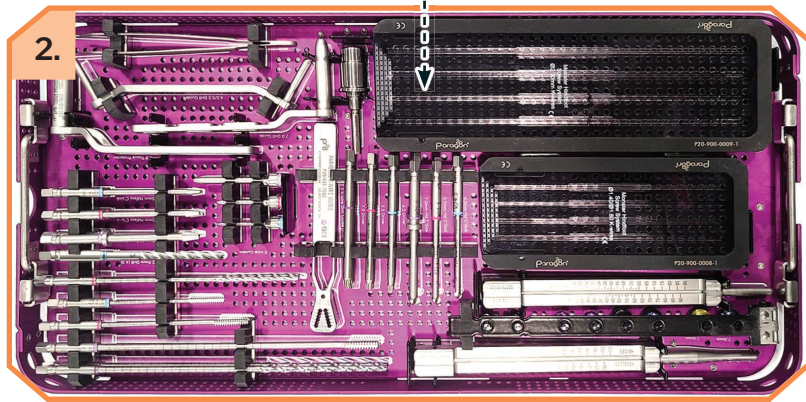

2. MONSTER[®] INSTRUMENT TRAY

The tray that sits atop the screw caddies contains two bins for K-wires: the longer bin containing the Guide Wires and FluoroBand™ Guide Wires for Ø7.0 mm screws and the shorter bin containing the Guide Wires for the Ø4.5 mm and Ø5.5 mm screws. Also contained in this tray are Countersinks, Washers, Drivers, Drill Guides, Taps, Depth Gauges, the Parallel K-wire Guide, the 3/16" Jacobs Adapter, and the 3-In-1 Tissue Protector for the Ø7.0 mm screws.

3a-3c. MONSTER[®] SCREW SYSTEM CADDY

The Monster[®] Screw System Midfoot/Hindfoot Set contains the caddies for Ø4.5 mm, Ø5.5 mm, and Ø7.0 mm

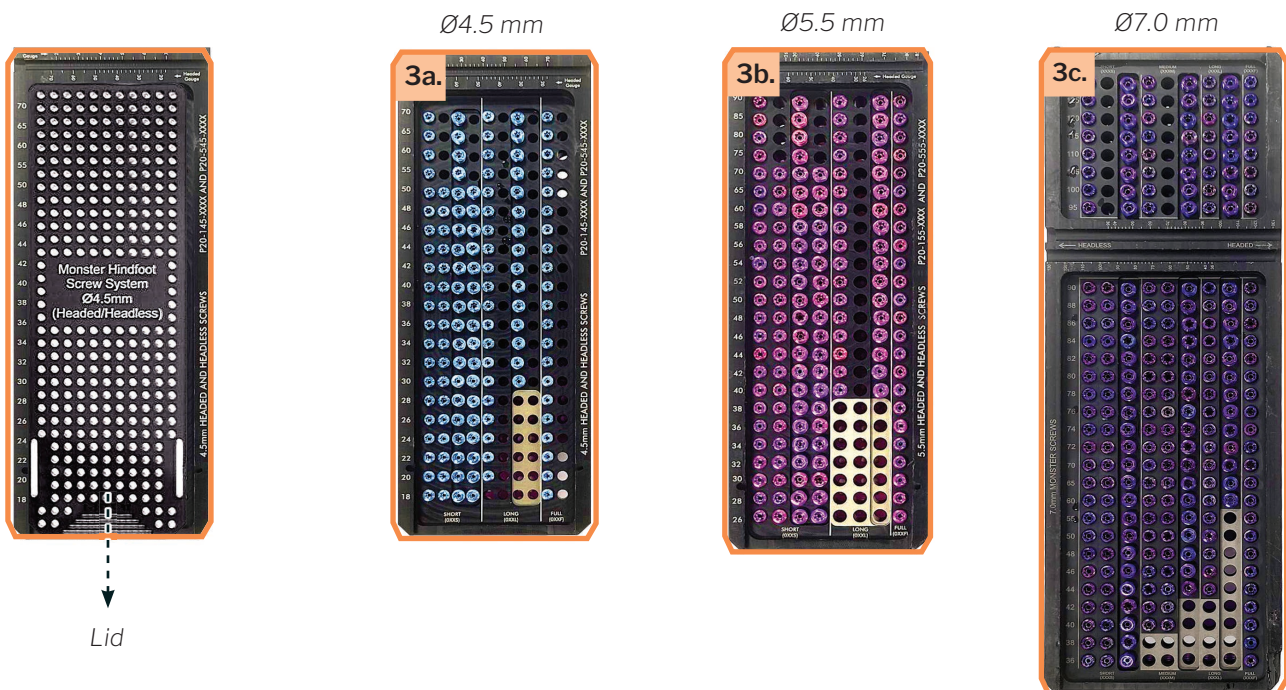

THE MINI-MONSTER® SCREW SYSTEM CADDY

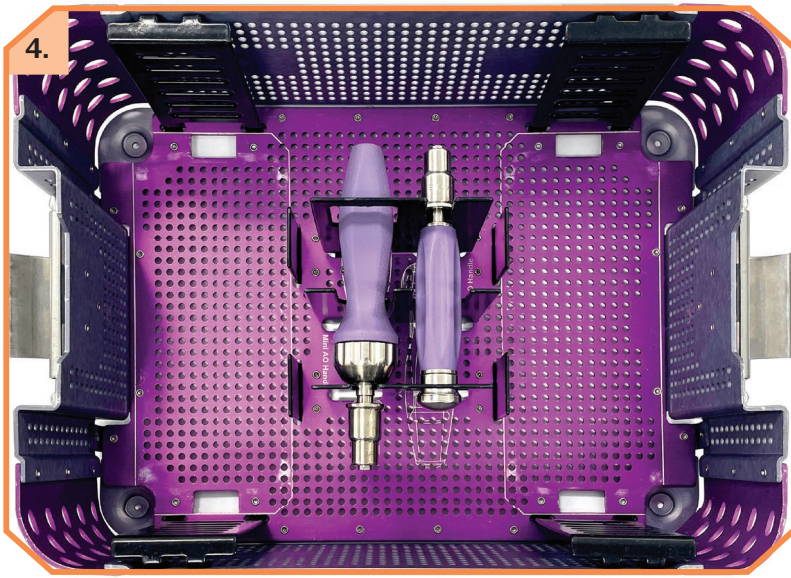

4. MINI-MONSTER® SCREW SYSTEM CASE

The Mini-Monster® Case contains both of the AO and Mini-AO Driver Handles and has available space for various configurations of desired screw caddy's. Configurations include 2-in-1 and 5-in-1.

MINI-MONSTER® SCREW SYSTEM CADDY

1a-1e. Each Mini-Monster® screw diameter contains an individual caddy for Headed Screws and Headless Screws. The tray beneath each Screw Caddy contains the instruments unique to the particular diameter screw chosen.

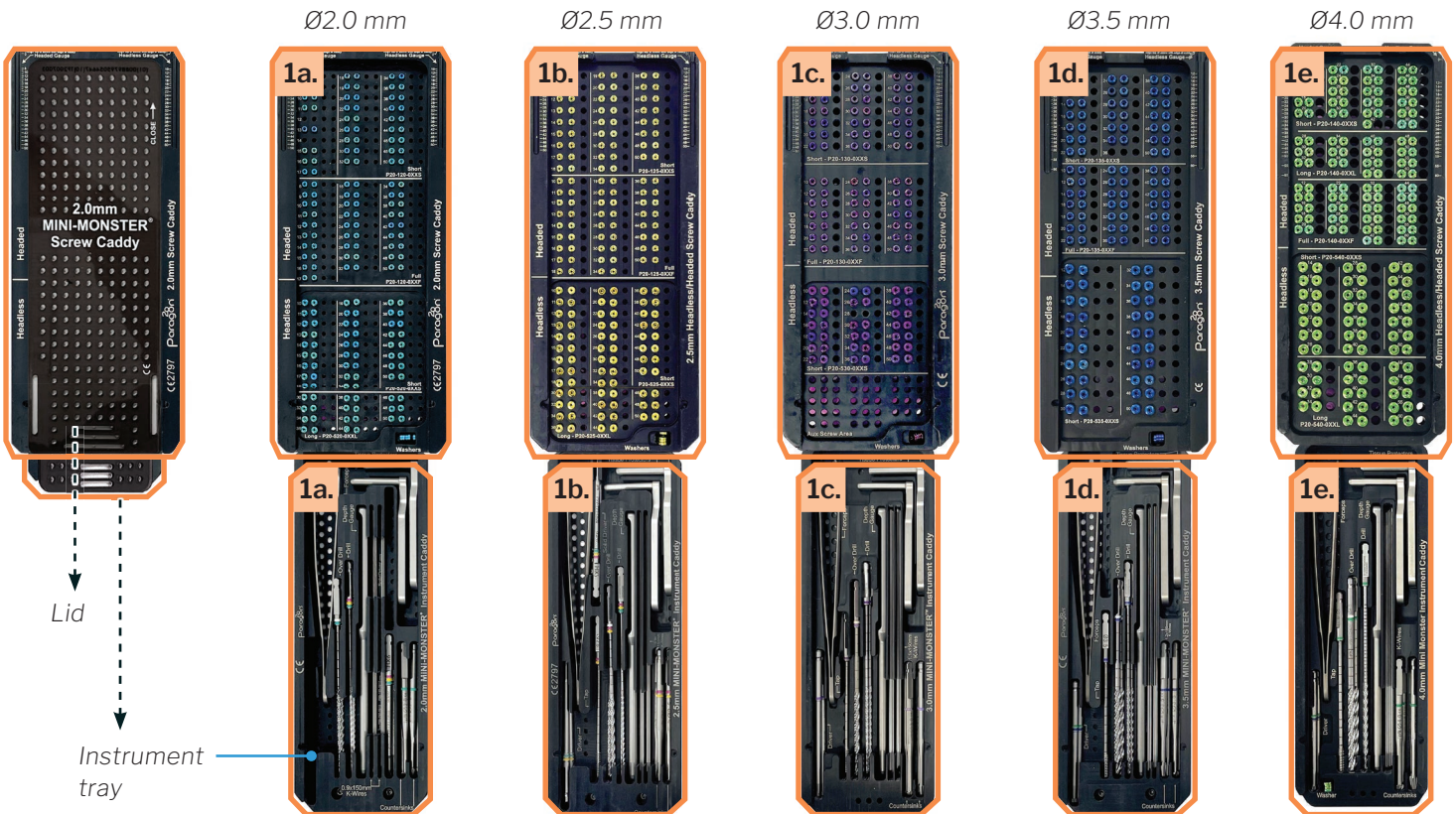

THE MONSTER[®] AND MINI-MONSTER[®] CASE OPTIONALITY

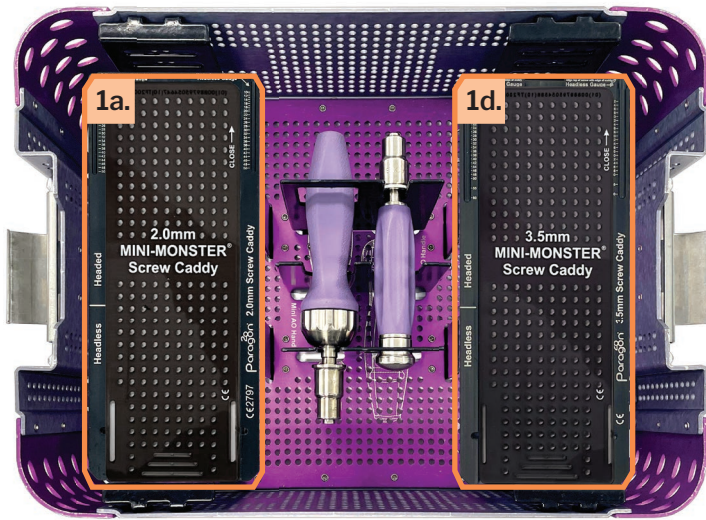

MINI-MONSTER[®] 2-IN-1 CASE OPTION:

The Mini-Monster[®] 2-in-1 option allows for two screw diameter caddies to be transported to a surgery.



MINI-MONSTER[®] 5-IN-1 CASE OPTION:

The Mini-Monster[®] 5-in-1 option allows for up to five screw diameter caddies to be transported to a surgery.

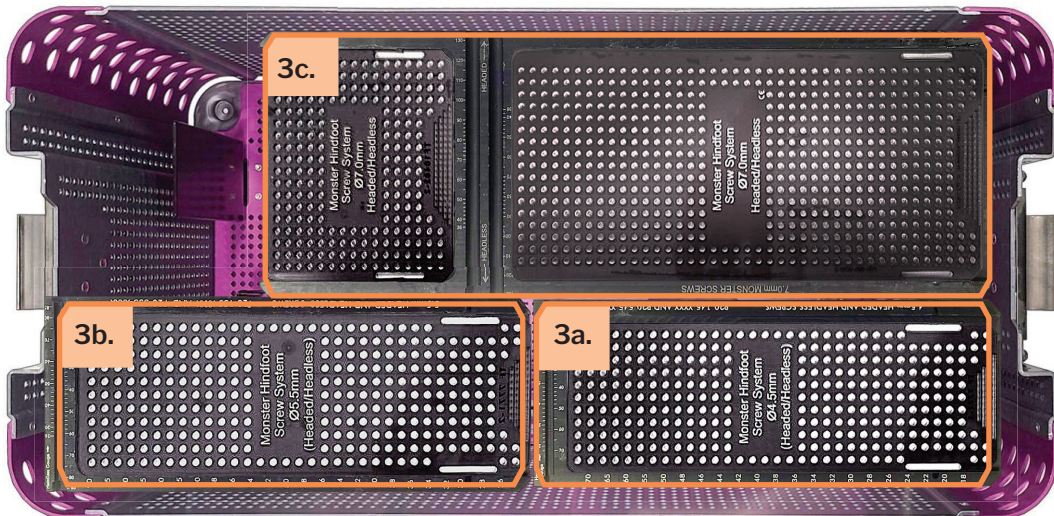

MONSTER[®] HINDFOOT CASE:

The Monster[®] Screw System Midfoot/ Hindfoot Set contains the screw caddy for Ø4.5 mm, Ø5.5 mm, Ø7.0 mm with both Headed and Headless variations.

Refer to www.paragon28.com/ifus for the complete and most current instructions for use document.

INDICATIONS FOR USE (MONSTER®)

The Monster® Screw System is indicated for use in bone reconstruction, osteotomy, arthrodesis, joint fusion, ligament fixation, fracture repair and fracture fixation, appropriate for the size of the device. Specific examples include:

Fractures and Osteotomies

- Fractures of the tarsals, metatarsals and other fractures of the foot (i.e. LisFranc)
- Avulsion fractures and fractures of the 5th metatarsal (i.e. Jones Fracture)
- Talar fractures
- Ankle fractures
- Navicular fractures
- Fractures of the fibula, malleolus, and calcaneus
- Metatarsal and phalangeal osteotomies
- Weil osteotomy
- Calcaneal osteotomy

Hallux Valgus Correction

- Fixation of osteotomies (i.e. Akin, Scarf, Chevron)
- Interphalangeal (IP) arthrodesis
- Proximal, midshaft, or distal osteotomy
- Lapidus arthrodesis

Arthrodesis/Deformity Correction

- 1st MTP arthrodesis
- Metatarsal deformity correction
- Tarsometatarsal joint arthrodesis
- Naviculocuneiform joint arthrodesis
- Talonavicular arthrodesis
- Subtalar joint arthrodesis
- Triple arthrodesis
- Medial column arthrodesis
- Subtalar joint distraction arthrodesis
- Ankle arthrodesis
- Lateralizing calcaneal osteotomy
- Lateral column lengthening
- Hammertoe

Fusion resulting from neuropathic osteoarthopathy (Charcot) such as:

- Medial and lateral column
- Subtalar, talonavicular, and calcaneocuboid

CONTRAINDICATIONS

Use of the Monster® Screw System is contraindicated in cases of inflammation, cases of active or suspected sepsis / infection and osteomyelitis; or in patients with certain metabolic diseases.

CONTRAINDICATIONS (CONTINUED)

All applications that are not defined by the indications are contraindicated. In addition, surgical success can be adversely affected by:

- Acute or chronic infections, local or systemic
- Vascular, muscular or neurological pathologies that compromise the concerned extremity
- All concomitant pathologies that could affect the function of the implant
- Osteopathies with reduced bone substance that could affect the function of the implant
- Any mental or neuromuscular disorder that could result in an unacceptable risk of failure at the time of fixation or complications in post-operative treatment
- Known or suspected sensitivity to metal
- Corpulence; an overweight or corpulent patient can strain the implant to such a degree that stabilization or implant failure can occur
- Whenever the use of the implant comes into conflict with the anatomical structures of physiological status

Other medical or surgical pre-conditions that could compromise the potentially beneficial procedure, such as:

- The presence of tumors
- Congenital abnormalities
- Immunosuppressive pathologies
- Increased sedimentation rates that cannot be explained by other pathologies
- Increased leukocyte (WBC) count
- Pronounced left shift in the differential leukocyte count

Refer to www.paragon28.com/ifus for the complete and most current instructions for use document.

POTENTIAL COMPLICATIONS AND ADVERSE REACTIONS

In any surgical procedure, the potential for complications and adverse reactions exist. The risks and complications with these implants include:

- Loosening, deformation or fracture of the implant
- Acute post-operative wound infections and late infections with possible sepsis
- Migration, subluxation of the implant with resulting reduction in range of movement
- Fractures resulting from unilateral joint loading
- Thrombosis and embolism
- Wound hematoma and delayed wound healing
- Temporary and protracted functional neurological perturbation
- Tissue reactions as the result of allergy or foreign body reaction to dislodged particles.
- Corrosion with localized tissue reaction and pain
- Pain, a feeling of malaise or abnormal sensations due to the implant used
- Bone loss due to stress shielding

All possible complications listed here are not typical of Paragon 28®, Inc. products but are in principle observed with any implant. Promptly inform Paragon 28® as soon as complications occur in connection with the implants or surgical instruments used. In the event of premature failure of an implant in which a causal relationship with its geometry, surface quality or mechanical stability is suspected, please provide Paragon 28® with the explant(s) in a cleaned, disinfected and sterile condition. Paragon 28® cannot accept any other returns of used implants. The surgeon is held liable for complications associated with inadequate asepsis, inadequate preparation of the osseous implant bed in the case of implants, incorrect indication or surgical technique or incorrect patient information and consequent incorrect patient behavior.

WARNINGS AND PRECAUTIONS

- Re-operation to remove or replace implants may be required at any time due to medical reasons or device failure. If corrective action is not taken, complications may occur.
- Use of an undersized screw in areas of high functional stresses may lead to implant fracture and failure.
- Plates and screws, wires, or other appliances of dissimilar metals should not be used together in or near the implant site.
- The implants and guide wires are intended for single use only. Re-use may cause product failure and could lead to disease transmission.
- Instruments, guide wires and screws are to be treated as sharps.
- Do not use other manufacturer's instruments or implants in conjunction with the Monster® Screw System.

MR SAFETY INFORMATION

The Monster® Screw System has not been evaluated for safety and compatibility in the MR environment. It has not been tested for heating, migration, or image artifact in the MR environment. The safety of the Monster® Screw System in the MR environment is unknown. Scanning a patient who has this device may result in patient injury.



PATENTED, DESIGNED & EXCLUSIVELY DISTRIBUTED BY



P20-STG-0001 RevK [2022-07-25]

™Trademarks and ®Registered Marks of Paragon 28®, Inc.

© Copyright 2022 Paragon 28®, Inc. All rights reserved.

Patents: www.paragon28.com/patents

Paragon 28, Inc. 
14445 Grasslands Dr.
Englewood, CO 80112 USA
(855) 786-2828

DISCLAIMER

The purpose of the Paragon 28® Monster®/Mini-Monster® Screw System Surgical Technique Guide is to demonstrate the optionality and functionality of the Paragon 28® Monster®/Mini-Monster® Screw System implants and instrumentation. Although variations in placement and use of the Paragon 28® Monster®/Mini-Monster® Screw System implants can be performed, the fixation options demonstrated in this technique were chosen to demonstrate the functionality of the system and for simplicity of explanation. Other uses for the Paragon 28® Monster®/Mini-Monster® Screw System can be employed, appropriate for the size of the device. CAUTION: Federal Law (USA) restricts this device to sale and use by, or on the order of, a physician.