

# **PHANTOM<sup>®</sup>**

**HINDFOOT TTC SYSTEM**

---

## **SURGICAL TECHNIQUE GUIDE**

Tibiotalocalcaneal Arthrodesis

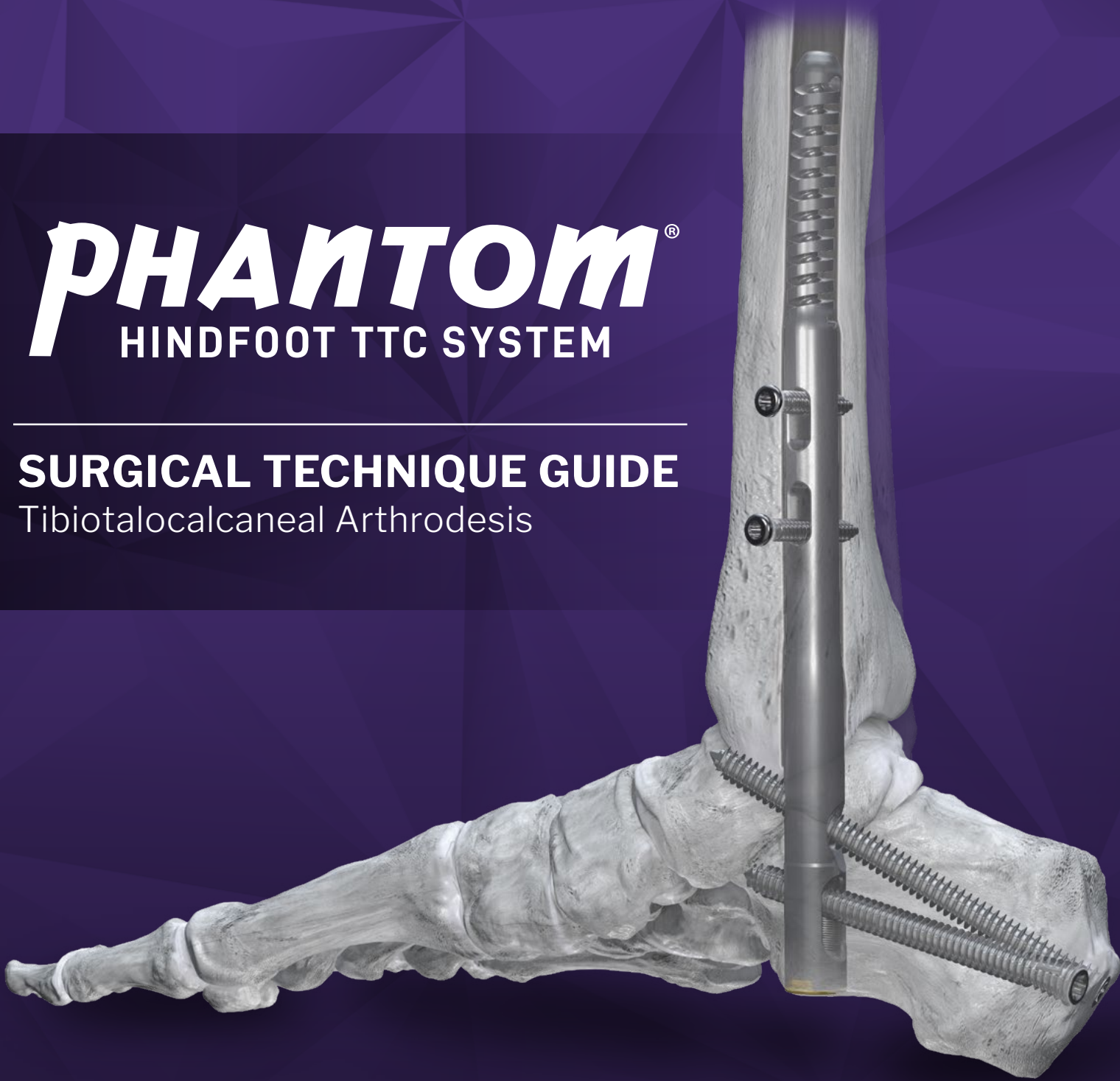

## CONTENTS

<b>SECTION 1</b>	<b>PHANTOM® HINDFOOT TTC/TC SYSTEM</b>
	PHANTOM SYSTEM ADVANTAGES..... 4
	PHANTOM TTC NAIL FEATURES ..... 5
	PRECISION® GUIDE FEATURES ..... 7
	GHOST™ OUTRIGGER FEATURES..... 8
	TIBIAL FIXATION OPTIONS..... 8
	PHANTOM TTC NAIL SYSTEM IMPLANTS ..... 9
	INTERNAL COMPRESSION SCREW ..... 9
	END CAP OPTIONS.....10
	COMPRESSION END CAP OVERVIEW .....10
	JOINT PREPARATION INSTRUMENTATION ..... 11
	INSTRUMENTATION ..... 12
<b>SECTION 2</b>	<b>TTC ARTHRODESIS USING THE PHANTOM TTC NAIL</b>
	PATIENT POSITIONING ..... 13
	INCISION/EXPOSURE - TIBIOTALAR AND SUBTALAR JOINTS ..... 13
	TIBIOTALAR AND SUBTALAR JOINT POSITIONING AND TEMPORARY FIXATION ..... 13
	IMPLANT SIZING..... 14
	ESTABLISH ENTRY POINT INCISION AND DRILL-PIN INSERTION ..... 15
	USE OF THE PRECISION GUIDE FOR DRILL-PIN PLACEMENT ..... 15
	ALTERNATIVE: FREEHAND DRILL-PIN INSERTION ..... 17
	OPTIONAL: USE OF THE PARALLEL OFFSET GUIDE..... 17

<b>SECTION 2 (CONTINUED)</b>	<b>TTC ARTHRODESIS USING THE PHANTOM® TTC NAIL</b>
	ENTRY DRILLING .....18
	STEPPED REAMING .....18
	FLEXIBLE REAMING .....19
	NAIL ASSEMBLY .....20
	ALIGNMENT CHECK ..... 21
	NAIL INSERTION .....23
	CALCANEAL THREADED PEG INSERTION .....25
	TIBIAL THREADED PEG INSERTION.....27
	INTERNAL COMPRESSION .....28
	SUBTALAR THREADED PEG INSERTION .....29
	OPTIONAL: SUBTALAR MONSTER® SCREW PLACEMENT OUTSIDE OF PHANTOM TTC NAIL..... 30-31
	OUTRIGGER REMOVAL ..... 31
	END CAP PLACEMENT..... 31
	CLOSURE..... 31
	IMPLANT REMOVAL .....32
	CASES.....33
<b>SECTION 3</b>	<b>INDICATIONS, CONTRAINDICATIONS, AND WARNINGS</b>
	PHANTOM HINDFOOT TTC/TC NAIL SYSTEM INDICATIONS, CONTRAINDICATIONS, AND WARNINGS.....34
	MONSTER INDICATIONS, CONTRAINDICATIONS, AND WARNINGS .....35

## PHANTOM® SYSTEM ADVANTAGES

- PRECISION® Guide Technology allows for precise and reproducible placement of the initial Drill-Pin to determine implant trajectory
- Internal Compression Screw allows for up to 8 mm of internal compression across the tibiotalar and subtalar joints
- Flex Coil Tip allows for stress-sharing within the tibia<sup>1</sup>
- Ø7.2 mm Headless, Threaded Pegs, in the calcaneus and across the subtalar joint for increased fixation
- Variable (0° - 18°) posterior-anterior Threaded Calcaneal Peg trajectory allows for precise placement and optimized purchase
- Distal end of Nail is Ø13.3 mm through the subtalar and tibiotalar joints
- Robust offering of joint preparation instrumentation for a tibiotalar and tibiotalocalcaneal arthrodesis

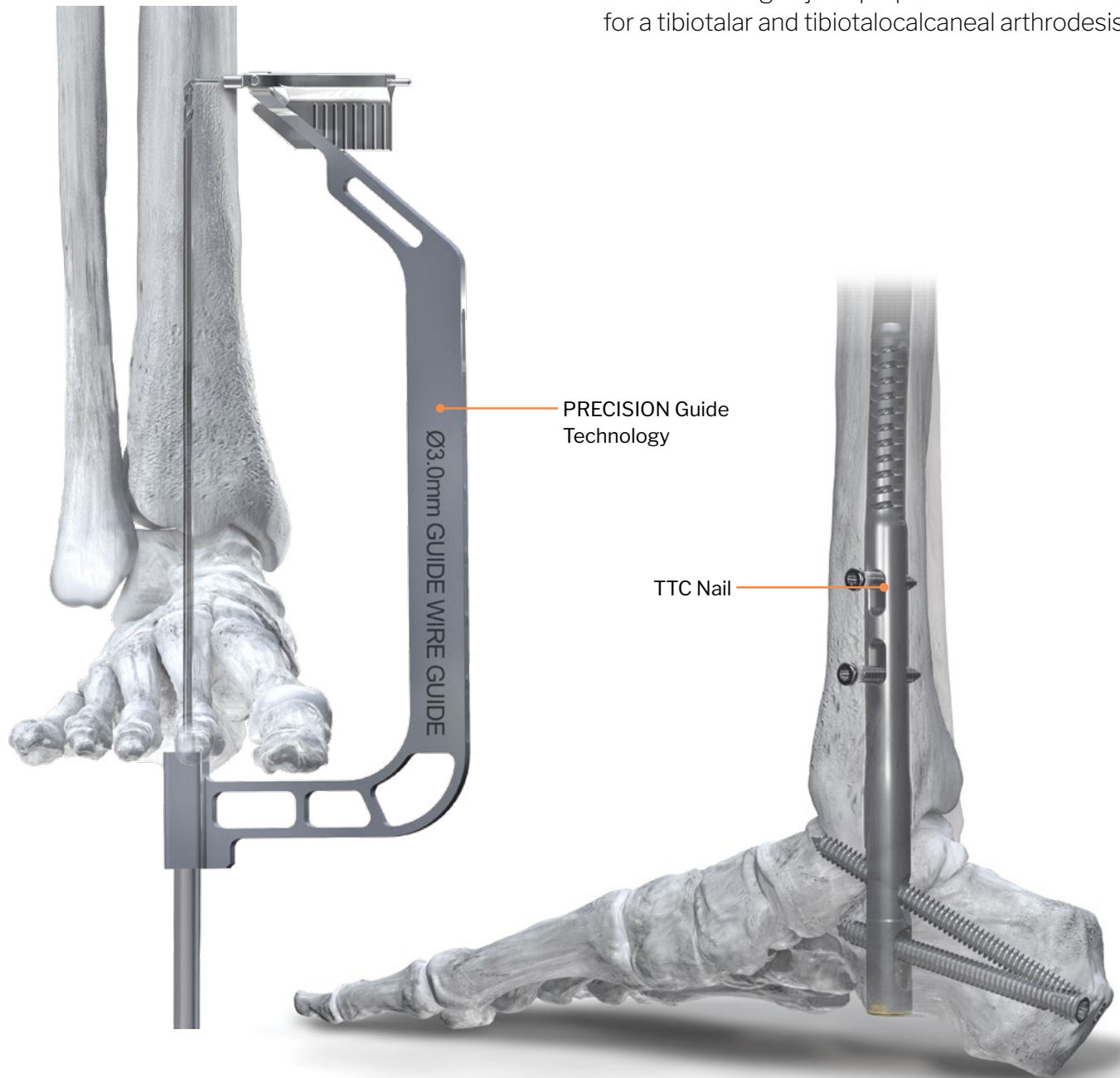

### ACKNOWLEDGMENT:

Paragon 28® would like to thank Michael Brage, MD for his contribution to the development of the surgical technique guide.

# PHANTOM® TTC NAIL FEATURES

- Constructed from type II anodized titanium alloy which has been shown to have increased fatigue strength<sup>2</sup>
- Available in right and left configurations to allow for optimal Threaded Peg positioning
- 250 mm and 300 mm length Nails feature a guided proximal Tibia Threaded Peg

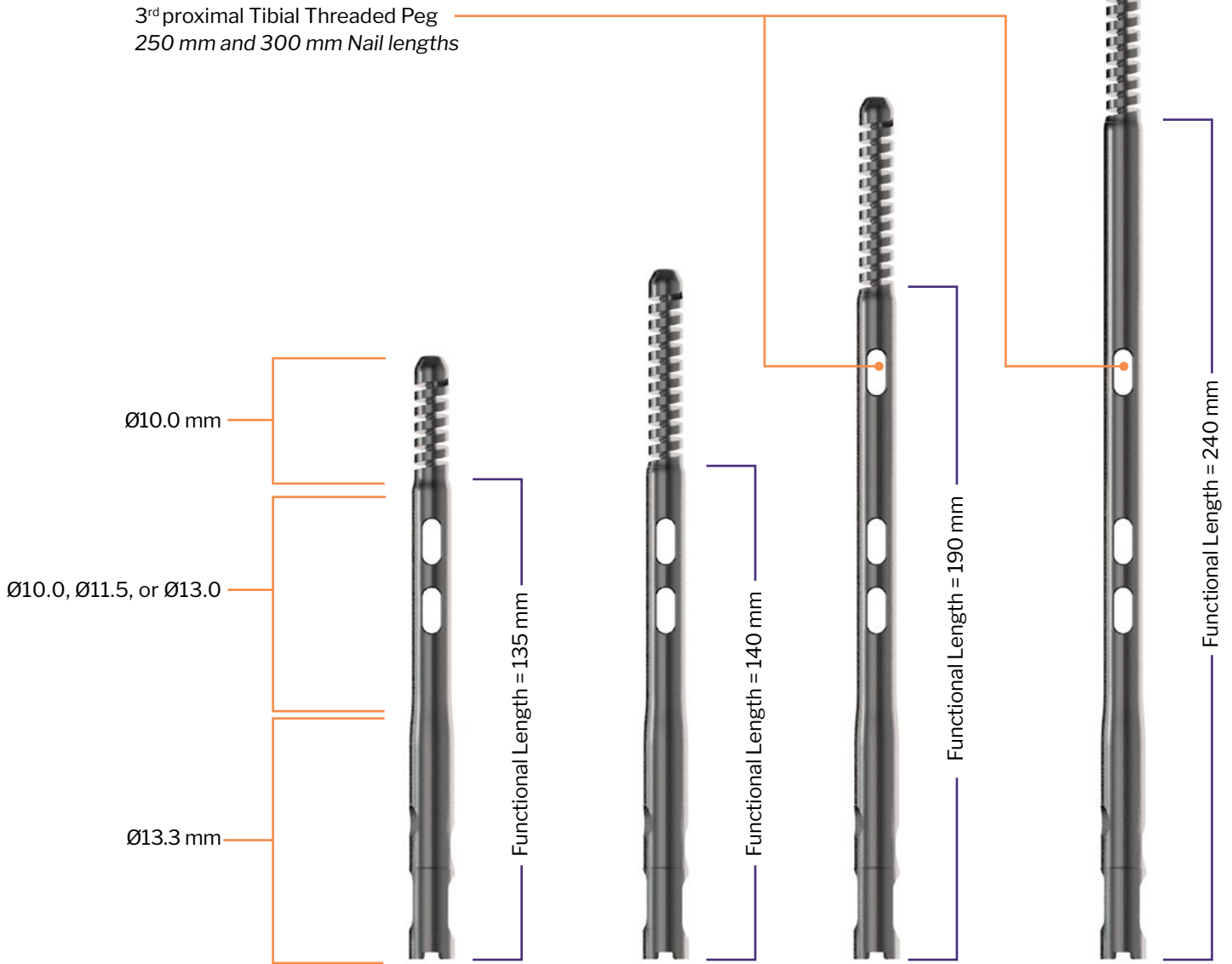

		LENGTH OPTIONS			
		175 mm	200 mm	250 mm	300 mm
FUNCTIONAL LENGTH		135 mm	140 mm	190 mm	240 mm
DIAMETER OPTIONS	Ø10.0 mm	●	●	●	●
	Ø11.5 mm	●	●	●	●
	Ø13.0 mm	●	●	●	

# PHANTOM<sup>®</sup> TTC NAIL FEATURES

POSTERIOR VIEW - RIGHT

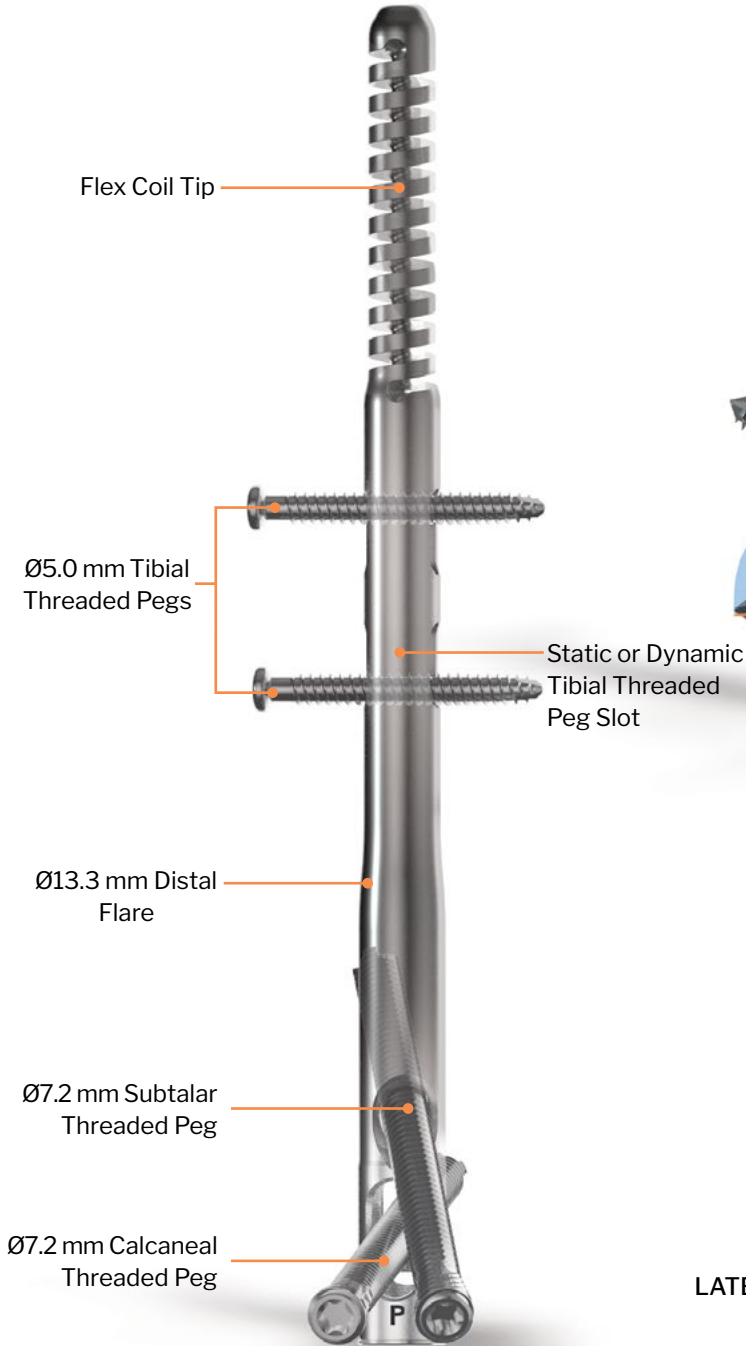

MEDIAL VIEW - RIGHT

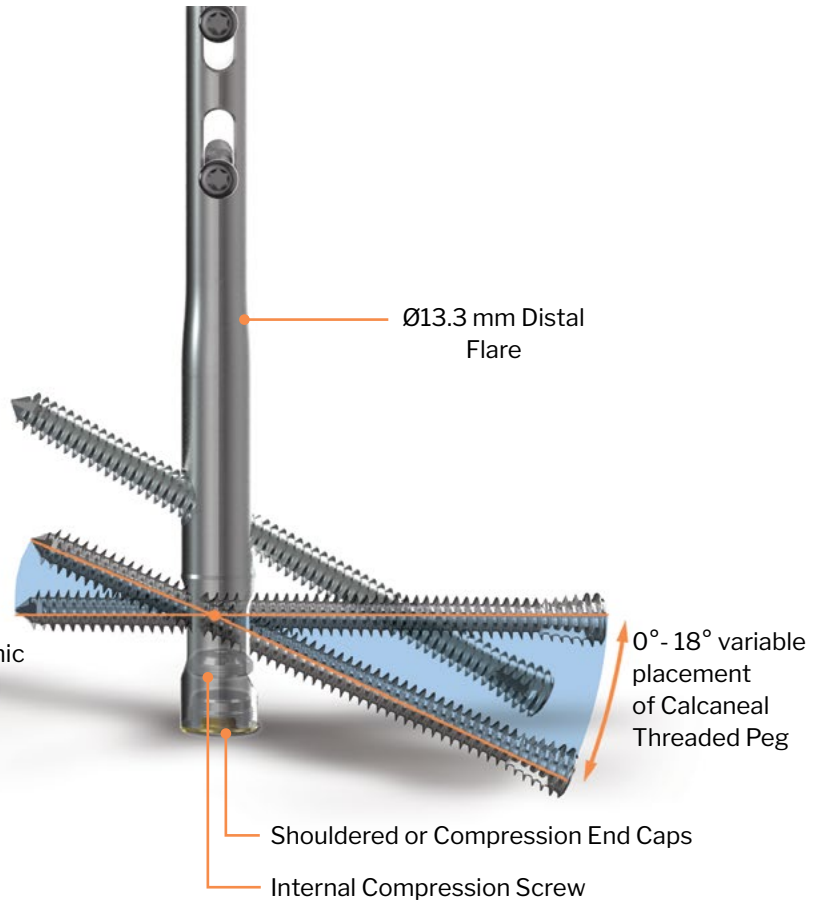

INFERIOR VIEW - RIGHT

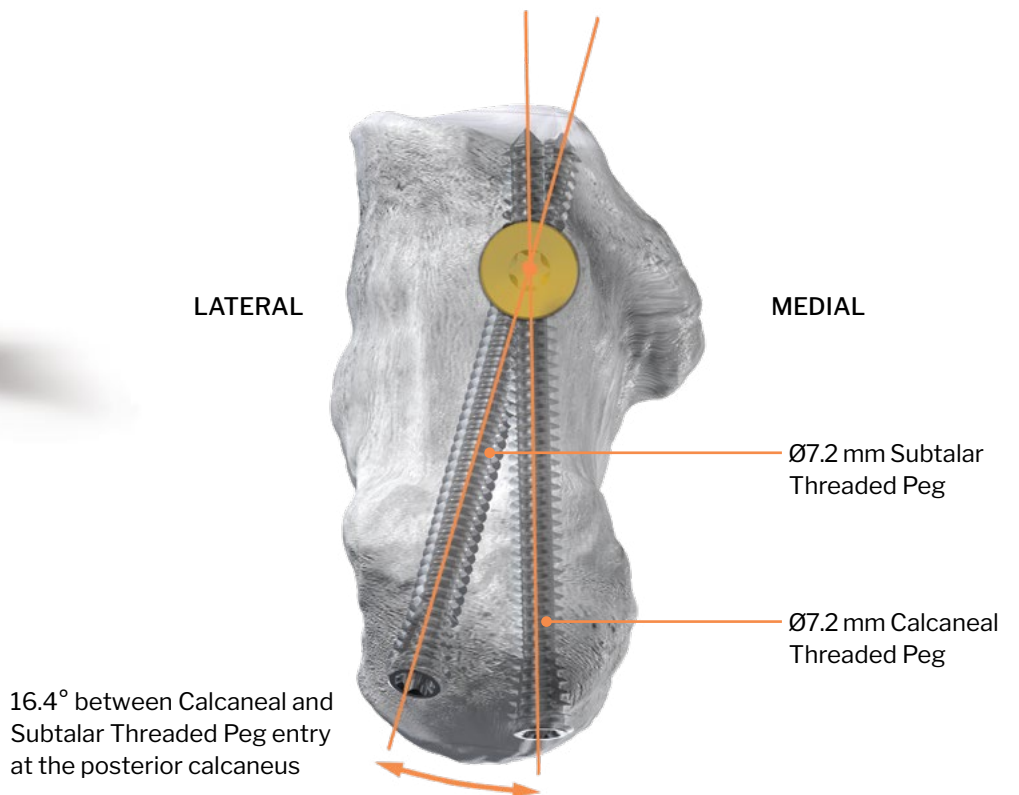

# PRECISION® GUIDE FEATURES

- PRECISION Guide Technology guides the initial placement of the Ø3.0 mm Drill-Pin in the distal to proximal direction
- Designed to reduce the number of Drill-Pin placement attempts to set Nail trajectory
- Termination point of the Sphere Wire is designed to be centered in the tibial canal to determine trajectory of the Drill-Pin
- Drill-Pin fluted tip design helps to prevent skiving

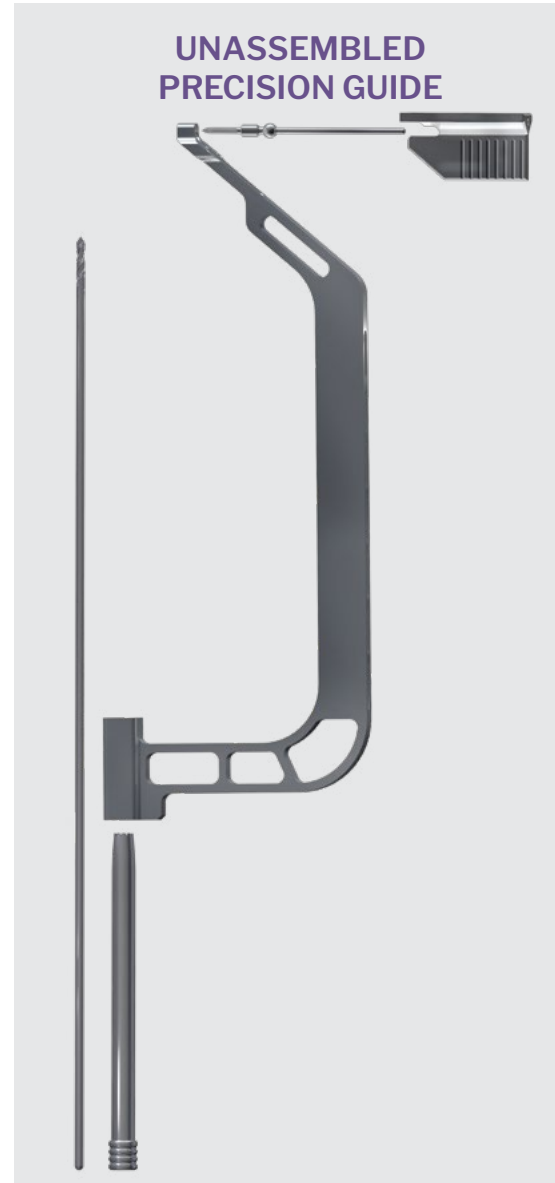
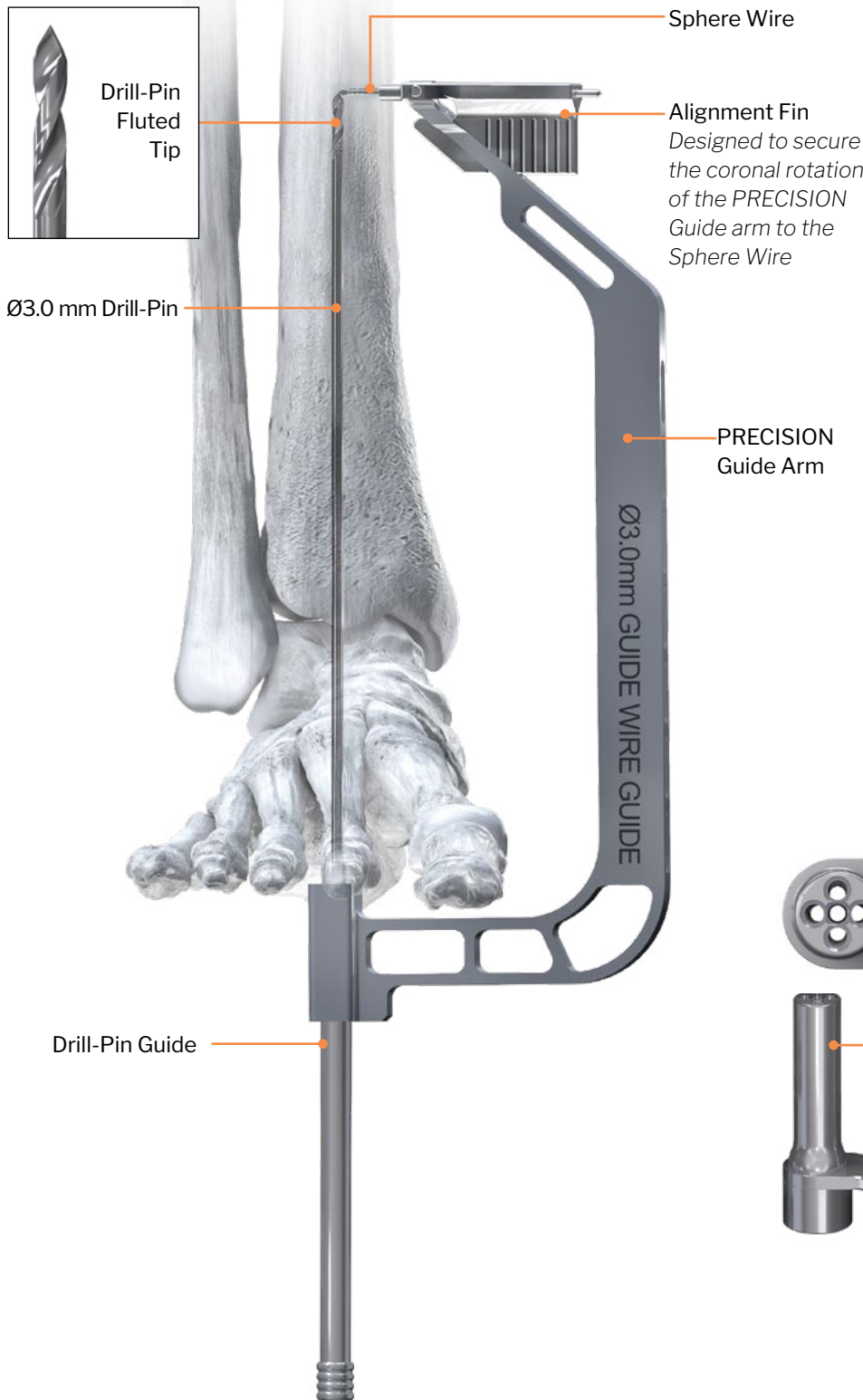

# GHOST™ OUTRIGGER FEATURES

## ANTERIOR VIEW (RIGHT CONFIGURATION)

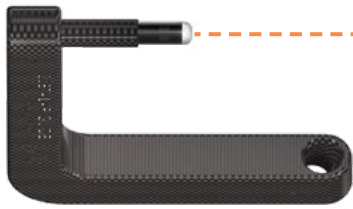

Subtalar Guide Arm

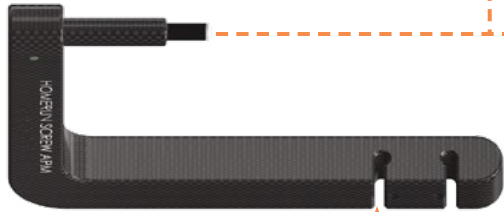

Home Run Screw Arm



Monster® Screw K-wire Guides

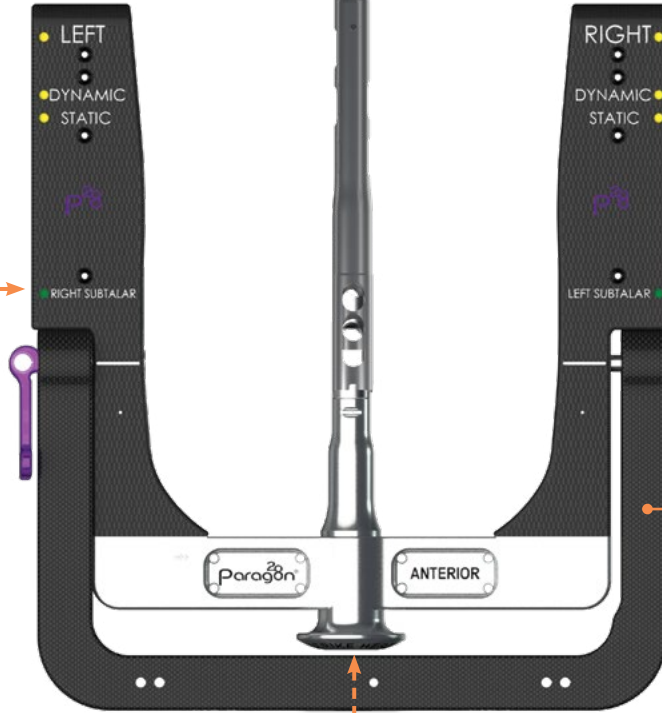

Proximal Guide Arm  
250 mm and 300 mm  
Nail lengths

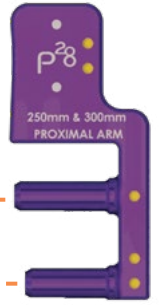

Calcaneal Guide Arm

Mounting Bolt

Mounting Driver

## TIBIAL FIXATION OPTIONS



### STATIC:

- Constructs a static Nail within that Tibia, allowing for future weight-bearing compression with removal of distal Tibia Threaded Peg

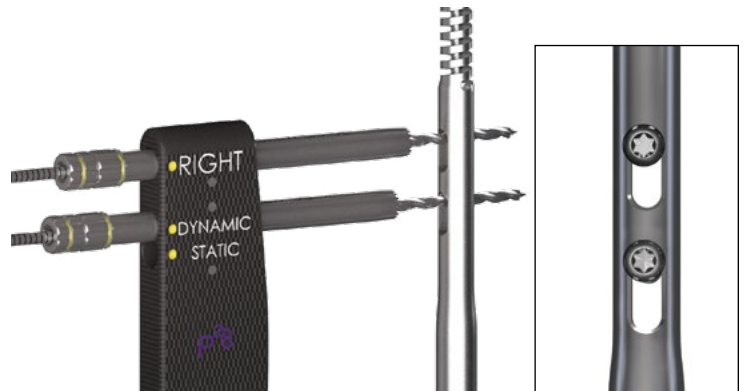



















### DYNAMIC:

- Constructs a weight-bearing compression Nail within the tibia



# PHANTOM® TTC NAIL SYSTEM IMPLANTS

## THREADED PEG OFFERING:

	TIBIA THREADED PEG	CALCANEAL THREADED PEG	SUBTALAR THREADED PEG
			
<b>DIAMETER:</b>	Ø5.0 mm	Ø7.2 mm	
<b>LENGTH:</b>	20 mm - 70 mm in 2 mm increments	45 mm - 120 mm in 5 mm increments	
<b>COLOR INSTRUMENTS:</b>			
<b>DRIVER:</b>	TX-20 - Long 	TX-30 - Long 	
<b>DRILL:</b>	Ø3.8 mm x 250 mm 	Ø4.6 mm x 300 mm - Solid 	Ø4.6 mm x 300 mm - Cannulated 
<b>DRILL GUIDE:</b>	Tibial Drill Guide 	Calcaneal Drill Guide 	Subtalar Drill Guide 
<b>PEG GUIDE:</b>	Tibial Peg Guide 	Calcaneal Peg Guide 	Subtalar Peg Guide 
<b>K-WIRE:</b>	-	Ø2.3 mm 	
<b>K-WIRE GUIDE:</b>	-	Ø2.3 mm 	

## INTERNAL COMPRESSION SCREW



- Placed in Nail prior to attaching to Outrigger
- Pushes against Calcaneal Threaded Peg to compress both the tibiotalar and subtalar joints
- Provides up to 8 mm of internal compression

# END CAP OPTIONS

- Placed in Nail after Threaded Peg placement and Outrigger removal
- Fills the Countersink void and helps to prevent bone ingrowth at the distal end of the Nail

## SHOULDERED END CAP



- Can be used in combination with the Internal Compression Screw



- Longer shoulder (bottom image) fills larger Countersink void

## COMPRESSION END CAP



- Used without the Internal Compression Screw



- Pushes against the Calcaneal Threaded Peg to provide up to 8 mm of compression across the tibiotalar joint

# COMPRESSION END CAP OVERVIEW

## SHORT COMPRESSION END CAP

0 mm of compression



3 mm proud

2 mm of compression



1 mm proud

8 mm of compression



5 mm countersunk

## LONG COMPRESSION END CAP

0 mm of compression



7 mm proud

2 mm of compression



5 mm proud

8 mm of compression



1 mm countersunk

# JOINT PREPARATION INSTRUMENTATION

Bone Fenestration Perforator



Curved Bone Fenestration Chisel



Honeybadger



Straight Ring Curette



Angled Ring Curette



Straight 3 mm Osteotome



Straight 6 mm Osteotome



Straight 12 mm Osteotome



Oval Burr



Barrel Burr



Straight Bone Fenestration Chisel



Straight Curette



Angled Curette



Curved 3 mm Osteotome



Curved 6 mm Osteotome



Curved 12 mm Osteotome



Hindfoot Distractor

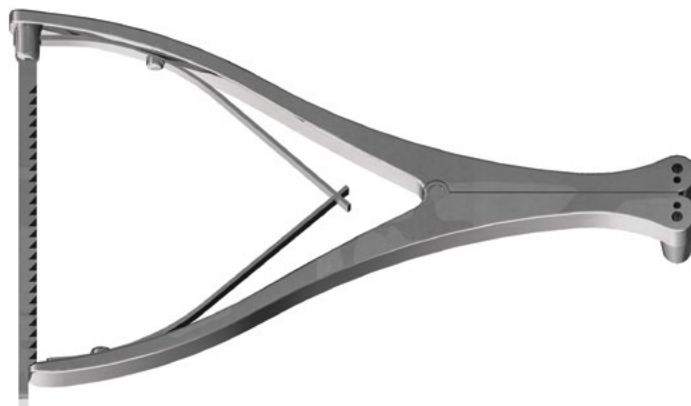

Ø2.0 mm K-wire



Ø2.3 mm K-wire



# INSTRUMENTATION

Ø3.0 mm Drill-Pin



Ø7.0 mm Entry Drill



Ø13.5 mm Stepped Reamer



Ball-Tipped Guide Rod

(Available in Ø3.0 mm x 550 mm and Ø3.0 mm x 800 mm)

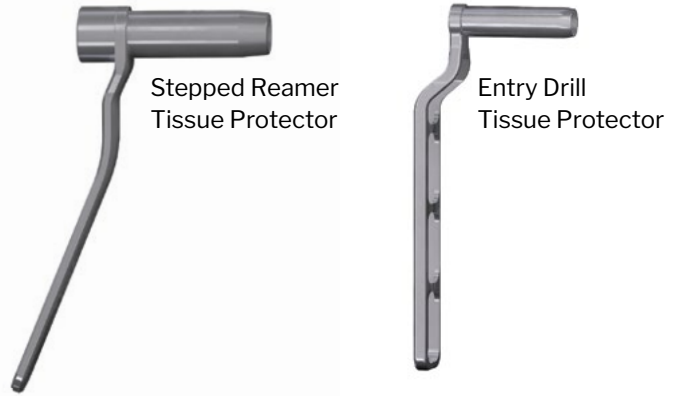

345 mm Flexible Reamer Shaft

(For all Nails up to 250 mm length)

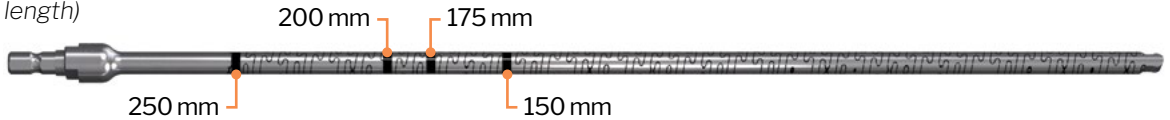

417 mm Flexible Reamer Shaft

(For all Nail lengths)

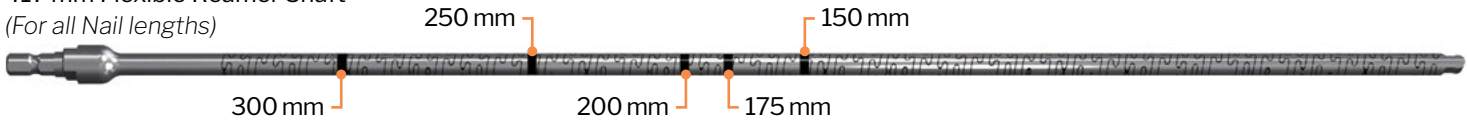

## REAMER HEADS



Thor Hammer



Handle



T-Handle

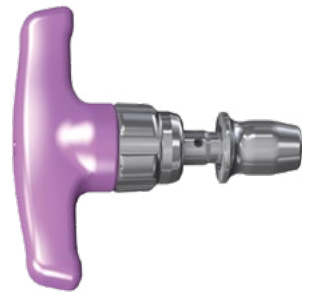

Slap Hammer



Jacobs Adapter



Cannulated Depth Gauge



Solid Depth Gauge



TX-20 Driver

(Available in short and long)



TX-30 Driver

(Available in short and long)



## PATIENT POSITIONING

Patient positioning is per surgeon preference, and may depend on the pathology and/or previous surgical approaches for a particular patient. Patient positioning options include supine with an ipsilateral bump, lateral decubitus, or prone.

A radiolucent table is recommended for this procedure. Prepare the entire foot and lower limb such that the patient is draped above the knee and visualization of the knee and lower limb is present to allow for assessment of lower limb alignment. The distal limbs should extend just over the operating room table. A large C-arm should be available for entry over the operative site from the contralateral side.

## INCISION/EXPOSURE – TIBIOTALAR AND SUBTALAR JOINTS

Pre-existing deformities can be addressed and corrected at this time. Anatomical considerations may determine the surgeon's preferred approach to access the tibiotalar and subtalar joints for cartilage removal and alignment. A pin distractor is provided to allow for space and visualization during joint preparation, if needed, and is to be used with provided  $\varnothing 2.0$  mm or  $\varnothing 2.3$  mm K-wires.

Prepare the tibiotalar joint and the anterior, middle, and posterior facets of the subtalar joint for arthrodesis according to surgeon's preferred technique and approach using the provided joint preparation instrumentation. Following cartilage removal, it is advised to fenestrate the subchondral plate with the subchondral drill, burrs, and/or bone fenestration chisels to promote healing.

## TIBIOTALAR AND SUBTALAR JOINT POSITIONING AND TEMPORARY FIXATION

Align the tibiotalar and subtalar joint. The tibiotalar joint should be positioned neutral with respect to dorsiflexion and plantarflexion. The foot should be in  $5^\circ$  of hindfoot valgus and  $0^\circ$  -  $5^\circ$  of calcaneal external rotation equal to the contralateral side<sup>3</sup>. Medialization of the calcaneus or talus may be necessary to allow for better positioning of the calcaneus and talus inferior relative to the tibia.

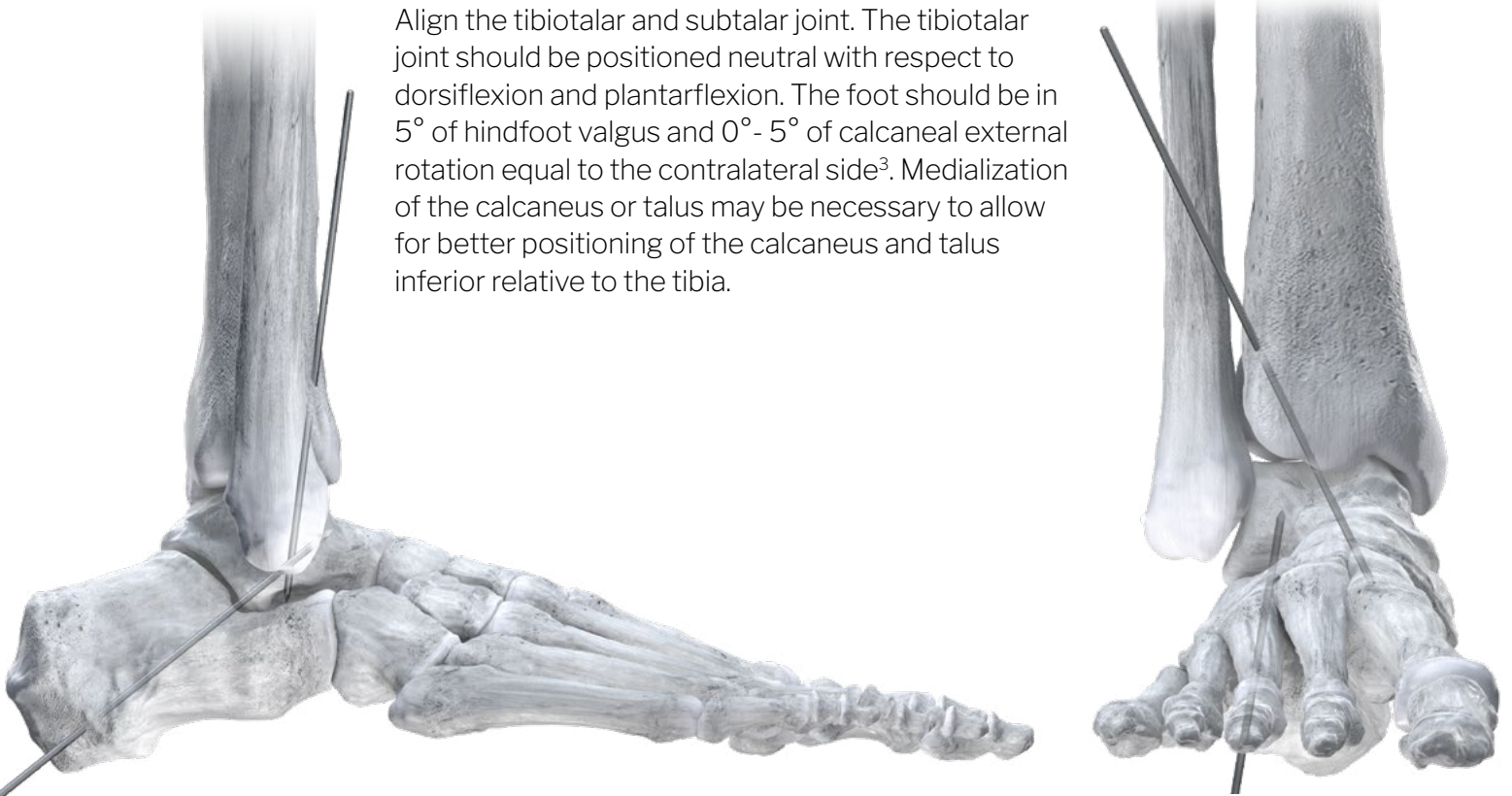

With the subtalar joint and tibiotalar joint held in this alignment, use the provided  $\varnothing 2.0$  mm K-wires to temporarily fix the tibiotalar joint and the subtalar joint in the preferred alignment. The wire across the tibiotalar joint should pass from the anterolateral tibia to the anteromedial talus, avoiding the anticipated path of the Nail. The wire across the subtalar joint should be placed laterally.

# IMPLANT SIZING

## IMPLANT SIZER

Place the Implant Sizer over the medial or lateral side of the leg. Ensure a proper lateral view of the leg is seen under fluoroscopy using the Fluoro Alignment Hole. The Fluoro Alignment Hole should be fully in view to confirm the proper rotation of the Implant Sizer.

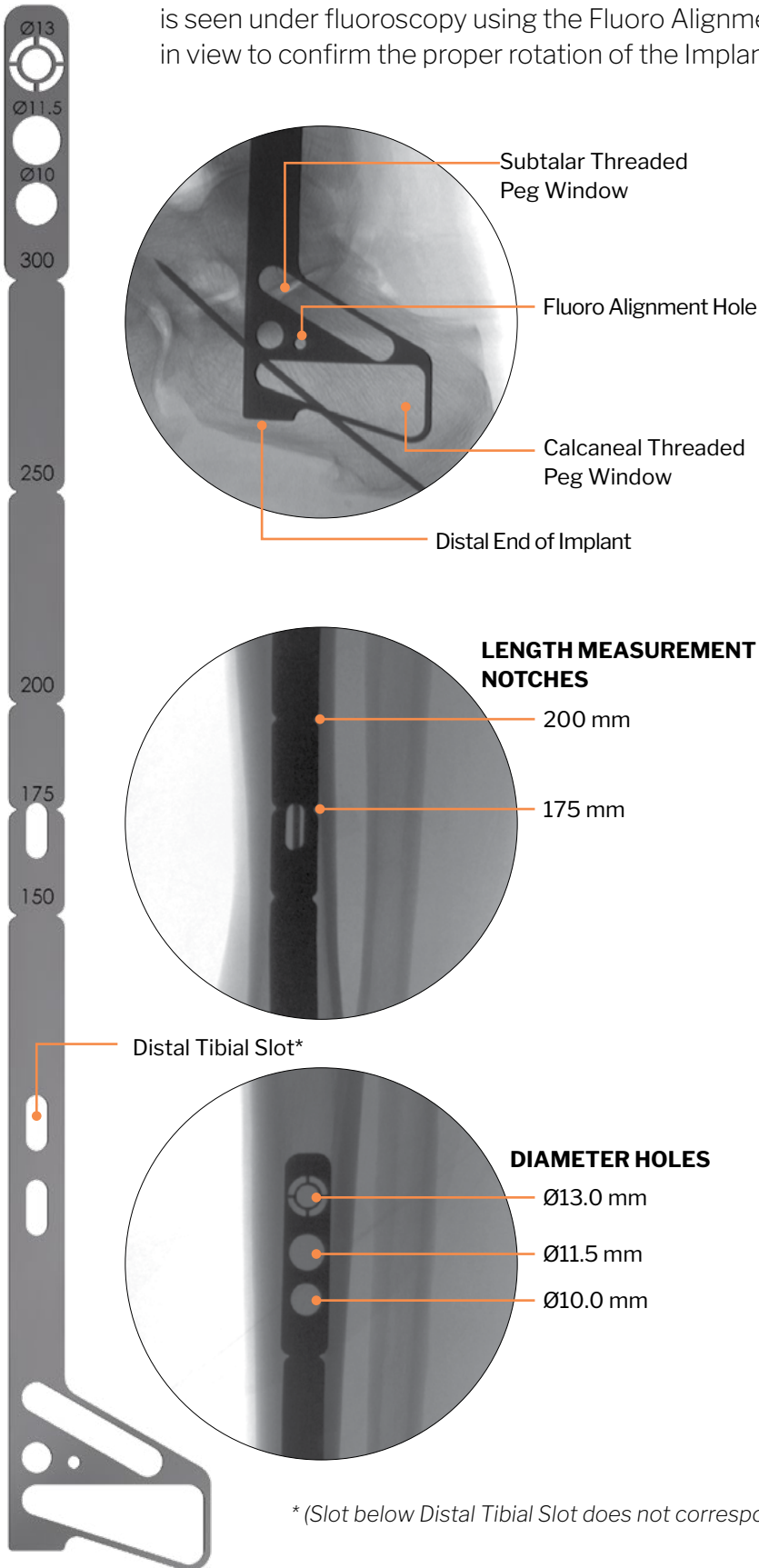

### Perform the following checks to anticipate position of the Nail:

- Ensure Subtalar Threaded Peg Window is within the calcaneus with an appropriate start point.
- Ensure the Tibial Slots are in proper positioning and above the tibiotalar joint.
- Ensure the Calcaneal Threaded Peg Window is within the calcaneus with an appropriate start point.
- Ensure the distal end of the Implant Sizer is 5 mm countersunk in preparation for internal compression.

### The appropriate Nail length can be determined within the tibia utilizing the Length Measurement Notches.

- Nail length offerings include: 175 mm, 200 mm (shown), and 250 mm, 300 mm (not shown).

### Slide the Implant Sizer distally such that the Diameter Holes are over the projected proximal termination point of the Nail.

- Determine approximate Nail diameter by selecting which Diameter Hole best fills the tibia canal without violating the cortex.

\* (Slot below Distal Tibial Slot does not correspond to a tibial peg location)

# ESTABLISH ENTRY POINT INCISION AND DRILL-PIN INSERTION

A PRECISION® Guide is available for Drill-Pin placement, with instructions below for setup and use. If the PRECISION Guide is not used, proceed to page 17 for freehand Drill-Pin insertion instructions.

## USE OF THE PRECISION GUIDE FOR DRILL-PIN PLACEMENT

Position the distal end of the PRECISION Guide approximately one fingerbreadth plantar to the fat pad of the heel, with the proximal aspect of the PRECISION Guide Arm positioned along the anterior medial face of the tibia. Mark the entry point for the Sphere Wire and make a small stab incision at the area of intended Sphere Wire placement centrally over the anterior medial face of the tibia. Position the Sphere Wire perpendicular to the anterior medial face of the tibia and parallel to the neutral foot.

Drive the Sphere Wire until the “can” portion contacts bone.

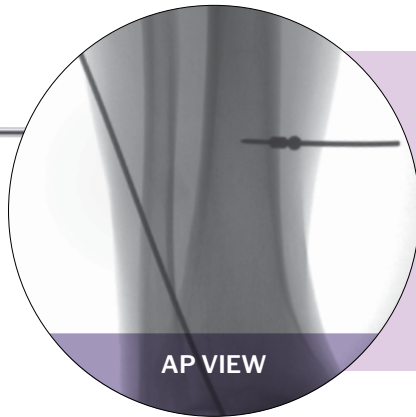

Confirm placement using an AP view on fluoroscopy to ensure that the tip of the Sphere Wire is centered in the medullary canal.

The Drill-Pin's trajectory will terminate at the tip of the Sphere Wire, thus the Sphere Wire insertion depth may need to be adjusted according to patient anatomy.

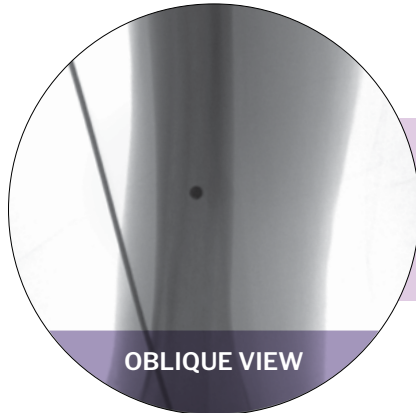

Take an oblique fluoroscopic view down the center of the wire to ensure that the Sphere Wire is centered in the anterior medial face of the tibia.

## USE OF THE PRECISION<sup>®</sup> GUIDE FOR DRILL-PIN PLACEMENT



Attach the PRECISION Guide Arm to the Sphere Wire proximally.



Insert the PRECISION Guide Alignment Fin such that the hole in the Alignment Fin receives the Sphere Wire. The fin portion is inserted into the oblong recess of the PRECISION Guide Arm to allow the two prongs of the fin to grasp the sphere.



Position the Drill-Pin Guide through the distal aspect of the PRECISION Guide. Place a Ø3.0 mm Drill-Pin into the Drill-Pin Guide.

A plantar incision is made just distal to the plantar fat pad, slightly lateral to midline. Blunt dissection is carried down to the plantar calcaneus to avoid disruption of nearby neurovascular bundles. The tip of the Ø3.0 mm Drill-Pin is placed against the plantar aspect of the calcaneus. A lateral fluoroscopic image is taken to ensure correct distal to proximal trajectory of the Drill-Pin.

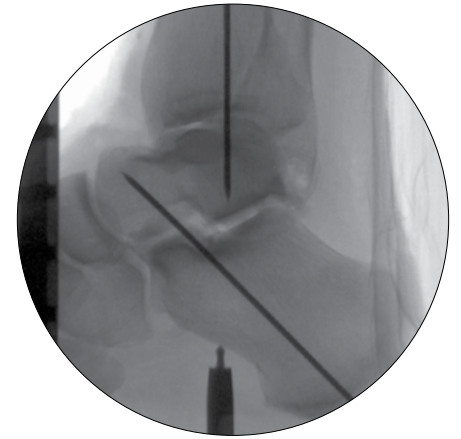

Confirm intended Drill-Pin start point via lateral fluoroscopy.

Upon establishing the correct start point on lateral fluoroscopy, drive the Ø3.0 mm Drill-Pin into the calcaneus, talus, and tibia using AP, lateral, and calcaneal axial fluoroscopic views during and after the process. Ensure that the Drill-Pin is centered in the calcaneus, talus, and tibia to terminate in the medullary canal of the tibia, just proximal to the metaphyseal flair.

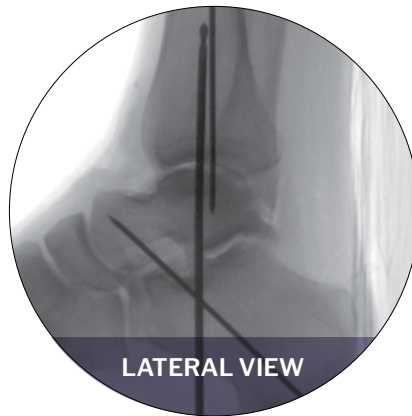
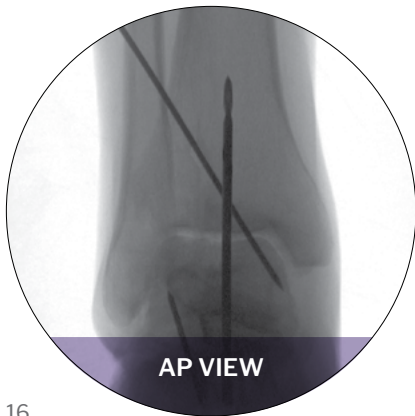



## USE OF THE PRECISION® GUIDE FOR DRILL-PIN PLACEMENT



Remove the Alignment Fin from the Sphere Wire and remove the Drill-Pin Guide from the PRECISION Guide Arm. Detach the PRECISION Guide Arm from the Sphere Wire and slide over the Drill-Pin.

Remove the Sphere Wire from the tibia.

## ALTERNATIVE: FREEHAND DRILL-PIN INSERTION

A plantar incision is made just distal to the plantar fat pad, slightly lateral to midline. Blunt dissection is carried down to the plantar calcaneus to avoid disruption of nearby neurovascular bundles. The tip of the Ø3.0 mm Drill-Pin is placed against the plantar aspect of the calcaneus. A lateral fluoroscopic image is taken to ensure correct distal to proximal trajectory of the Drill-Pin.

Upon establishing the correct start point, drive the Ø3.0 mm Drill-Pin into the calcaneus, talus and tibia using AP, lateral and calcaneal axial fluoroscopic views during and after the process to ensure that the Drill-Pin is centered in the calcaneus, talus, and tibia to terminate in the medullary canal of the tibia, just proximal to the metaphyseal flare as shown on page 16.



## OPTIONAL: USE OF THE PARALLEL OFFSET GUIDE

If angulation of the Drill-Pin is suitable, but the Drill-Pin position is too anterior, posterior, medial or lateral, the Parallel Offset Guide can be used. Slide the Parallel Offset Guide central hole over the initial Drill-Pin. Place a second wire in any of the adjacent holes to allow for this second Drill-Pin to be placed parallel to the first, offset 4 mm center-to-center in any direction. Remove the initial Drill-Pin and the Parallel Offset Guide.

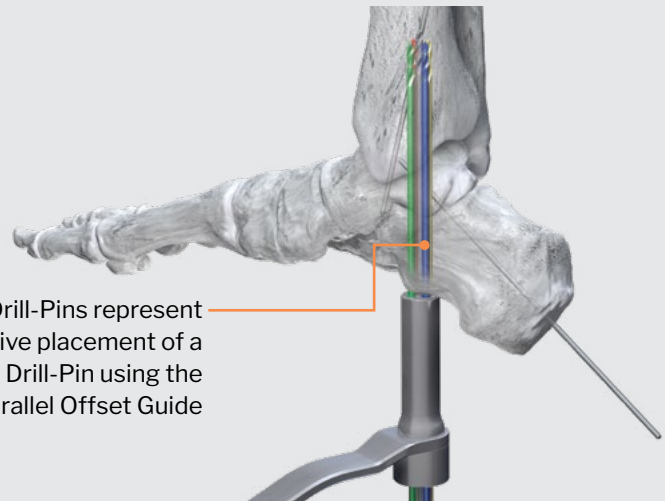

Colored Drill-Pins represent alternative placement of a second Drill-Pin using the Parallel Offset Guide

## ENTRY DRILLING



An extension of the plantar incision is made, if necessary, such that the plantar incision measures 3-4 cm. Perform blunt dissection to the plantar surface of the calcaneus as needed. Place the Entry Drill Tissue Protector over the Drill-Pin and position within the incision and against the calcaneal cortex.



Insert the Entry Drill Tissue Protector and the Ø7.0 mm Entry Drill over the Drill-Pin, and advance the drill proximally, confirming the drill path trajectory under fluoroscopy at each joint. Drill past the metaphyseal flare in the tibia. Remove the Ø7.0 mm Entry Drill and Entry Drill Tissue Protector while maintaining the position of the Drill-Pin.

## STEPPED REAMING

Insert the Stepped Reamer Tissue Protector and Stepped Reamer over the Drill-Pin. Ream proximally until the laser mark on the Stepped Reamer reaches the Tissue Protector.



### TIP:

Insert the Stepped Reamer Tissue Protector and Stepped Reamer over the Drill-Pin. Ream proximally until the laser mark on the stepped drill reaches the Tissue Protector.

*It is recommended to check lateral fluoroscopy to ensure that the larger Ø13.5 mm diameter contacts the metaphyseal bone of the tibia and that the proximal portion of the drill matches the intended Countersink of the Nail.*

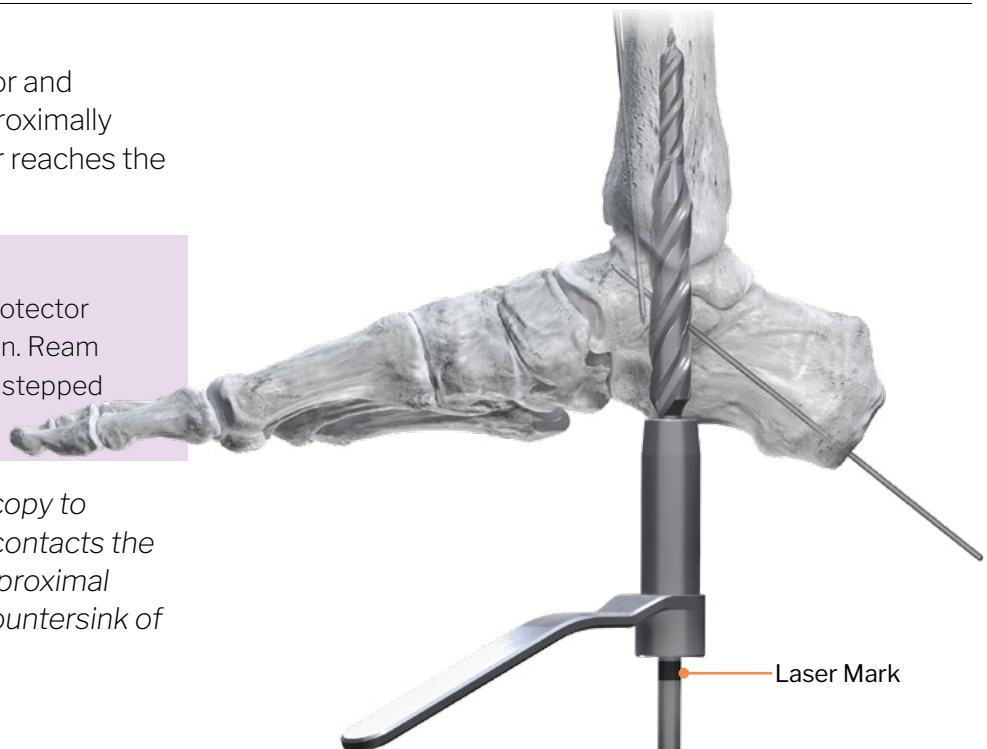

# FLEXIBLE REAMING

Following stepped reaming, remove the Drill-Pin, and place the Ball-Tipped Guide Rod from the plantar aspect of the calcaneus into the distal tibia. Temporary fixation can be removed at this time or after placement of the Nail, per surgeon preference. The Thor Hammer may be used to fully seat the Ball-Tipped Guide Rod within the canal. Confirm position and length of the Ball-Tipped Guide Rod using fluoroscopy.



Attach the desired Reamer Head to the Reamer Shaft. It is recommended to begin with the smallest diameter Reamer Head (Ø8.0 mm), thus creating a Reamer Construct.

Insert the Stepped Reamer Tissue Protector over the Ball Tipped Guide Rod into the incision. Using the Reamer Construct, ream over the Ball-Tipped Guide Rod until the laser marking on the Reamer Shaft meets the Tissue Protector. Ream incrementally in Ø0.5 mm increments, increasing in size until desired resistance is reached while confirming under fluoroscopy. It is recommended to undersize the Nail diameter by Ø1.0 - Ø1.5 mm from the largest reamed diameter. Remove the Ball-Tipped Guide Rod from the tibial canal once reaming is complete.



**TIP:**

While under power, the reverse function can help to alleviate resistance during Reamer Construct withdrawal from the tibial canal.

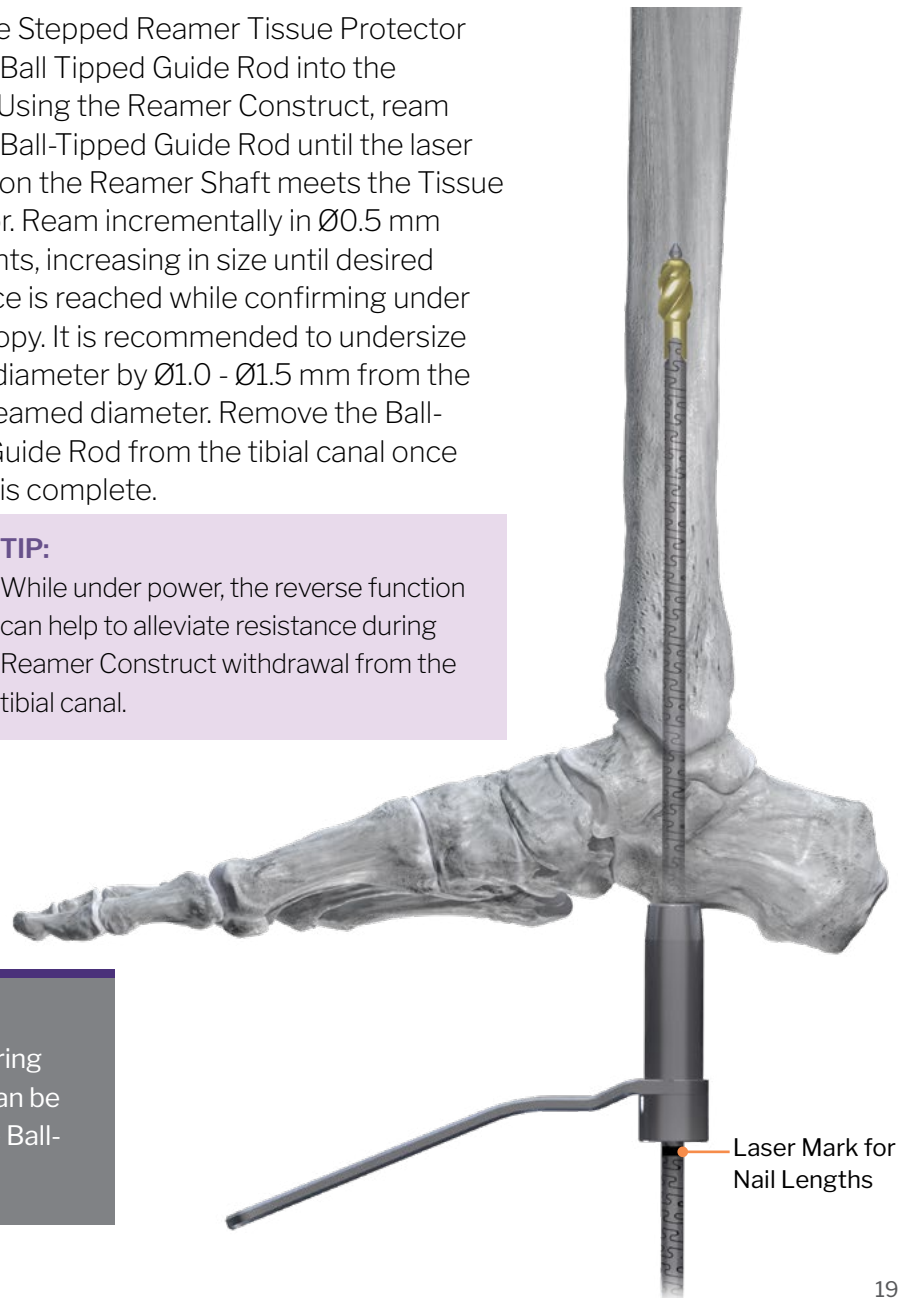

Laser Mark for Nail Lengths



**NOTE:**

While removing the Reamer Construct during incremental reaming, the Thor Hammer can be used as a stop to prevent extraction of the Ball-Tipped Guide Rod.

# NAIL ASSEMBLY

**1** Utilizing the TX-30 Driver, insert the Internal Compression Screw into the distal end of the Nail in a clockwise direction. From the posterior view of the Nail, embed the Internal Compression Screw until it is visible in the Calcaneal Window.



**2** Open the Cam Lock along the Calcaneal Guide Arm.



**3** Swing the Calcaneal Guide Arm to access the plantar end of the Outrigger. Close the Cam Lock with the Calcaneal Guide Arm in the angled position.



**NOTE:** In the first few uses, the Cam Lock may appear slightly open 10° - 15° when in the locked position. Over time and with repeated use, the Cam Lock will be flush with the Outrigger body when locked.



First uses: 10° - 15° opened



Over time: Flush

**4** Attach the Mounting Driver to the provided Handle.



# ALIGNMENT CHECK

**5** Align the prongs of the Nail to the prongs of the Outrigger. The “P” (posterior) on the Nail should align with the “P” on the Outrigger.



**6** Insert the Mounting Bolt through the plantar end of the Outrigger.



**7** Secure the Nail by placing the Mounting Driver through the plantar end of the Outrigger and turn in a clockwise direction. Once secured, confirm location of the Internal Compression Screw. If the Internal Compression Screw is inserted too far in the Calcaneal Window and may appear to interfere with the Calcaneal Peg trajectory, use the TX-30 Driver and Handle and turn counterclockwise to reposition the Internal Compression Screw.



**8** To set up the Tibial Guides, insert the Tibial Drill Guide into the Tibial Peg Guide and thread together in a clockwise direction.

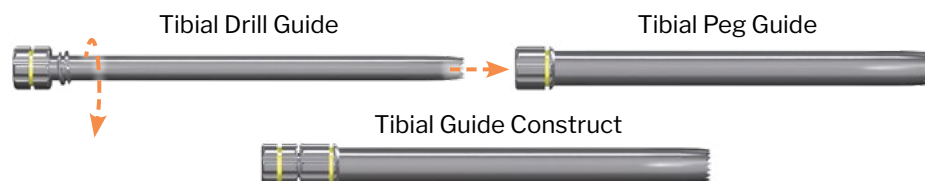

# ALIGNMENT CHECK

**9** Insert the Tibial Guide Construct medially.



**10** Insert each Tibial Guide into the applicable Tibial Threaded Peg holes, verifying choice of dynamic or static placement.

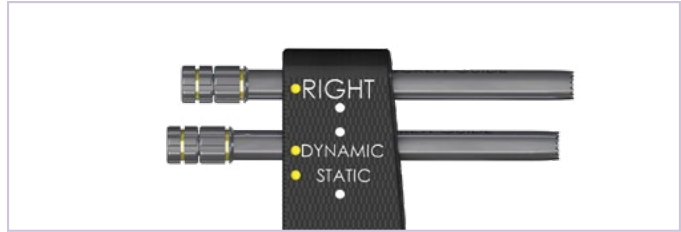

**11** Insert the Calcaneal Drill Guide into the inferior hole of the Calcaneal Peg Guide. Insert the K-wire Guide into the superior hole of the Calcaneal Peg Guide. Insert the Calcaneal Guide Construct into the Calcaneal Guide Arm of the Outrigger, with the K-wire Guide oriented superior.

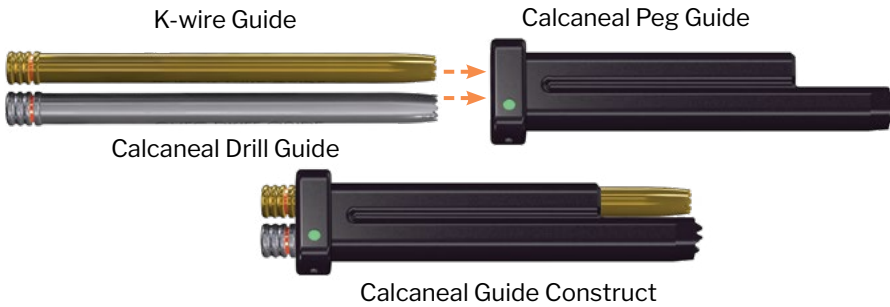

**12** Insert the Ø3.8 mm Drills into each Tibial Guide Construct to ensure that the drill passes through the hole in the Nail at the desired position. Insert the Ø4.6 mm Drill into the Calcaneal Guide Construct to ensure the Drill passes through the Nail at the desired position.

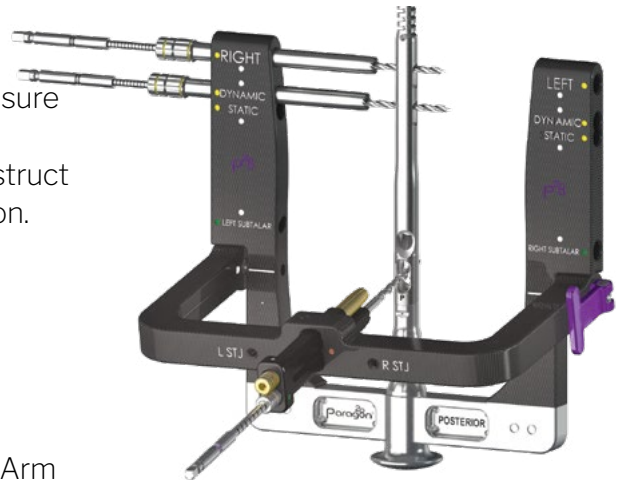

**13** Lower the Calcaneal Guide Arm. Attach the Subtalar Targeting Arm into the appropriate right or left Subtalar Threaded Peg hole on the Outrigger. Insert the Subtalar Guide Construct into the Subtalar Targeting Arm hole. Insert the Ø4.6 mm Drill to ensure that trajectory of the Subtalar Threaded Peg will be appropriate. Remove Subtalar Targeting Arm prior to presenting the Outrigger setup to the surgeon.

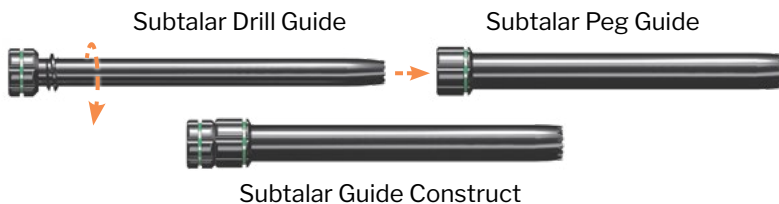

# NAIL INSERTION

Three position checks are important to ensure correct positioning of the Nail prior to Threaded Peg insertion: **Superior/Inferior Insertion Depth, Calcaneal Threaded Peg Trajectory and Nail Rotation**

## 1 SUPERIOR/INFERIOR INSERTION DEPTH

Insert the Nail and attached Outrigger into the reamed canal. Use the Thor Hammer to tap the Outrigger strike plate until the Nail is fully seated. Do not strike the Calcaneal Guide Arm. Confirm Nail size and placement using fluoroscopy.

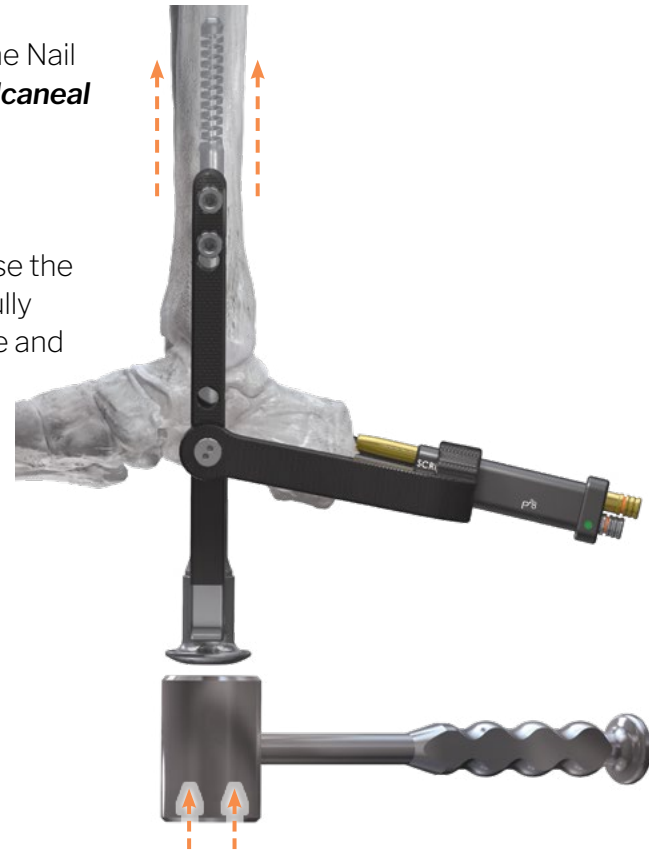
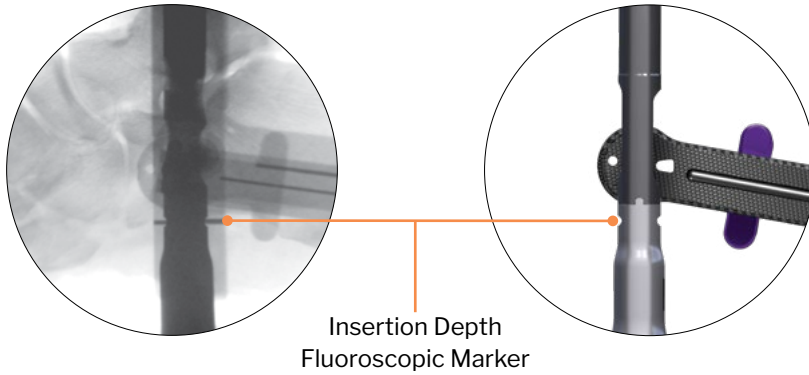

**NOTE:**

Recommended placement of the Nail is 5 mm past the plantar cortex of the calcaneus to account for intended internal compression and avoid plantar Nail prominence. An insertion depth fluoroscopic marker is located on the Outrigger to indicate 5 mm distal to the Nail end. It is recommended that this fluoroscopic marker is flush to the plantar surface of the calcaneus. If the Implant Sizer indicated that a deeper or shallower depth is necessary, adjust as needed.

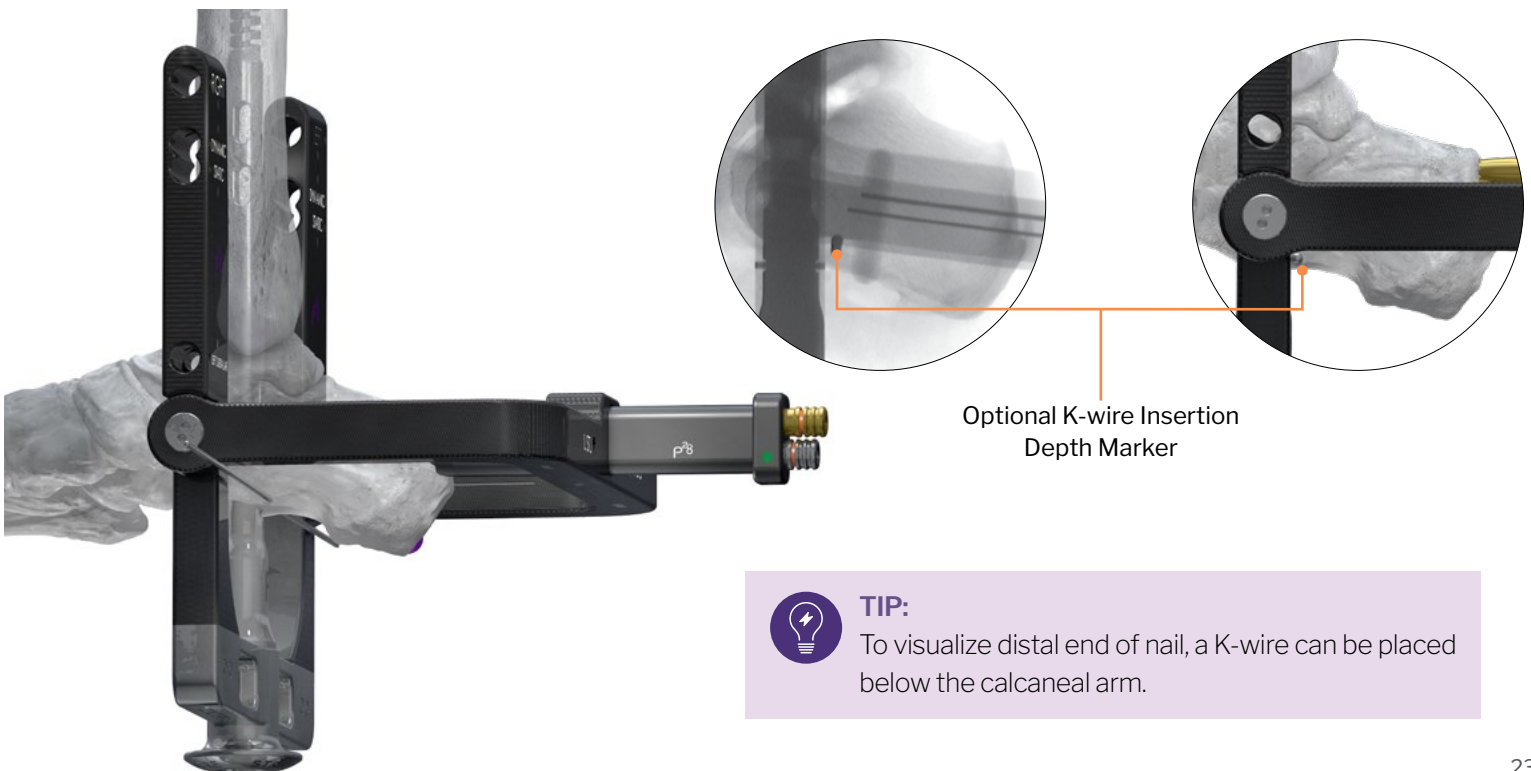

**TIP:**

To visualize distal end of nail, a K-wire can be placed below the calcaneal arm.

# NAIL INSERTION

## 2 CALCANEAL THREADED PEG TRAJECTORY

Open the Cam Lock on the Calcaneal Guide Arm and swivel the Arm superiorly into the preferred position for Threaded Peg trajectory. The 18° of adjustability is noted on the Outrigger when the white stripe on the Outrigger is within the thick white line on the Calcaneal Guide Arm. The Cam Lock will only close when the white stripe is within the thick white line, or, if viewing from the side, the white stripe must be within the angled white box. Close the Cam Lock when desired positioning is achieved.

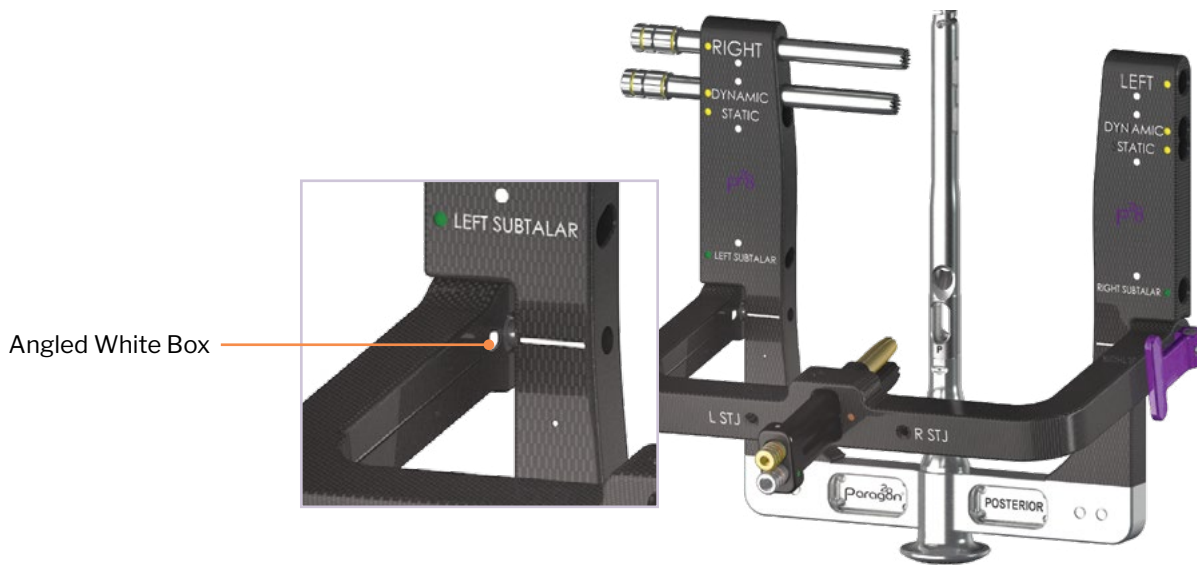
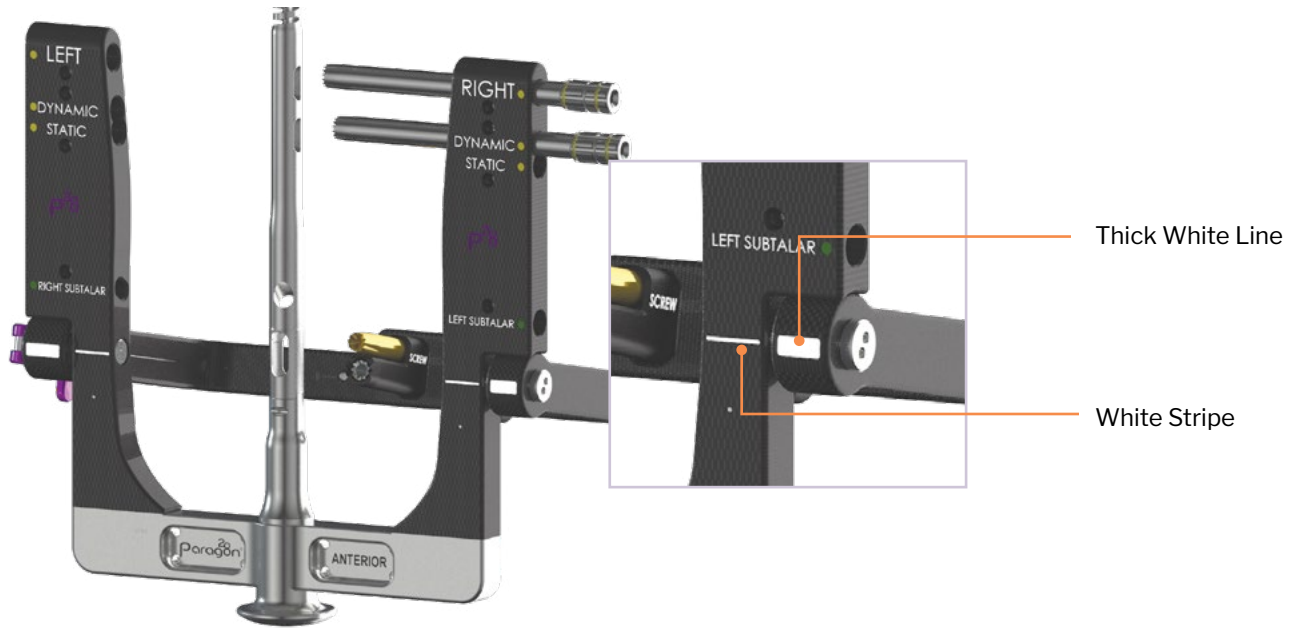



## NAIL INSERTION

### 2 CALCANEAL THREADED PEG TRAJECTORY

The Calcaneal Guide Arm on the Outrigger features two fluoroscopic inlays to help determine the appropriate Calcaneal Threaded Peg trajectory.<sup>4</sup> Align the two fluoroscopic inlays such that they are viewed as a single line to indicate a true lateral view. Assess the position of the Calcaneal Threaded Peg using the aligned fluoroscopic inlays. If the inlay alignment is not correct, open the Cam Lock and readjust the Calcaneal Guide Arm appropriately using fluoroscopy. It is recommended to centrally locate the Threaded Peg from superior to inferior at the anterior calcaneus to allow for maximum purchase in the calcaneus.

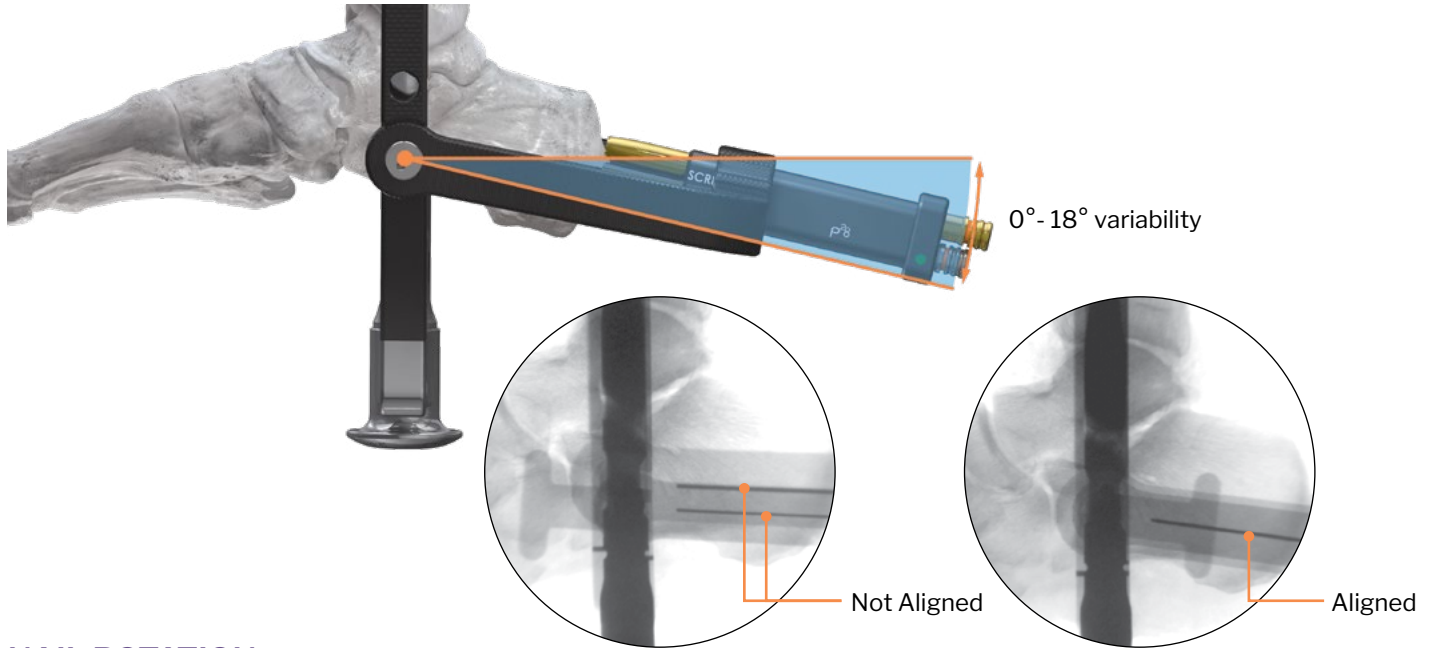

### 3 NAIL ROTATION

Review the position of the Calcaneal Guide Construct clinically with the orientation on the calcaneus. Palpate the medial edge of the calcaneus and ensure that the Calcaneal Guide Construct is just lateral to the medial edge of the calcaneus to allow for future placement of the Subtalar Threaded Peg and such that the P-A Calcaneal Threaded Peg terminates in the anterior process.



**CORRECT**

Calcaneal Threaded Peg has a more medial start point to allow for the Subtalar Threaded Peg to be 16.4° lateral to the Calcaneal Threaded Peg. This trajectory allows for both Threaded Pegs to enter the calcaneus posteriorly while achieving additional bony purchase.



**INCORRECT**

Calcaneal Threaded Peg is centered causing the Subtalar Threaded Peg start point to be too lateral.

# CALCANEAL THREADED PEG INSERTION

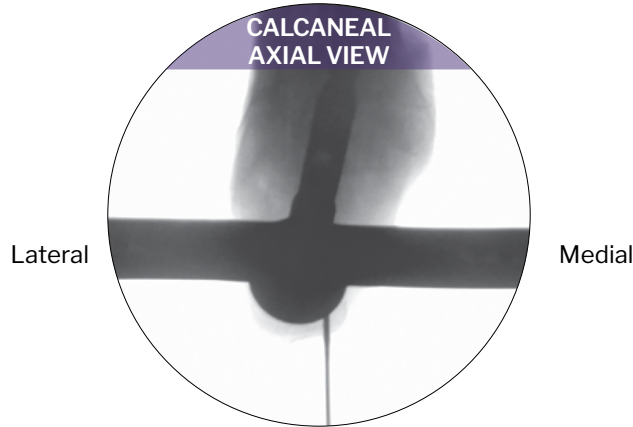

Insert a K-wire into the K-wire Guide within the Calcaneal Guide Arm in the desired position. Confirm K-wire placement and Calcaneal Threaded Peg trajectory by retracting back the Calcaneal Guide Construct and taking a calcaneal axial view using fluoroscopy.

Once appropriate K-wire position is achieved, make an approximate 1 cm incision at the projected Calcaneal Threaded Peg location, and perform blunt dissection to the bone. Adjust the Calcaneal Guide Construct to contact the posterior calcaneus. Drill into the calcaneus with the provided  $\varnothing 4.6$  mm Drill, checking termination point on lateral fluoroscopy.



Threaded Peg length can be measured using the markings on the  $\varnothing 4.6$  mm Drill while in the Calcaneal Guide Construct. If measuring Calcaneal Threaded Peg depth from the Drill, round the measurement down to the nearest whole number.



## NOTE:

Alternatively, Threaded Peg length can be measured by removing the Calcaneal Drill Guide from the Calcaneal Guide Construct. Insert the Solid Depth Gauge into the Calcaneal Guide Construct to measure Threaded Peg length.

## CALCANEAL THREADED PEG INSERTION

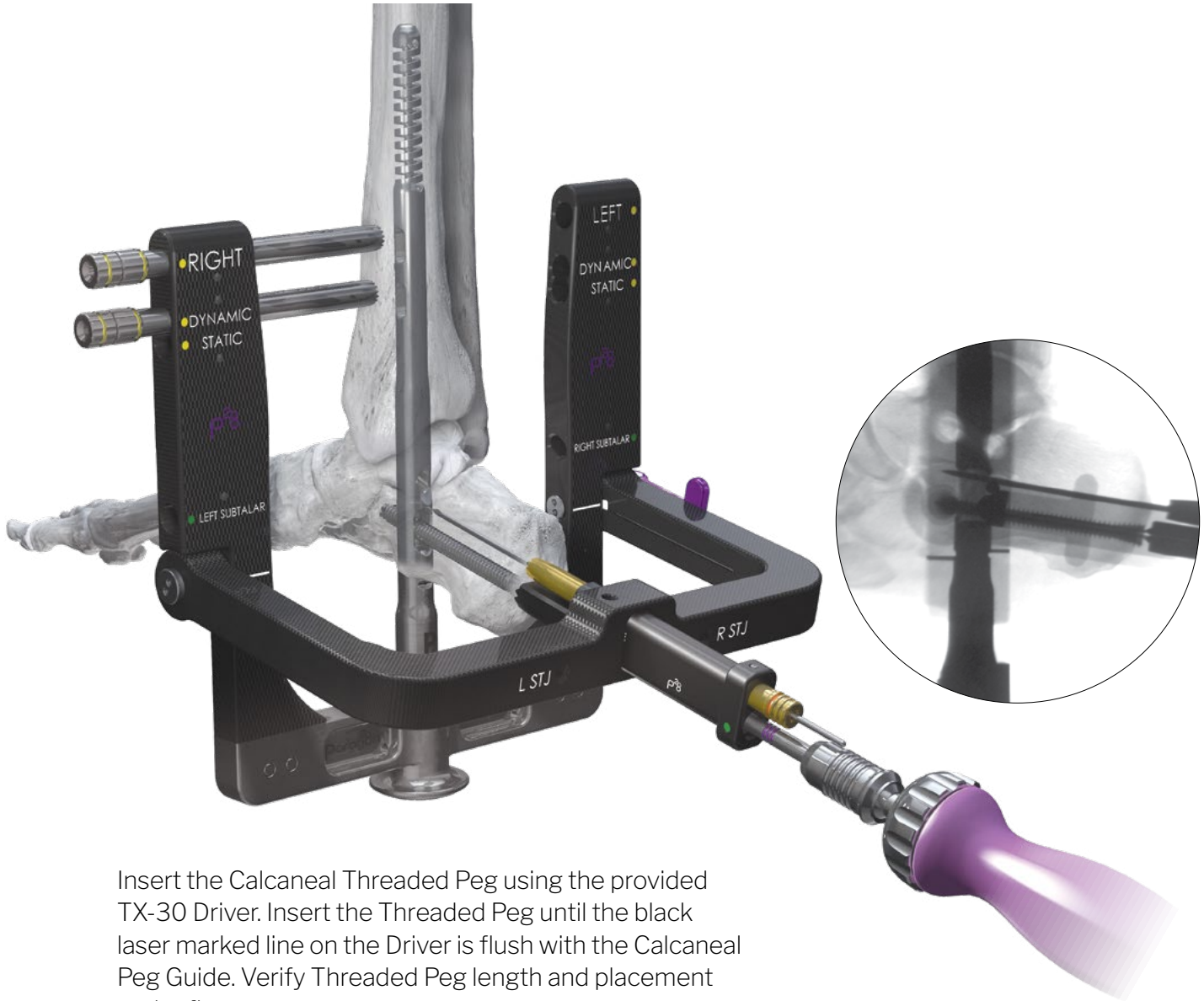

Insert the Calcaneal Threaded Peg using the provided TX-30 Driver. Insert the Threaded Peg until the black laser marked line on the Driver is flush with the Calcaneal Peg Guide. Verify Threaded Peg length and placement under fluoroscopy.

## TIBIAL THREADED PEG INSERTION

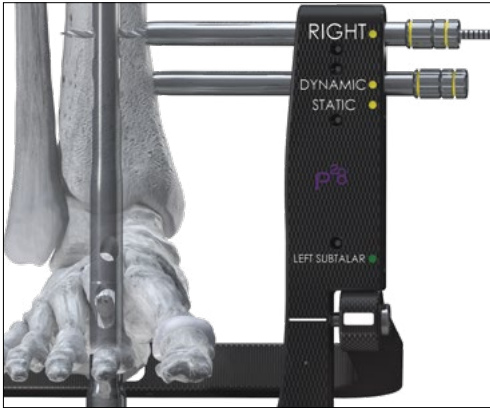

Ensure that the Tibial Drill Guides are positioned for desired initial set-up (static versus dynamic configuration). Make a small stab incision at the proximal Tibial Guide Construct. Perform blunt dissection and adjust Drill Guide construct to abut bone. Drill bicortically, from the medial to lateral direction, through the Tibial Drill Guide using the Ø3.8 mm drill.

Threaded Peg depth can be measured from the Drill with the Drill Guide in place and/or using the Solid Depth Gauge after removal of the Drill Guide. When measuring Tibial Threaded Peg depth, round the measurement up to the nearest whole number.



### NOTE:

If measuring Threaded Peg depth off of the Solid Depth Gauge, ensure the Drill Guide is touching the bone and the drill tip is reaching the lateral edge. If measuring Threaded Peg depth off of the Solid Depth Gauge, ensure the Drill Guide is touching the bone and the Solid Depth Gauge is grabbing the lateral cortex.

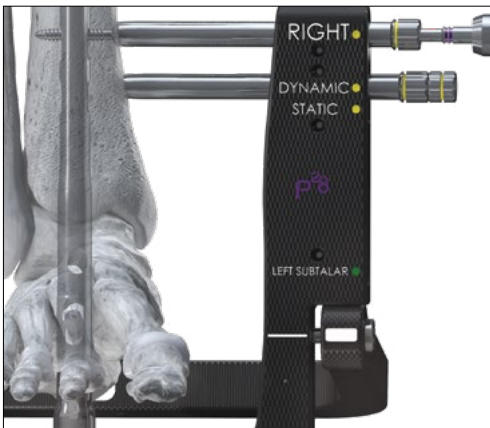

Once the Tibial Drill Guide is removed, insert the appropriately sized Threaded Peg through the Tibial Peg Guide and into the Nail using the long TX-20 Driver and handle, turning in a clockwise direction until the laser mark on the Driver meets the end of the Tibial Peg Guide, or when the head of the Threaded Peg is snug against the tibia.



Verify the Threaded Peg length and placement under fluoroscopy. Repeat the steps above to place the second Tibial Threaded Peg in the dynamic hole.



### NOTE:

Ensure that the Tibial Threaded Pegs do not violate the fibula on fluoroscopy.

## TIBIAL THREADED PEG INSERTION

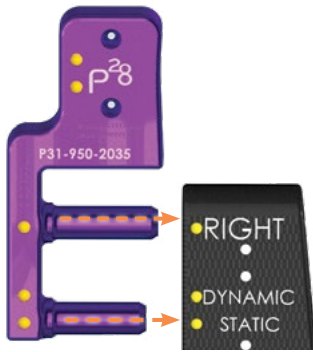

Without Tibial Guide Construct

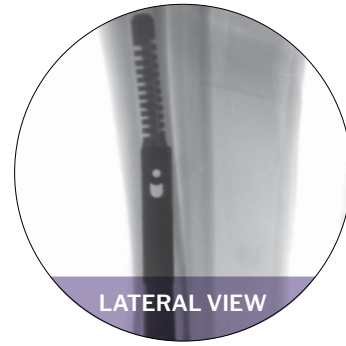

With Tibial Guide Construct



Phantom ActivCore™ Nails measuring 250 mm or greater in length provide a 3<sup>rd</sup> Tibial Threaded Peg hole. The Proximal Guide Arm is provided to insert the most proximal Tibial Threaded Peg. To attach, insert the Proximal Guide Arm into the most proximal medial tibial arm slot on the Outrigger.

Insert the Tibial Guide Construct into the Proximal Guide Arm, using either the dynamic or static configuration to achieve constant compression. Using a lateral fluoroscopic view, ensure that the Tibial Guide Construct is centered over the most proximal Nail slot.

Repeat the steps previously described to insert the Tibial Threaded Peg.

## INTERNAL COMPRESSION



To compress the Nail through the Internal Compression Screw, swing the Calcaneal Guide Arm away from the Outrigger strike plate. Insert the TX-30 Driver into the plantar portion of the Nail through the Outrigger. Turn the Driver clockwise until optimal compression is achieved. The Internal Compression Screw will translate proximally to enter the Calcaneal Window and apply pressure to the Calcaneal Threaded Peg.



**NOTE:**

Every full turn of the Driver is 0.5 mm of compression, with the ability to travel up to 8 mm (or 16 turns).

## SUBTALAR THREADED PEG INSERTION

Open the Cam Lock adjacent to the Calcaneal Guide Arm on the Outrigger. Move the Calcaneal Guide Arm inferiorly to align with the inferior aspect of the Outrigger. Insert the Subtalar Guide Arm in the appropriate right (R) or left (L) subtalar hole (STJ) on the Outrigger. When correctly inserted, The Subtalar Guide Arm will provide an audible click.



**NOTE:**

Ensure that the Subtalar Guide Arm is fully inserted into the Outrigger by visualizing the Black Laser Mark of the Subtalar Guide Arm on the interior side of the Outrigger.

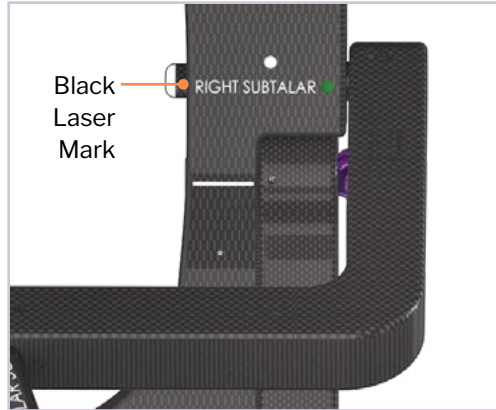

**CORRECT**

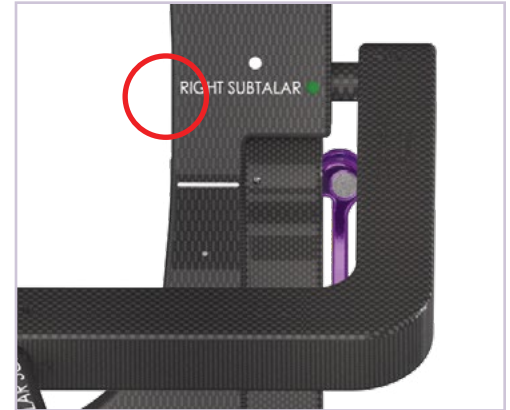

**INCORRECT**

Insert the Subtalar Guide Construct into the Subtalar Guide Arm.

Make a stab incision at the location of the Subtalar Guide Construct and perform blunt dissection to bone. Adjust the Subtalar Guide Construct to abut bone. Drill into the calcaneus and talus with the Ø4.6 mm Solid Drill. Measure the Threaded Peg length off of the laser marking on the Ø4.6 mm Solid Drill, or remove the Subtalar Drill Guide and insert the Solid Depth Gauge into the Subtalar Peg Guide to measure Threaded Peg length.

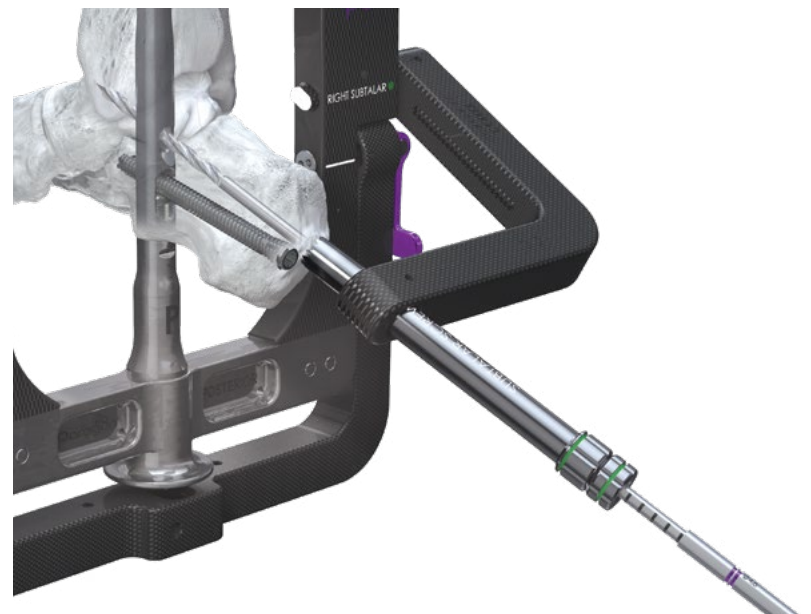

Insert the appropriately sized Subtalar Threaded Peg through the Nail using the technique previously described for Threaded Peg insertion in the calcaneus, using the TX-30 Driver and Handle.

Verify Threaded Peg length and position under fluoroscopy.

## OPTIONAL: SUBTALAR MONSTER® SCREW PLACEMENT OUTSIDE OF PHANTOM® TTC NAIL

If the trajectory of the Subtalar Threaded Peg through the Nail is not conducive to patient anatomy, or if an additional screw outside of the Nail is desired for stability, a Ø4.5 mm, Ø5.5 mm or Ø7.0 mm Monster Hindfoot Screw can be inserted through an external guide (Home Run Screw Arm) to avoid interference with the Nail and Calcaneal Threaded Peg. Insert the Home Run Screw Arm into the left or right subtalar hole (STJ) on the Outrigger. Insert the K-wire Guide for the selected Monster Screw diameter into the desired hole in the Home Run Screw Arm.

### MONSTER HINDFOOT SCREW OFFERING

<b>SCREW DIAMETER</b>	Ø4.5 mm	Ø5.5 mm	Ø7.0 mm
<b>K-WIRE DIAMETER</b>	Ø1.4 mm	Ø1.6 mm	Ø2.3 mm
<b>DRILL SIZE</b>	Ø2.9 mm	Ø3.5 mm	Ø4.6 mm
<b>DRIVER</b>	TX-15	TX-25	TX-30

Remove the K-wire Guide, and slide the Home Run Screw Arm off of the K-wire and Outrigger.

If using a headed Monster Screw (shown), utilize the headed Countersink. Rotate the Countersink clockwise over the K-wire to remove adequate bone to seat the Screw head. Measure Screw length using the cannulated Depth Gauge. If using a headless Monster Screw, measure Screw length using the cannulated Depth Gauge prior to using the headless Countersink for the headless Monster Screw.

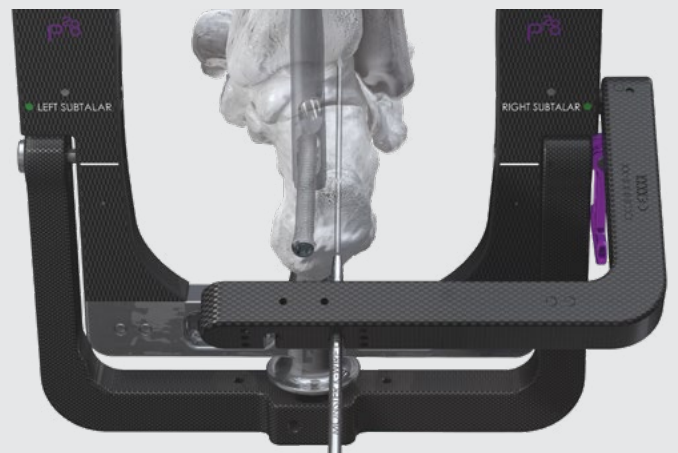

## OPTIONAL: SUBTALAR MONSTER® SCREW PLACEMENT OUTSIDE OF PHANTOM® TTC NAIL

Open the Cam Lock adjacent to the Calcaneal Guide Arm on the Outrigger. Move the Calcaneal Guide Arm inferiorly to align with the inferior aspect of the Outrigger. Insert the Subtalar Targeting Arm in the appropriate right (R) or left (L) subtalar hole on the Outrigger.



Drill over the K-wire using the Drill for the selected headed Monster Screw.

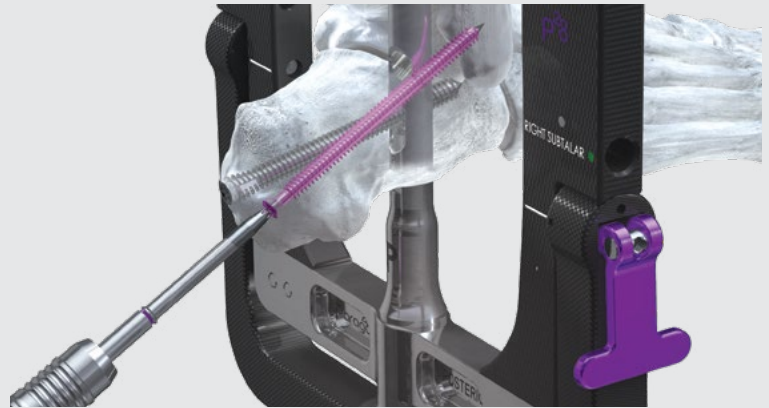

Insert a headed Monster Screw using the provided Driver. Confirm Screw length and placement using fluoroscopy.

## OUTRIGGER REMOVAL

Verify Nail and Threaded Peg placement under multiple fluoroscopic views. Using the bolt Driver attachment and Handle, turn counterclockwise until the Outrigger is released from the Nail.

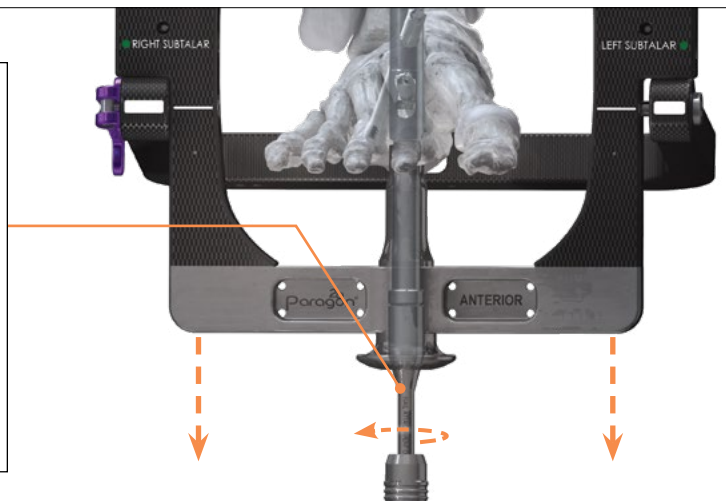

## END CAP PLACEMENT

Secure the selected End Cap to the Nail using the short TX-30 Driver in a clockwise direction until the End Cap is secure. Bony in growth may occur if an end cap is not used, making implant removal more difficult.



### NOTE:

Alternatively, a  $\varnothing 2.3$  mm K-wire can be used as a guide into the distal part of the Nail, with the End Cap placed over the K-wire, to allow for centering of the End Cap prior to threading into position.

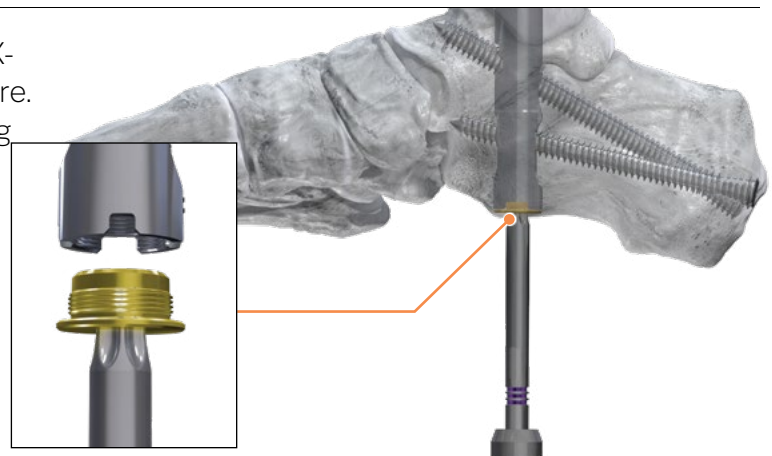

## CLOSURE

Proceed to incision closure or concomitant procedures at this time.



## IMPLANT REMOVAL

**NOTE:** It is recommended to clean out the plantar nail threads with a soft bristle brush and saline to remove in growth and soft tissue before attempting to insert explant attachment.

Attach the TX-30 Driver to the appropriate Handle. Using fluoroscopy, locate the plantar insertion point of the Nail, and make a small incision. If an end cap was implanted, insert the TX-30 Driver into the end cap and rotate counterclockwise to remove. If no end cap was implanted, insert the TX-30 Driver into the Internal Compression Screw and rotate counterclockwise to remove.

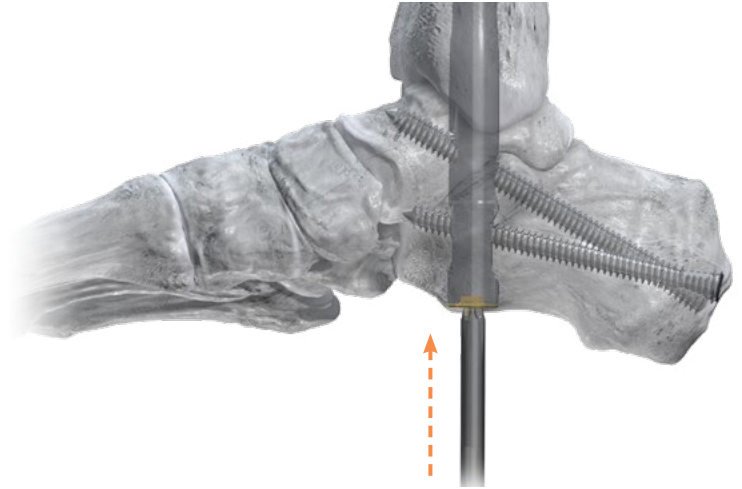

Attach the Explant Attachment onto the Slap Hammer to create the Slap Hammer Construct.

Attach the Slap Hammer Construct to the Nail by rotating the Slap Hammer in a clockwise direction into the plantar portion of the Nail.

**NOTE:** The Explant Attachment can be threaded into the nail before connecting the slap hammer for ease of centering and positive feedback.

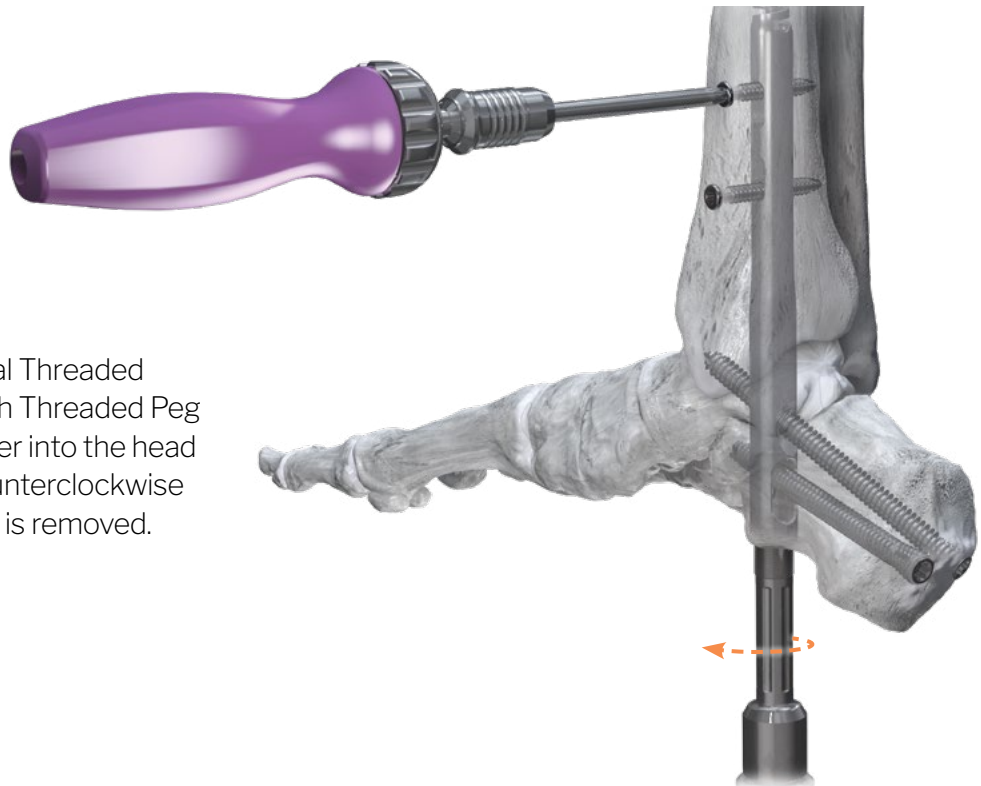

Using fluoroscopy, locate the Tibial Threaded Pegs. Make a small incision at each Threaded Peg location and insert the TX-20 Driver into the head of the Threaded Peg. Turn in a counterclockwise direction until each Threaded Peg is removed.

## IMPLANT REMOVAL

Utilizing the same TX-30 Driver and Handle construct as described above, remove the Subtalar Threaded Peg and Calcaneal Threaded Peg. Confirm removal of all Threaded Pegs, using fluoroscopy prior to attempting to remove the Phantom<sup>®</sup> TTC Nail.



Use the sliding mechanism of the Slap Hammer to back the Nail out of the foot in an inferior direction until the Nail is removed.

**NOTE:**

In some cases, the nail needs to be rotated in the canal before removal to break apart any bony in growth.

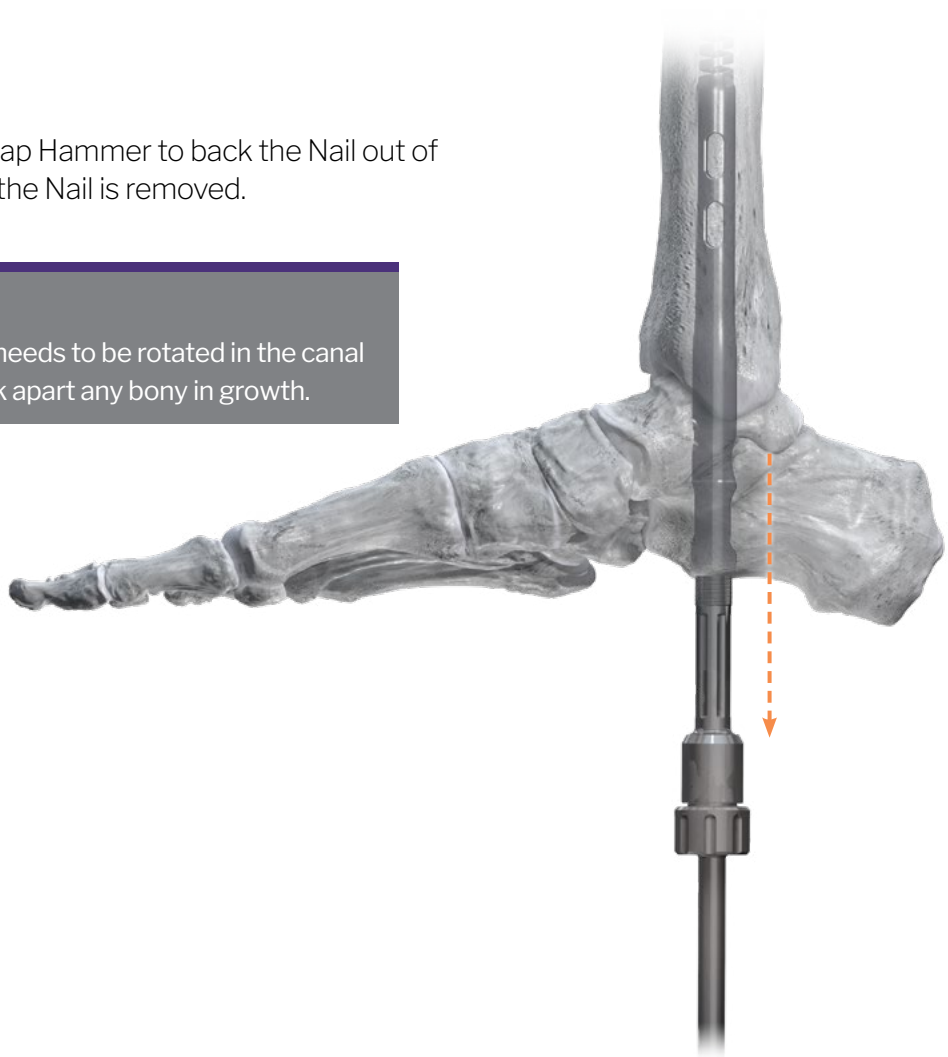



**CASE 1**

The PRECISION® Guide, Parallel Offset Guide, Implant Sizer, Stepped Reamer, Entry Drill, Tissue Protectors, K-wires, and joint preparation instrumentation including Curettes, Osteotomes, Chisels, and a Honeybadger are located within Case 1.

**CASE 2**

The Reamer Heads, Flexible Reamer Shafts, Ball-Tipped Guide Rod, Ghost™ Outrigger, Drill Guides, Threaded Peg Guides, K-wire Guides, and a Hindfoot Distractor are located within Case 2.

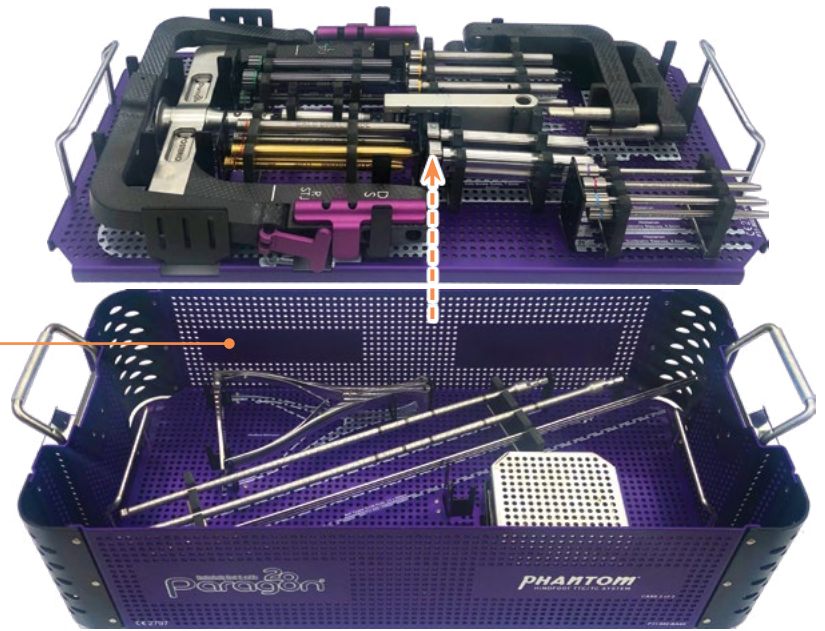

**CASE 3**

The Threaded Pegs, End Caps, Drivers, Driver Attachments, Handles, Drills, Depth Gauges, Thor Hammer, Slap Hammer, and Explant Attachment are located within Case 3

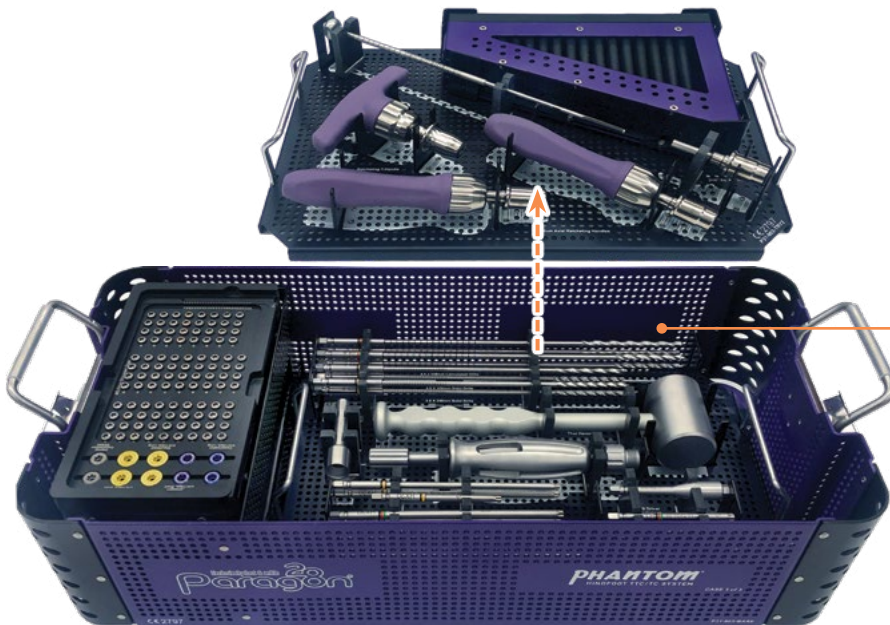

Refer to [www.paragon28.com/ifus](http://www.paragon28.com/ifus) for the complete and most current instructions for use document.

### INDICATIONS FOR USE (PHANTOM<sup>®</sup> HINDFOOT TTC/TC NAIL SYSTEM)

The Phantom<sup>®</sup> Hindfoot TTC/TC Nail System is intended for tibiotalocalcaneal arthrodesis (fusion) and to provide stabilization of the hindfoot and ankle including the transverse tarsal joints coupling the mid-foot to the hindfoot. Examples of specific indications include:

- Post-traumatic or degenerative arthritis
- Previously infected arthrosis
- Revision of failed ankle arthrodesis
- Revision of failed total ankle arthroplasty
- Talar deficiency conditions such as avascular necrosis of the talus (requiring tibiocalcaneal arthrodesis)
- Neuromuscular deformity or other neuromuscular disease with severe deformity or instability of the ankle
- Rheumatoid arthritis
- Osteoarthritis
- Nonunions or pseudarthrosis of hindfoot and distal tibia
- Trauma (severe or malunited tibial pilon fracture)
- Charcot foot (neuroarthropathy)
- Severe end-stage degenerative arthritis
- Instability and skeletal defects after tumor resection
- Pantalar arthrodesis
- Severe foot/ankle deformity

### CONTRAINDICATIONS

The Paragon 28<sup>®</sup> Phantom<sup>®</sup> Hindfoot TTC/TC Nail System implants are not designed or sold for any use except as indicated. Use of the Phantom<sup>®</sup> Hindfoot TTC/TC Nail System is contraindicated in the following situations:

- Active, suspected or latent infection in the affected area
- Patients who are physiologically or psychologically inadequate Corpulence; an overweight or corpulent patient can strain the implant to such a degree that stabilization or implant failure can occur
- Patients previously sensitized to titanium
- Longitudinal splits, fractures, or deformities
- Insufficient quantity or quality of bone to permit stabilization, conditions that retard healing (not including pathological fractures) and conditions causing poor blood supply
- Open epiphyseal plates
- Patients with an insufficient plantar fat pad
- Patients with an intact asymptomatic subtalar joint
- Patients with significant tibial malalignment (>10 degrees in either sagittal or coronal plane)
- In patients where there is a possibility for conservative treatment
- Indications not included in the **INDICATIONS FOR USE**

### POTENTIAL COMPLICATIONS AND ADVERSE REACTIONS

In any surgical procedure, the potential for complications and adverse reactions exist. The risks and complications with these implants include:

- Loosening, deformation or fracture of the implant
- Acute post-operative infections and late infections with possible sepsis
- Migration, subluxation of the implant with resulting reduction in range of movement
- Fractures resulting from unilateral joint loading
- Thrombosis and embolism
- Wound hematoma and delayed wound healing
- Temporary and protracted functional neurological perturbation
- Tissue reactions as a result of allergy or foreign body reaction to dislodged particles
- Corrosion with localized reaction and pain
- Pain, a feeling of malaise or abnormal sensations due to the implant used
- Bone loss due to stress shielding
- Loss of fixation in bone attributable to nonunion, osteoporosis and/or markedly unstable comminuted fractures
- Nonunion or malunion with rotation or angulation resulting in limb shortening or loss of anatomic positioning
- Irritation of soft tissues, including impingement syndrome

All possible complications listed here are not typical of Paragon 28<sup>®</sup>, Inc. products but are in principle observed with any implant. Promptly inform Paragon 28<sup>®</sup>, Inc. as soon as complications occur in connection with the implants or surgical instruments used. In the event of premature failure of an implant in which a causal relationship with its geometry, surface quality or mechanical stability is suspected, please provide Paragon 28<sup>®</sup>, Inc. with the explant(s) in a cleaned, disinfected and sterile condition. Paragon 28<sup>®</sup>, Inc. cannot accept any other returns of used implants. The surgeon is held liable for complications associated with inadequate asepsis, inadequate preparation of the osseous implant bed in the case of implants, incorrect indication or surgical technique or incorrect patient information and consequent incorrect patient behavior.

### WARNINGS AND PRECAUTIONS

- Re-operation to remove or replace implants may be required at any time due to medical reasons or device failure. If corrective action is not taken, complications may occur.
- Use of an undersized implant in areas of high functional stresses may lead to implant fracture and failure.
- Implants, wires, or other appliances of dissimilar metals should not be used together in or near the implant site.
- The implants and guide wires are intended for single use only.
- Instruments, guide wires and screws are to be treated as sharps.
- **Do not use other manufacturer's instruments or implants in conjunction with the Phantom<sup>®</sup> Hindfoot TTC/TC Nail System**
- **Do not resterilize the Phantom<sup>®</sup> Hindfoot TTC/TC Nail**

Refer to [www.paragon28.com/ifus](http://www.paragon28.com/ifus) for the complete and most current instructions for use document.

## MR SAFETY INFORMATION



A patient with the Paragon 28® Phantom® Hindfoot TTC/TC Nail may be safety scanned under the following conditions. Failure to follow these conditions may result in injury to the patient.

NAME/IDENTIFICATION OF DEVICE	PARAGON 28® PHANTOM® HINDFOOT TTC/TC NAIL
Nominal value(s) of Static Magnetic Field [T]	1.5 T or 3T
Maximum Spacial Field Gradient [T/m and gauss/cm]	30 T/m (3000 gauss/cm)
RF Excitation	Circularly Polarized (CP)
RF Transmit Coil Type	Whole body transmit coil, Head RF trasnmit-receive coil
Maximum Whole Body SAR [W/kg]	2.0 W/kg
Limits on Scan Duration	2.0 W/kg whole body average SAR for 14 minutes of continuous RF (a sequence or back to back series/scan without breaks)
MR Image Artifact	The presence of this implant may product an image artifact of 23 mm.

If information about a specific parameter is not included, there are no conditions associated with that parameter.

Refer to [www.paragon28.com/ifus](http://www.paragon28.com/ifus) for the complete and most current instructions for use document.

### INDICATIONS FOR USE (MONSTER<sup>®</sup>)

The Monster<sup>®</sup> Screw System is indicated for use in bone reconstruction, osteotomy, arthrodesis, joint fusion, ligament fixation, fracture repair and fracture fixation of the foot and ankle, including the tibia, fibula, tarsus, metatarsals, and phalanges and the joints and ligaments coupling said bones, appropriate for the size of the device.

### CONTRAINDICATIONS

Use of the Monster<sup>®</sup> Screw System is contraindicated in cases of inflammation, cases of active or suspected sepsis / infection and osteomyelitis; or in patients with certain metabolic diseases.

All applications that are not defined by the indications are contraindicated. In addition, surgical success can be adversely affected by:

- Acute or chronic infections, local or systemic
- Vascular, muscular or neurological pathologies that compromise the concerned extremity
- All concomitant pathologies that could affect the function of the implant
- Osteopathies with reduced bone substance that could affect the function of the implant
- Any mental or neuromuscular disorder that could result in an unacceptable risk of failure at the time of fixation or complications in post-operative treatment
- Known or suspected sensitivity to metal
- Corpulence; an overweight or corpulent patient can strain the implant to such a degree that stabilization or implant failure can occur
- Whenever the use of the implant comes into conflict with the anatomical structures of physiological status

Other medical or surgical pre-conditions that could compromise the potentially beneficial procedure, such as:

- The presence of tumors
- Congenital abnormalities
- Immunosuppressive pathologies
- Increased sedimentation rates that cannot be explained by other pathologies
- Increased leukocyte (WBC) count
- Pronounced left shift in the differential leukocyte count

### POTENTIAL COMPLICATIONS AND ADVERSE REACTIONS

In any surgical procedure, the potential for complications and adverse reactions exist. The risks and complications with these implants include:

- Loosening, deformation or fracture of the implant
- Acute post-operative wound infections and late infections with possible sepsis
- Migration, subluxation of the implant with resulting reduction in range of movement
- Fractures resulting from unilateral joint loading
- Thrombosis and embolism
- Wound hematoma and delayed wound healing
- Temporary and protracted functional neurological perturbation
- Tissue reactions as the result of allergy or foreign body reaction to dislodged particles.
- Corrosion with localized tissue reaction and pain
- Pain, a feeling of malaise or abnormal sensations due to the implant used
- Bone loss due to stress shielding

All possible complications listed here are not typical of Paragon 28<sup>®</sup>, Inc. products but are in principle observed with any implant. Promptly inform Paragon 28<sup>®</sup> as soon as complications occur in connection with the implants or surgical instruments used. In the event of premature failure of an implant in which a causal relationship with its geometry, surface quality or mechanical stability is suspected, please provide Paragon 28<sup>®</sup> with the explant(s) in a cleaned, disinfected and sterile condition. Paragon 28<sup>®</sup> cannot accept any other returns of used implants. The surgeon is held liable for complications associated with inadequate asepsis, inadequate preparation of the osseous implant bed in the case of implants, incorrect indication or surgical technique or incorrect patient information and consequent incorrect patient behavior.

### WARNINGS AND PRECAUTIONS

- Re-operation to remove or replace implants may be required at any time due to medical reasons or device failure. If corrective action is not taken, complications may occur.
- Use of an undersized screw in areas of high functional stresses may lead to implant fracture and failure.
- Plates and screws, wires, or other appliances of dissimilar metals should not be used together in or near the implant site.
- The implants and guide wires are intended for single use only. Re-use may cause product failure and could lead to disease transmission.
- Instruments, guide wires and screws are to be treated as sharps.
- **Do not use other manufacturer's instruments or implants in conjunction with the Monster<sup>®</sup> Screw System.**

### MR SAFETY INFORMATION

The Monster<sup>®</sup> Screw System has been evaluated for safety and compatibility in the MR environment. It has not been tested for heating, migration or image artifact in the MR environment. The safety of the Monster<sup>®</sup> Screw System in the MR Environment is unknown. Scanning a patient who has this device may result in patient injury.



# PHANTOM<sup>®</sup>

## HINDFOOT TTC SYSTEM

PATENTED, DESIGNED & EXCLUSIVELY DISTRIBUTED BY

Exclusively foot & ankle **28**  
**Paragon**<sup>®</sup>

P31-STG-3001 RevD [02-03-2023]

™Trademarks and ®Registered Marks of Paragon 28®, Inc.

© Copyright 2023 Paragon 28®, Inc. All rights reserved.

Patents: [www.paragon28.com/patents](http://www.paragon28.com/patents)

Paragon 28, Inc.   
14445 Grasslands Dr.  
Englewood, CO 80112 USA  
(855) 786-2828

**Australian Sponsor**  
Emergo Australia  
201 Sussex Street  
Level 20, Tower II, Darling Park  
Sydney, NSW 2000 Australia

1. Internal Test Report TR-19121202
2. Whitten, "Evaluation of the Effects of Anodization on the Fatigue Performance of Titanium Alloy," in Fatigue and Fracture Metallic Medical Materials and Devices, ed. M. Mitchell, S. Smith, T. Woods, and B. Berg (West Conshohocken, PA: ASTM International, 2013), 109-121.
3. Papa JA, et al. Pantalar and tibiotalar calcaneal arthrodesis for the post-traumatic osteoarthritis of the ankle and hindfoot. J Bone Joint Surg Am. 1992; 74: 1042-1049.
4. Internal Test Report TR-20010701

### DISCLAIMER

The purpose of the Phantom® TTC Nail System Surgical Technique Guide is to demonstrate the optionality and functionality of the Phantom® TTC Nail System. Although variations in placement and use of the Phantom® TTC Nail System can be performed, the fixation options demonstrated in this technique were chosen to demonstrate the functionality of the system and for simplicity of explanation. Other uses for the Phantom® TTC Nail System can be employed, appropriate for the size of the device. Federal law (U.S.A.) restricts this device to sale and use by, or on order of, a physician.

[www.Paragon28.com](http://www.Paragon28.com)