

FASTRAC™
DISTAL TIBIA ALIGNMENT SYSTEM

SURGICAL TECHNIQUE GUIDE
WITH LASER ALIGNMENT VERIFICATION

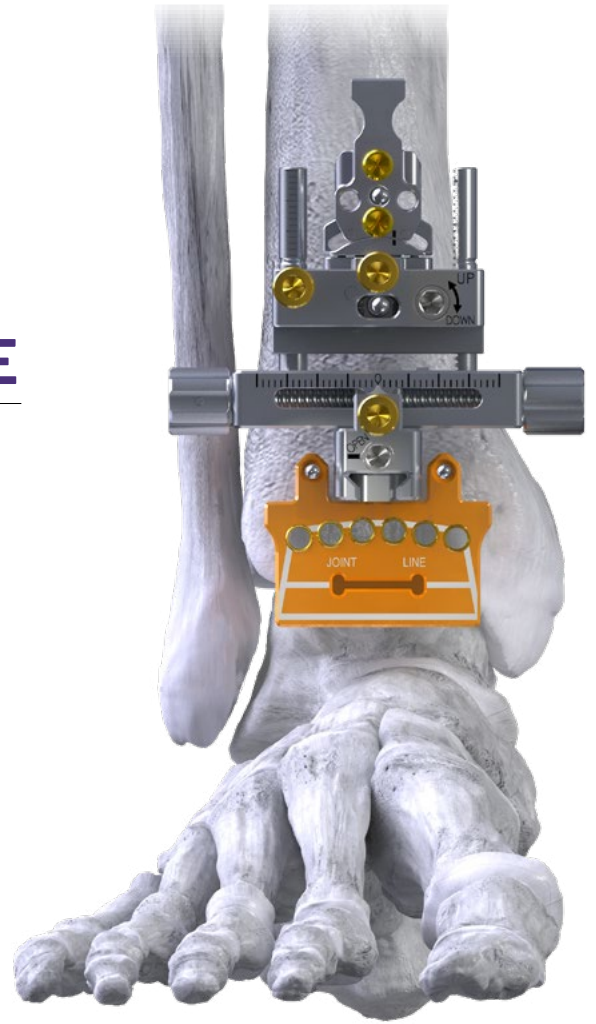
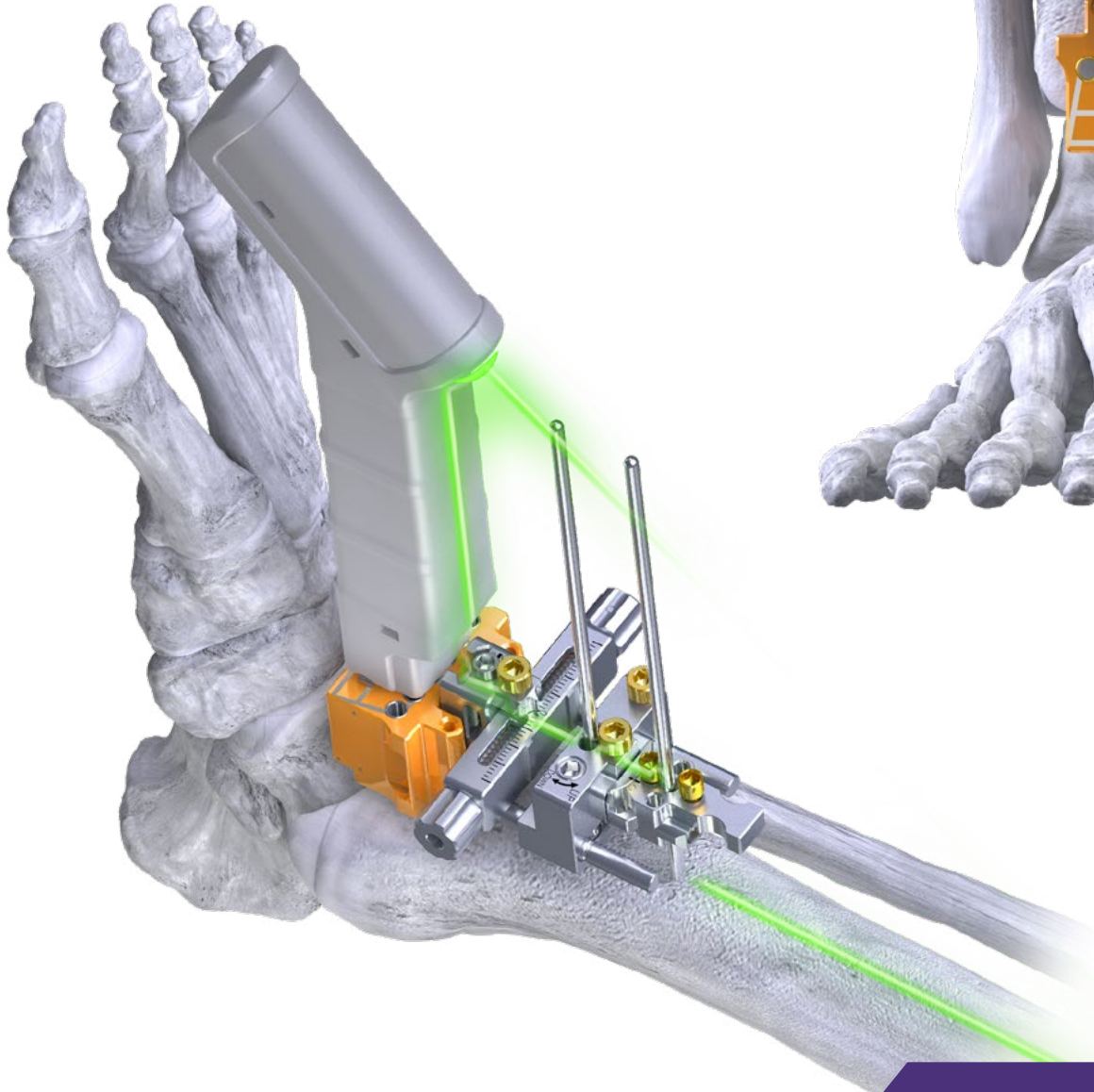

ALIGNMENT REDEFINED.

PRODUCT INFORMATION

The Paragon 28® APEX 3D™ Optical Alignment Verification Laser was developed to provide a targeted visual reference point during alignment confirmation. The device can be utilized with the APEX 3D Total Ankle Replacement System’s alignment components, including, but not limited to FasTrac™ Distal Tibia Alignment System’s instrumentation.

The FasTrac™ alignment construct consists of a Varus / Valgus ShortStack Alignment Guide paired with the Distal Control Body of the APEX 3D Total Ankle Replacement System’s Traditional Alignment Guide.

The APEX 3D Total Ankle Replacement System is indicated for total ankle replacement in primary or revision surgery for patients with ankle joints damaged by severe rheumatoid, post-traumatic, or degenerative arthritis.

The Paragon 28® APEX 3D Total Ankle Replacement System is a fixed bearing device comprised of a tibial component, a talar component and a Vitamin E Ultra-High Molecular Weight Polyethylene component. Implants are available in varying sizes and design configurations intended for both primary and revision applications. For additional information regarding Indications for Use, Contraindications, Warnings, Precautions, etc. please visit: <https://www.paragon28.com/ifus/>

CONTENTS

SECTION 1

SURGICAL TECHNIQUE:

Approach & Soft Tissue Preparation 3

Back-Table:Instrument Overview 4-5

SECTION 2

Alignment Guide Positioning & Micro Adjustments

Gross Alignment & Establishing Slope 6

Internal / External Alignment 7-8

Micro Adjustments: Varus / Valgus 9

Micro Adjustments: Joint Line Height, Medial/Lateral, Sizing 10

AP Sizing Confirmation..... 12-13

Lock Final Position 14

APPENDIX A

Instruction for Use (IFU) & Contraindications, Warnings, Precautions 15-17

DESIGN TEAM

Mark Dalton, MD – Austin, TX

Jeffrey Christensen, DPM – Everett, WA

Michael Houghton, MD – Fort Collins, CO

Mark Myerson, MD – Denver, CO

ACKNOWLEDGMENTS:

Contributing Surgeon Advisors, Paragon 28’s Development Engineers, Clinical Researchers and Marketing Teams.

ANTERIOR SURGICAL APPROACH

EXPOSURE

- A longitudinal midline incision is made over the anterior ankle, beginning approximately 7 cm proximal to the ankle joint and terminating at approximately or just distal to the talonavicular joint.
- Care should be taken to avoid excess retraction on the skin margins and full thickness retraction is performed, when possible, to protect the extensor tendons and neurovascular structures.
- After the initial skin incision, deepen through the subcutaneous tissue. The superficial peroneal nerve (SPN) is identified and protected in distal extension to avoid injury.
- Identify the extensor retinaculum and incise between the anterior tibia and EHL tendon, preserving as much of their respective sheaths as possible.
- Retract the anterior tibia tendon and it's respective sheath medially and the EHL and it's sheath laterally. Take care to avoid injury to the underlying neurovascular structures laterally.
- A longitudinal capsulotomy is performed creating medial and lateral capsular flaps, which are elevated and reflected. This exposes the anterior ankle joint, medial and lateral gutters, and dorsal talar neck.



DISTAL TIBIA PREPARATION

- If necessary, remove marginal tibiotalar osteophytes from the anterior ankle which may impede instrumentation entry and placement.
- If excessive talar bossing or spurs are noted, it is recommended that the prominence is resected to normalize contour.

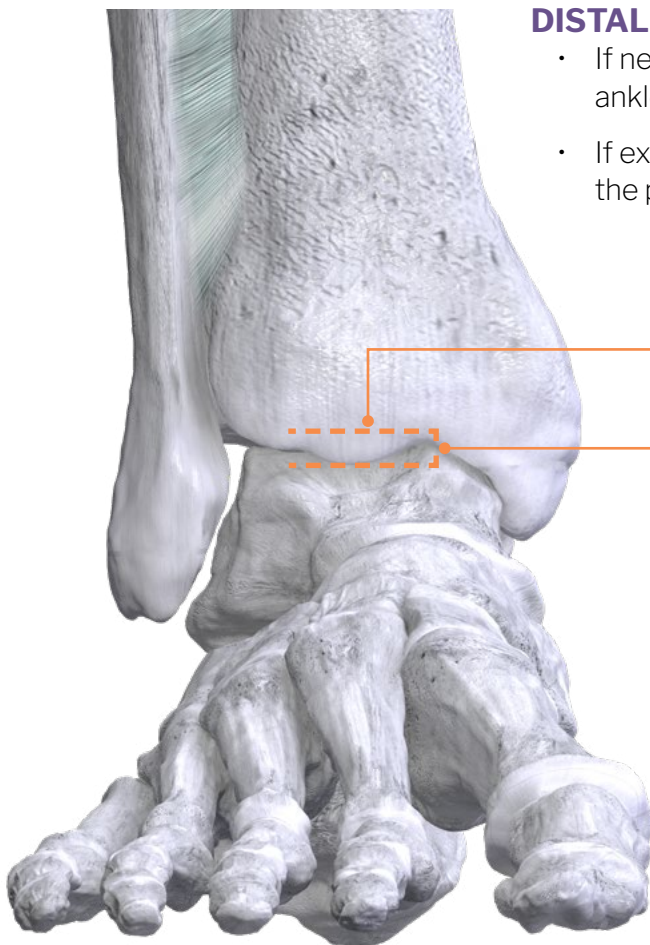

19 mm wide Tibial Bone Resection With Osteotome

2 - 6 mm height Tibial Bone Resection With Osteotome

KEY STEP:

2 MM – 6 MM OF TIBIAL PLAFOND SHOULD BE RESECTED WITH THE PROVIDED 19 MM WIDE STRAIGHT OSTEOTOME [P99-150-0042] TO ALLOW ACCESS TO THE JOINT AND INSTRUMENT POSITION PADDLE.

BACK-TABLE: INSTRUMENT OVERVIEW*

INITIAL POSITIONING

ROTATIONAL & TRANSLATIONAL MICRO ADJUSTMENTS

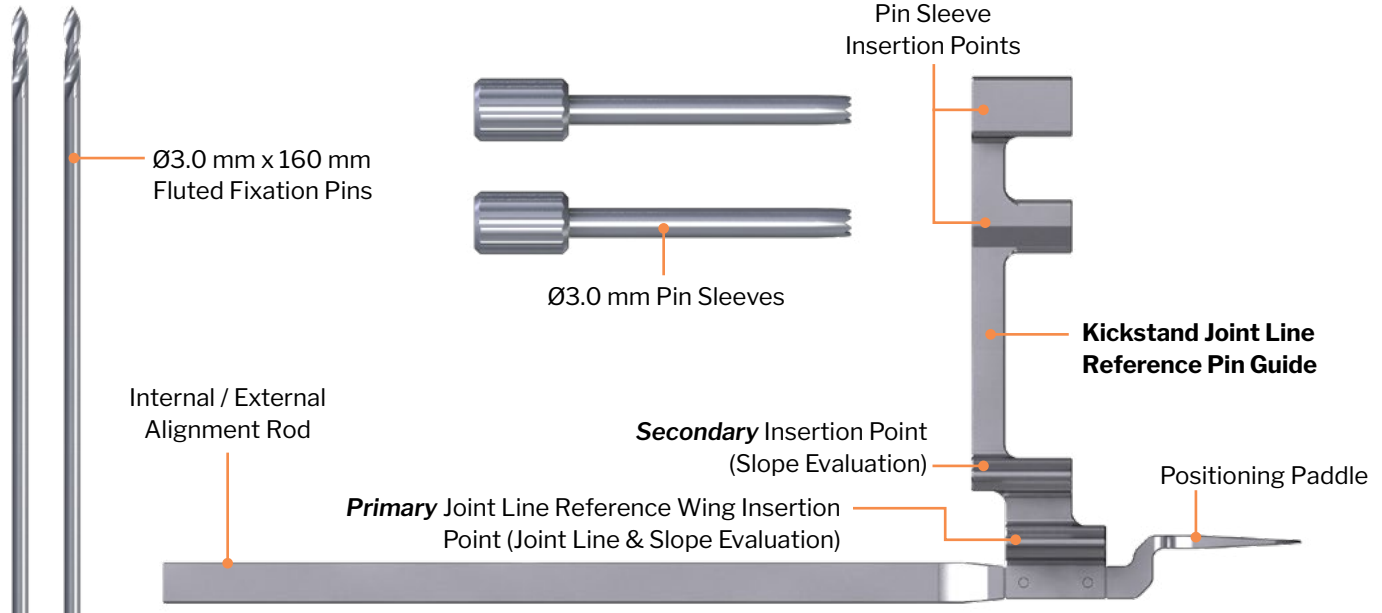

Varus / Valgus FasTrac™ Positioning ShortStack

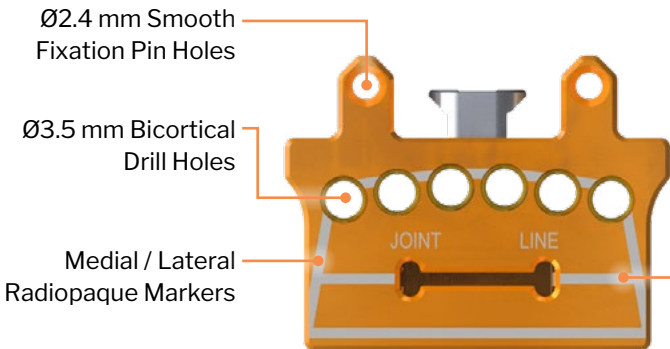
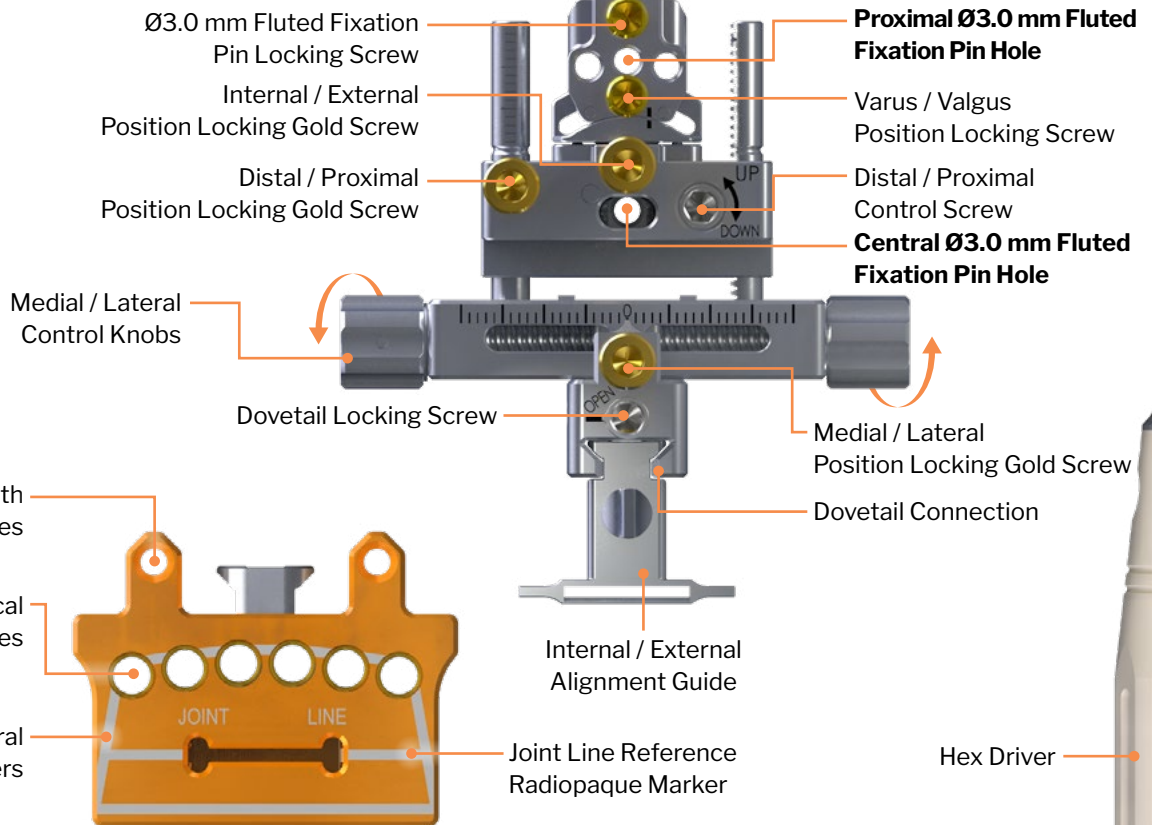

APEX 3D Color Codes

Size 1 - Green	Size 2 - Yellow	Size 3 - Purple	Size 4 - Orange	Size 5 - Dark Blue	Size 6 - Bronze
-----------------------	------------------------	------------------------	------------------------	---------------------------	------------------------

BACK-TABLE: INSTRUMENT OVERVIEW

The Optical Alignment Verification Laser comes sterile packaged, includes a pull tab to prime the device's battery power source, and features a self activating distal switch. When inserted into the appropriate mating instrumentation feature, a button located on the bottom of the device will activate the laser, projecting a beam down towards the operative limb. To safely terminate operation, lift the laser out of the mating device and the laser will turn off.



Internal / External Rotational Alignment

Optical Alignment Verification Laser directed distally

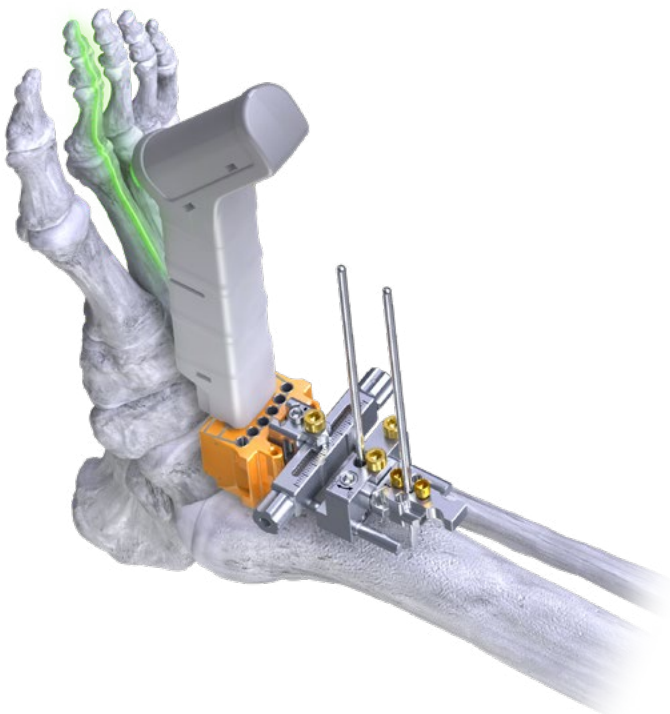

Varus / Valgus Alignment

Optical Alignment Verification Laser directed proximally

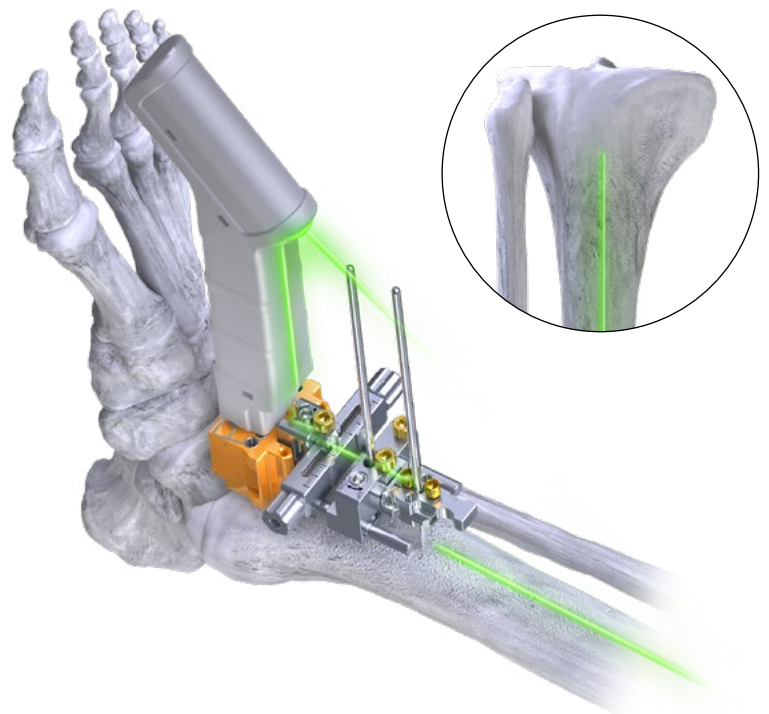

FasTrac™ INITIAL GUIDE POSITIONING

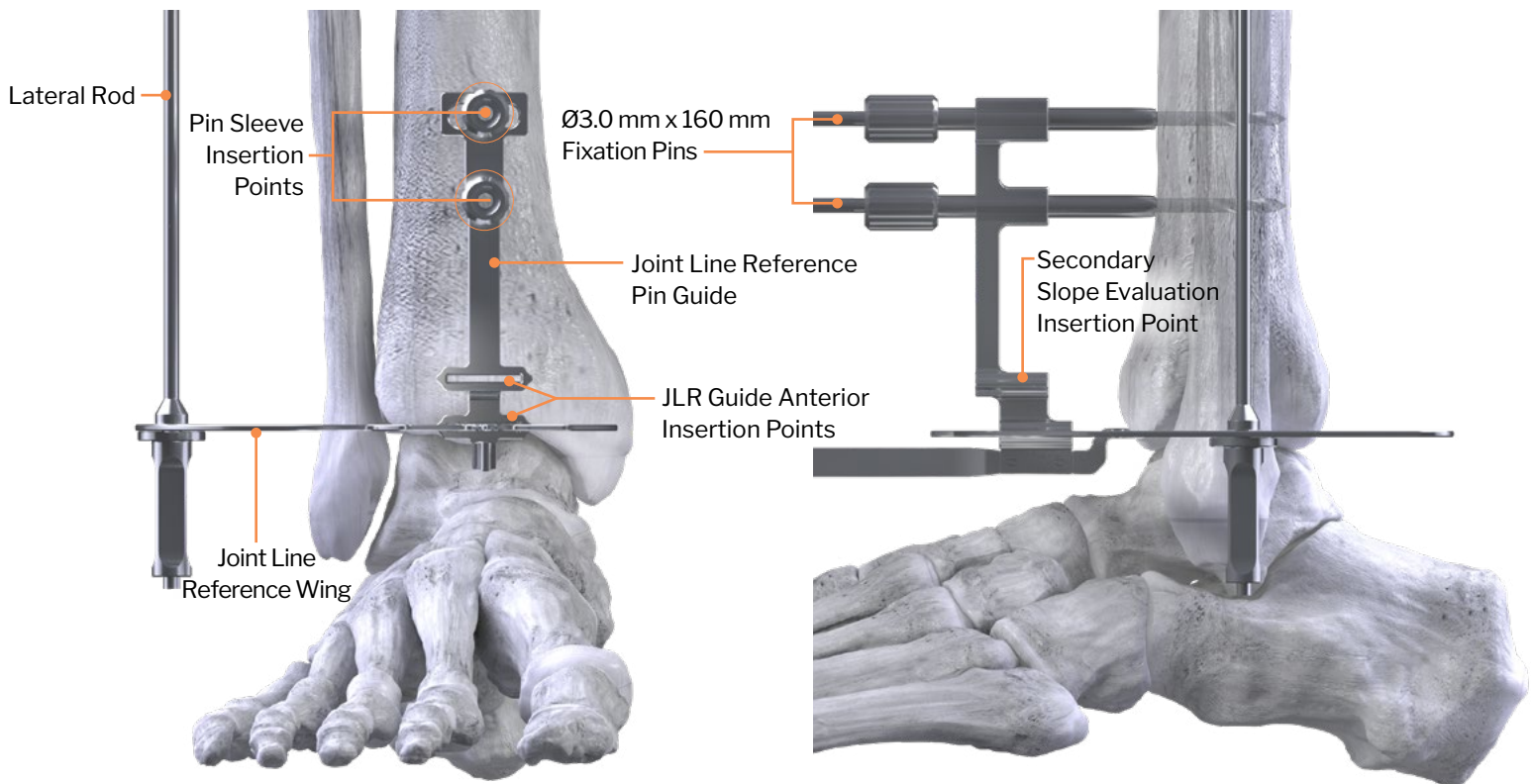

INITIAL GUIDE POSITIONING & GROSS ALIGNMENT

- Utilize the Joint Line Reference (JLR) Pin Guide [P10-940-JL01] to establish initial position by inserting the flat positioning paddle into the prepared tibiotalar joint space.
- Place two (2) Ø3.0 mm Pin Sleeves [P10-940-JL10] into the distal and proximal hole of the JLR Pin Guide, targeting the flat portion of the anterior tibia, taking care to avoid the tibial crest.
- By hand, place one (1) Ø3.0 x 160 mm Fluted Pin [P10-902-3016] into the proximal Pin Sleeve, then place a second in the distal Pin Sleeve.
- Attach the Joint Line Reference Wing [P10-941-AW01] and Lateral Rod [P10-941-AL04] assembly to evaluate distal tibial slope under lateral fluoroscopy.
- Adjust for zero slope with the Lateral Rod by aligning:
 - With tibial canal, or
 - Parallel to the posterior tibial cortex.

ESTABLISH SLOPE

- Connect the proximal Ø3.0 x 160 mm Fluted Pin to power and advance until it clears the posterior cortex, but does not penetrate beyond.
- To fully secure slope, repeat the process for the second distal fixation Pin.
- Remove the JLR Pin Guide and prepare to position the FasTrac™ alignment construct.



SURGICAL NOTE:

Zero distal tibial slope (90° to the tibial axis) is the default alignment with this system. It is recommended that the Wing/Rod assembly be used to evaluate slope. The JLR Pin Guide can also be utilized to assess gross internal/external (I/E) rotation. Additional alignment micro adjustments will be completed in subsequent steps.

FasTrac™ INTERNAL / EXTERNAL ALIGNMENT

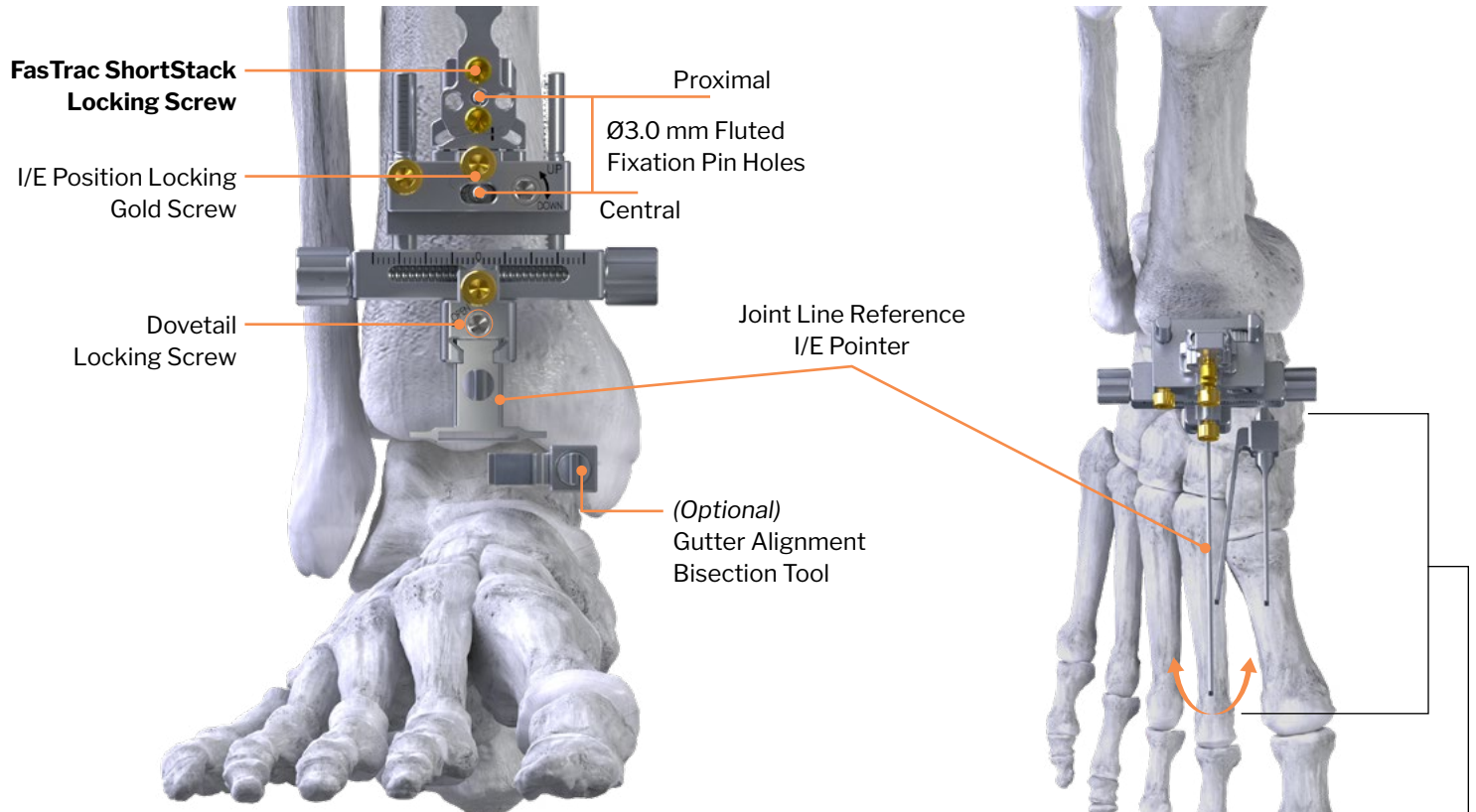

CONSTRUCT PLACEMENT & INTERNAL/EXTERNAL ADJUSTMENTS

- Align the Ø3.0 mm x 160 mm fixation pins with the proximal end of the FasTrac™ construct (selecting from one of the 3-hole options) and central pin hole located on the distal control block.
- Verify the Kickstand Locking Screw, located on the proximal most portion of the FasTrac™ Alignment Jig [P10-941-AL05] is fully tightened against the Ø3.0 mm x 160 mm fixation pin.
- Attach the Joint Line Reference (JLR) I/E Pointer to the receiving dovetail connection of the Distal Control Block and lock with Hex Driver.
- Based on preference, utilize the JLR I/E Pointer to visually guide I/E rotation against:
 - 2nd – 3rd metatarsal, or
 - Medial Gutter by inserting an osteotome in the medial gutter to gauge position, or
 - (Optional) Gutter Alignment Bisection Tool [P10-941-AL06]. This device allows for both medial gutter alignment or gutter bisection based on preference or intraoperative requirements.
- Once final alignment has been established, lock in final position with corresponding gold screw.
- Unlock silver dovetail screw, then remove the I/E Pointer and Gutter Alignment Tool.



SURGICAL NOTE:

The Gutter Alignment Tool is designed to accommodate surgeon I/E rotation preference between 6-8°. The long axis of the tool indicates medial gutter orientation, while the angled projection indicating 8° of external rotation from the medial gutter, approximating gutter bisection.

FasTrac™ INTERNAL / EXTERNAL ALIGNMENT - OPTICAL ALIGNMENT VERIFICATION

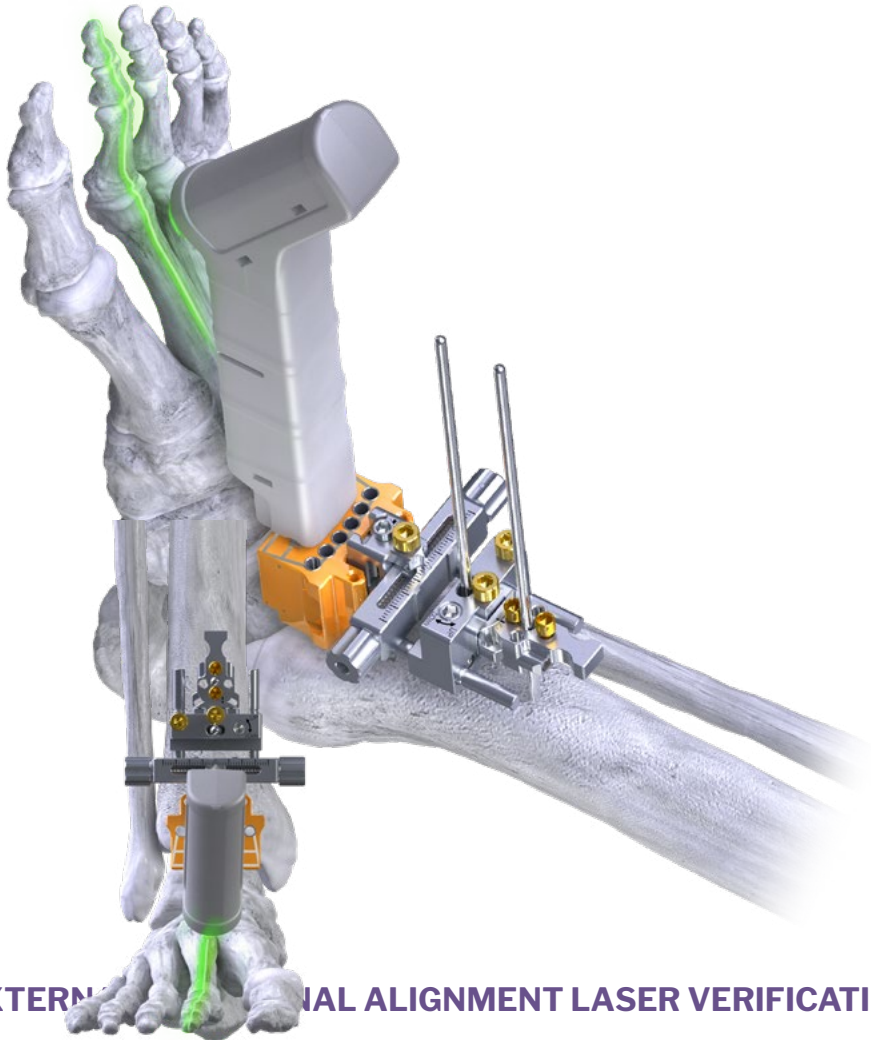

INTERNAL / EXTERNAL ALIGNMENT LASER VERIFICATION

- Insert the Sizing Resection Block [P10-942-SZxx], based on preoperative planning sizing requirements, into the FasTrac™ alignment construct's dovetail connection.
- Utilize the Optical Alignment Laser [P10-941-LAZM] to evaluate and verify I/E rotational alignment by inserting the Laser's shim into the anterior window of the Sizing Resection Block, such that the Laser is facing the distal portion of the operative limb targeting the desired anatomic landmark.



SURGICAL NOTE:

The laser beam will project against the second or third metatarsal respectively, either based on surgical preference or anatomic consideration.

- Complete any additional micro adjustments as necessary
- Once final alignment has been confirmed, remove the Laser.

FasTrac™ MICRO ADJUSTMENTS – VARUS/VALGUS OPTICAL ALIGNMENT VERIFICATION

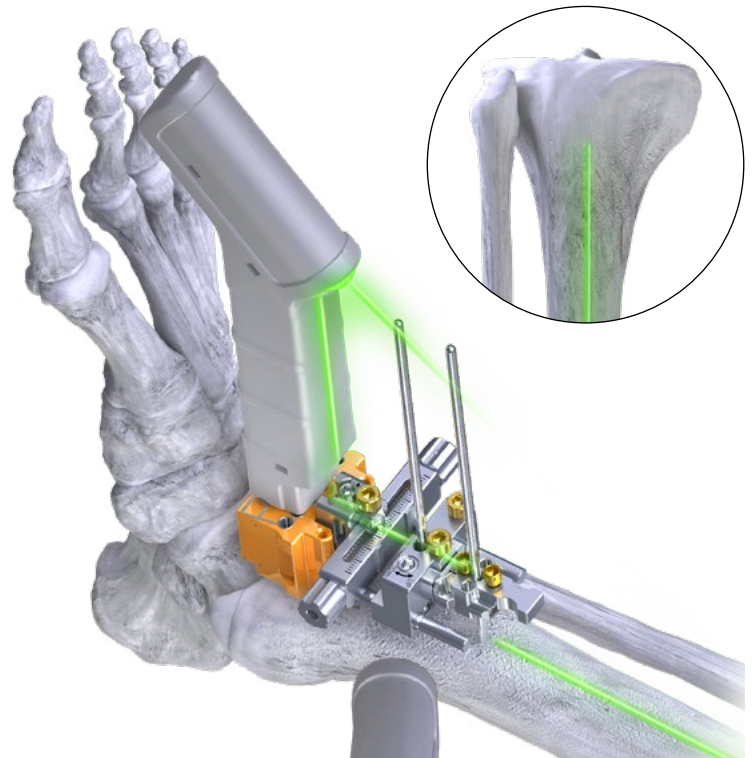
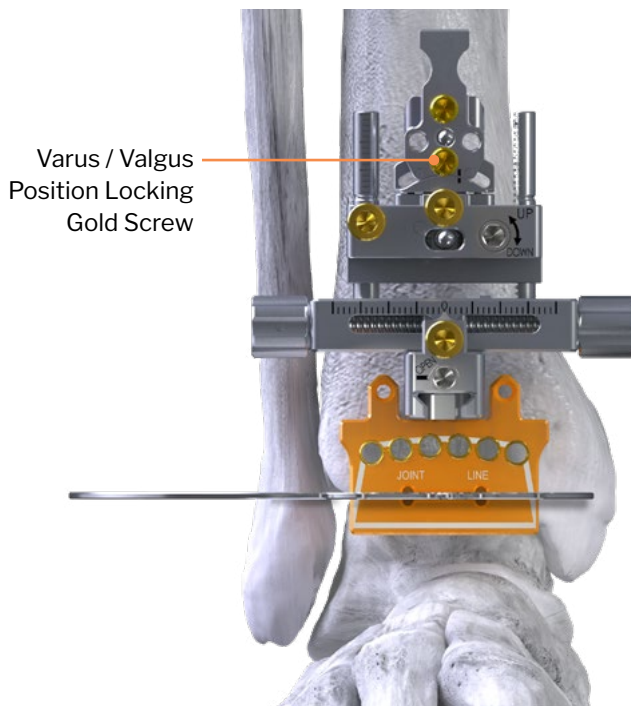

VARUS / VALGUS LASER VERIFICATION

- Under an AP fluoroscopic view, utilize the Sizing Resection Block and Joint Line Resection Wing construct to evaluate varus/valgus position against intraoperative anatomic landmarks.
- The Optical Alignment Verification Laser can also be utilized to confirm varus/valgus position.
- Insert the Laser's shim into the joint line slot of the Sizing Resection Block, such that the Laser is facing towards the proximal portion of the operative limb targeting the tibial tubercle. The Laser features a self-activating switch, when fully inserted the laser beam will activate.
- Once confirmed, secure position by locking the associated gold screw.



SURGICAL NOTE:

The mechanical axis can be used to evaluate appropriate position. For a true AP view, ensure the Wing is overlapping the joint line fluoroscopy marker of the Sizing Resection Block.

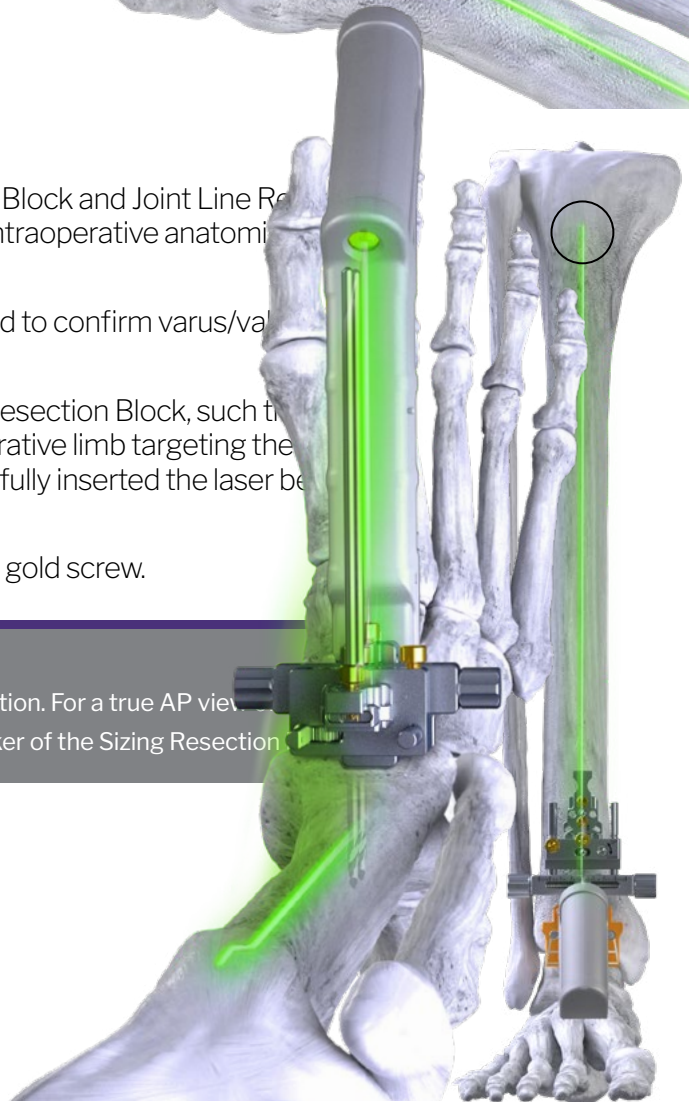

FasTrac™ MICRO ADJUSTMENTS – JOINT LINE HEIGHT, MEDIAL/LATERAL & SIZING

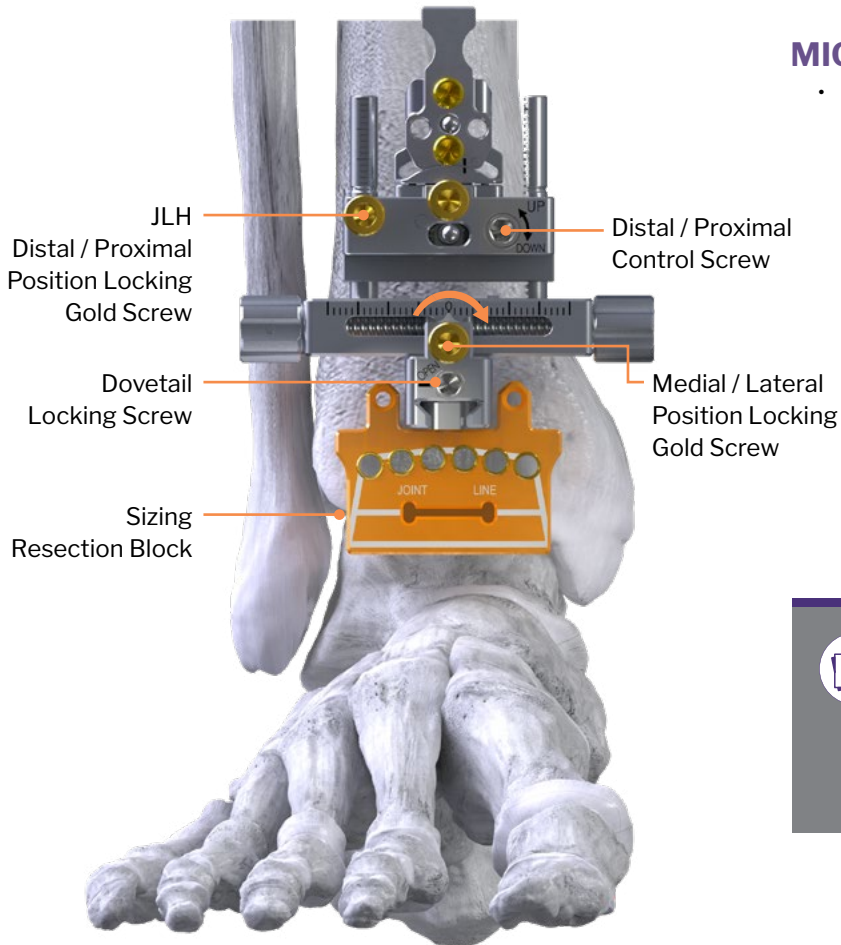

MICRO ADJUSTMENTS

- Under an AP fluoroscopic view, evaluate and adjust:
 - Joint line height against interoperative anatomic landmarks, then secure position by locking the associated gold screw.
 - Medial/Lateral alignment, then secure position by locking the associated gold screw.
 - Sizing, then swap blocks to adjust as necessary, then lock the associated silver dovetail screw.



SURGICAL NOTE:

Radiopaque alignment markers within the Sizing Resection Block are used to evaluate appropriate size, joint line positioning and medial / lateral position within tibiotalar joint.

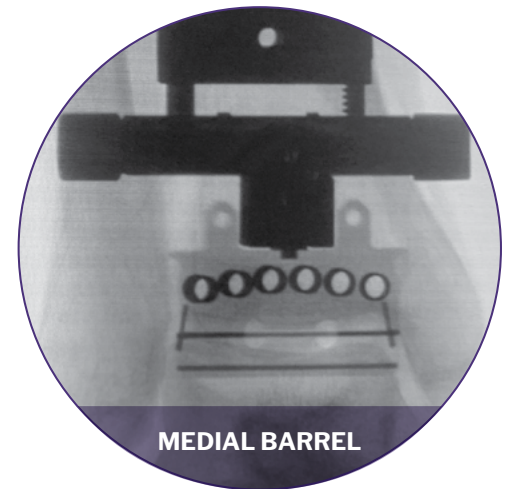
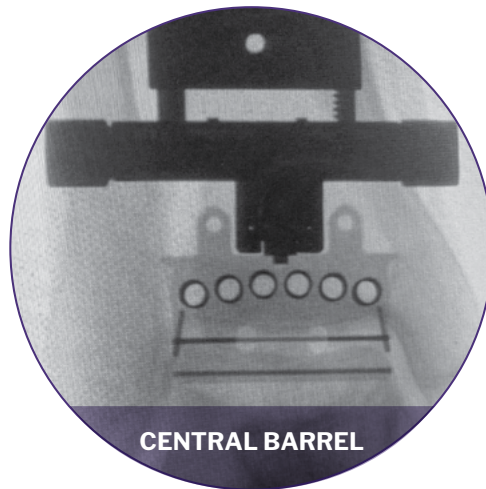
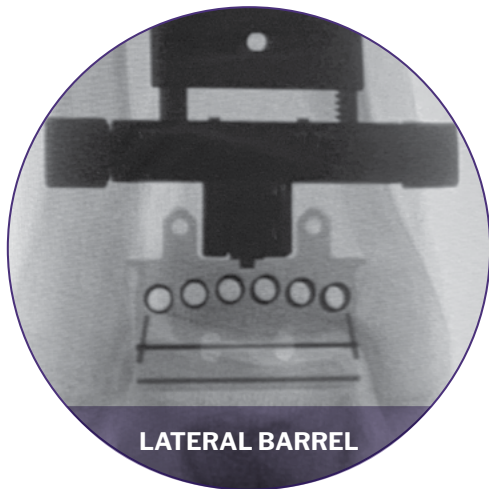

BACK-TABLE PAGE BREAK: INSTRUMENT OVERVIEW*

APEX 3D Color Codes					
Size 1 - Green	Size 2 - Yellow	Size 3 - Purple	Size 4 - Orange	Size 5 - Dark Blue	Size 6 - Bronze
●	●	●	●	●	●

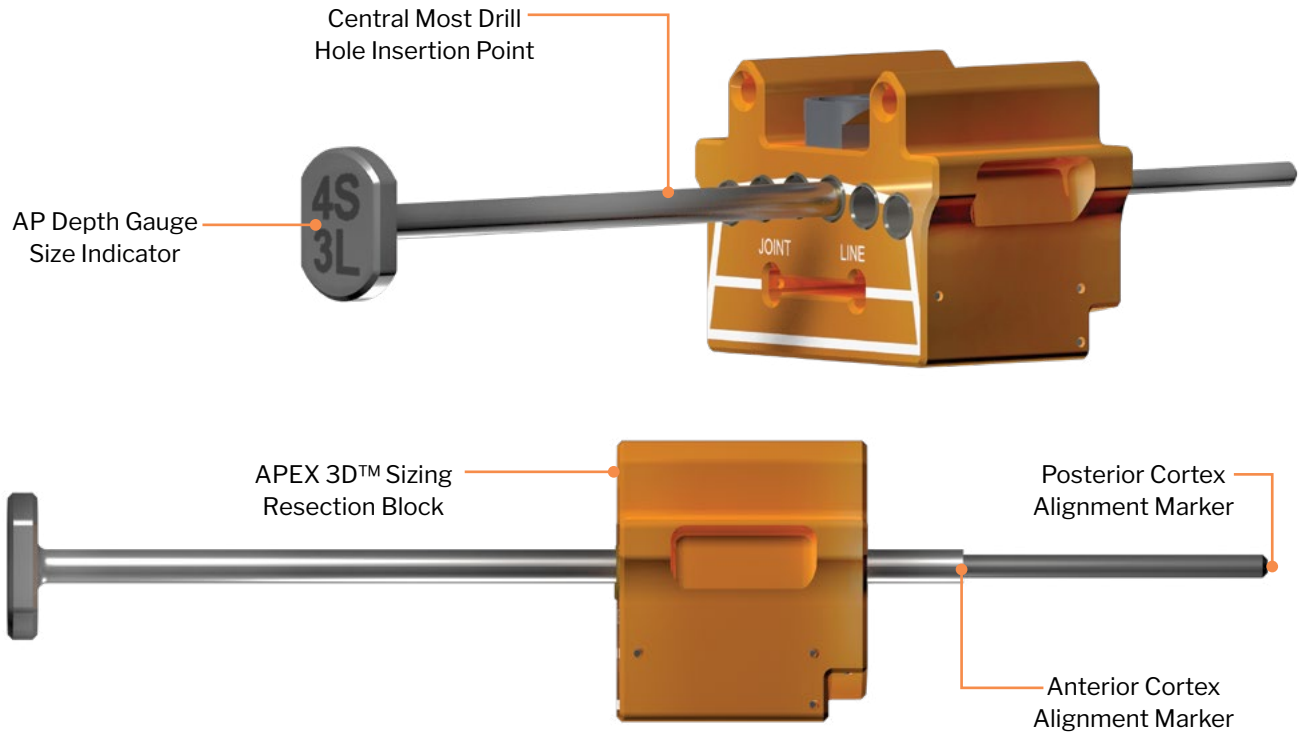

TIBIAL AP DEPTH GAUGES

Size - 1 Standard	1S	
Size - 2 Standard 1 Long	2S 1L	
Size - 3 Standard 2 Long	3S 2L	
Size - 4 Standard 3 Long	4S 3L	
Size - 5 Standard 4 Long	5S 4L	

TIBIAL AP SIZING CONFIRMATION

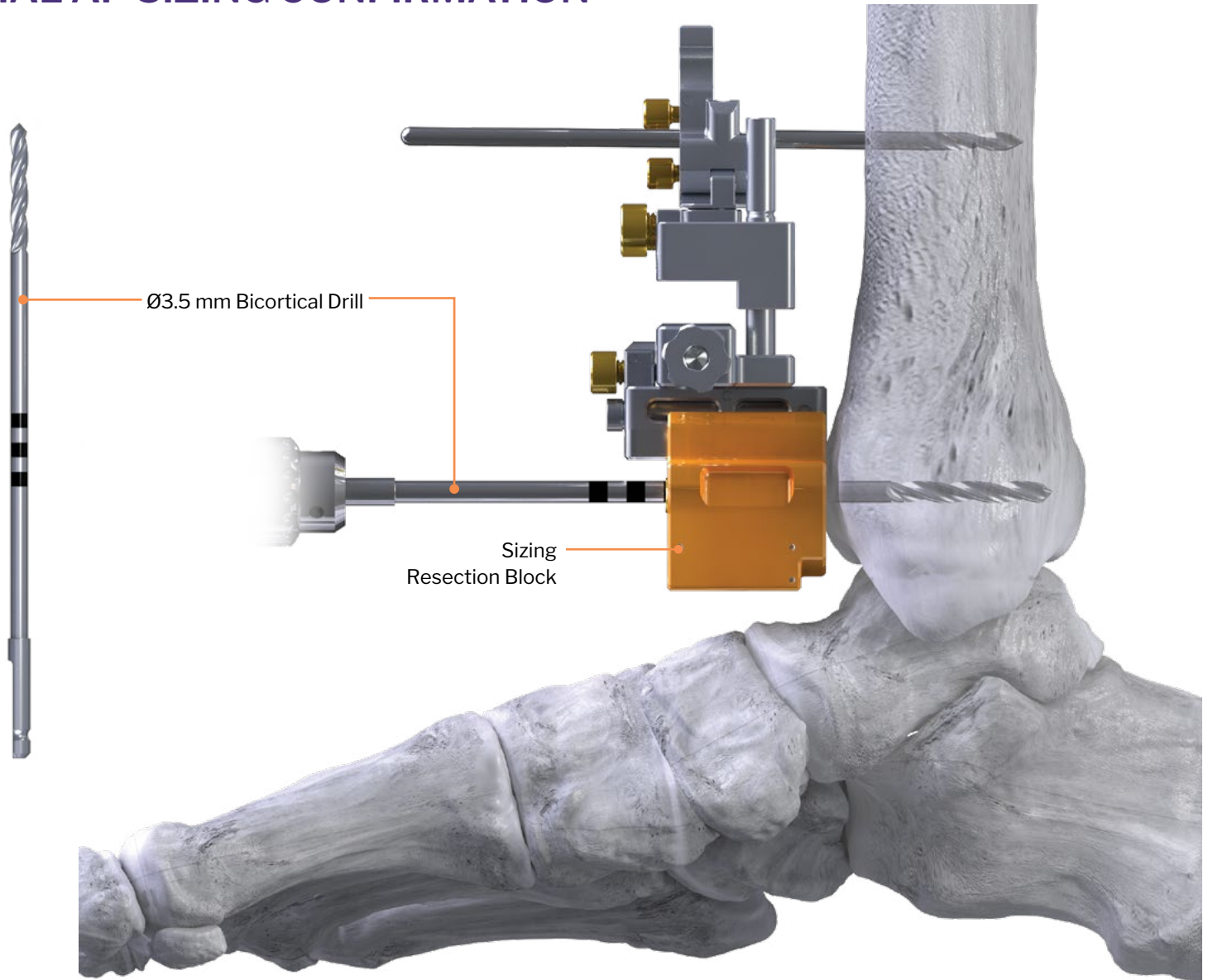

PILOT HOLE – Ø3.5 mm BICORTICAL RESECTION DRILL

- Create a pilot hole utilizing the Ø3.5 mm ARC Tibia Resection Drill [P10-942-3513] to insert the Tibial AP Sizing Depth Gauge [P10-942-APDx].
- Drill bicortically into the central most hole of the Sizing Resection Block, ensuring the Drill clears the posterior cortex, but does not penetrate beyond.
- Remove the Drill and prepare to insert the AP Sizing Depth Gauge.



Surgical note: The medial or lateral drill holes should be avoided and not utilized during the initial AP sizing assessment. If a Flat-Cut tibia was the selected bone resection option, the Sizing Resection Block should still be utilized to assess AP depth and sizing prior to use of the Flat-Cut Resection Block.



Surgical note: ARC Tibia Resection Drill laser markings should be noted and are for reference only. The markings will help to estimate at which point subsequent drilling will perforate the posterior cortex relative the critical drill depth.

TIBIAL AP SIZING CONFIRMATION

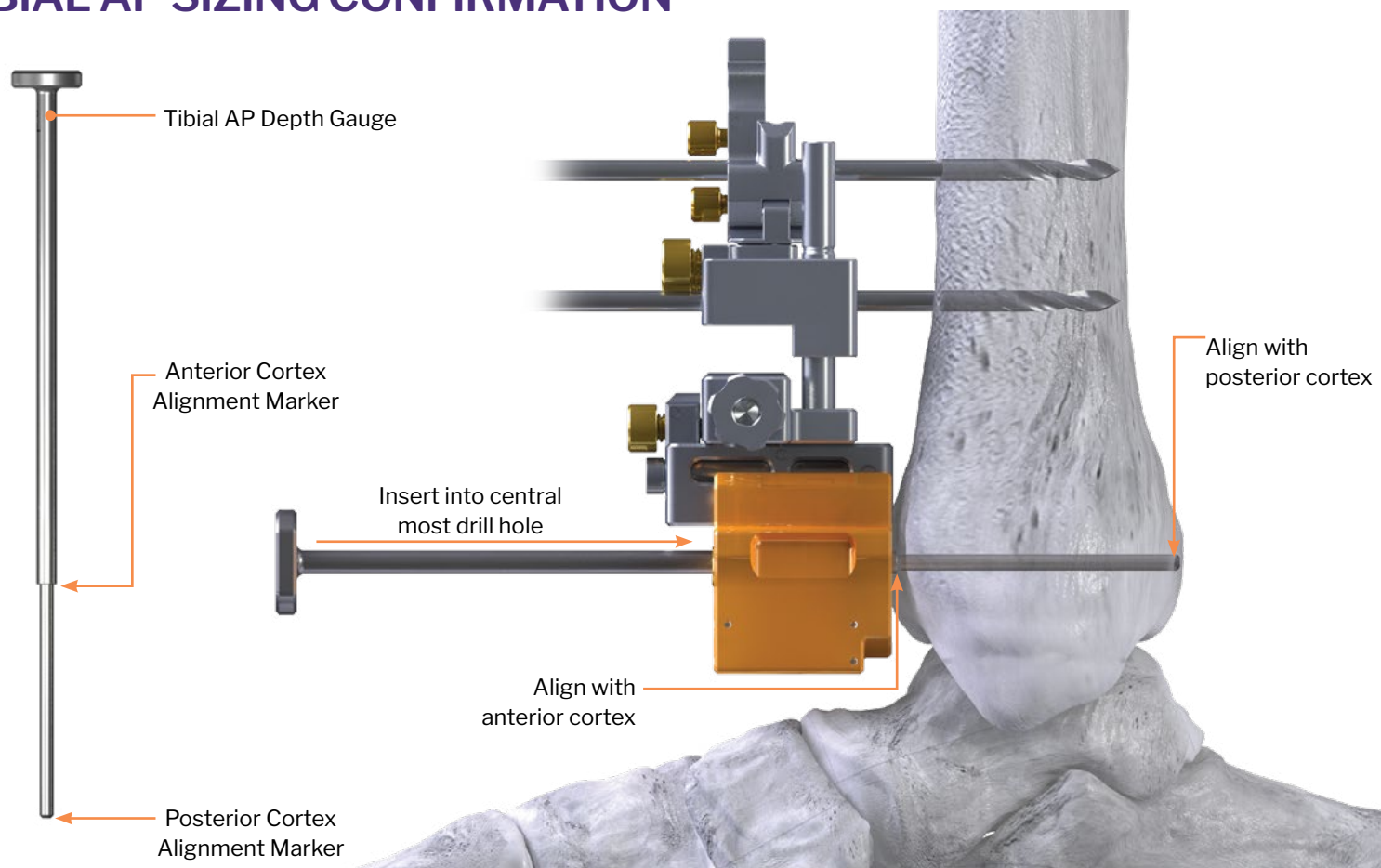

TIBIAL AP SIZING CONFIRMATION

- Insert the appropriately sized Tibial AP Depth Gauge into the previously drilled hole of the Sizing Resection Block.
- Based on the previously selected Sizing Resection Block, utilize the corresponding AP Depth Gauge to evaluate and confirm AP sizing by:
 - Aligning the anterior cortex marker with the anterior cortex of the tibia.
 - Then evaluating the position of the posterior cortex marker against the posterior cortex of the tibia.
 - If necessary, swap Depth Gauges to assess fit; appropriate sizing has been achieved when both the anterior and posterior aspects of the Depth Gauge sit flush with each respective cortices.

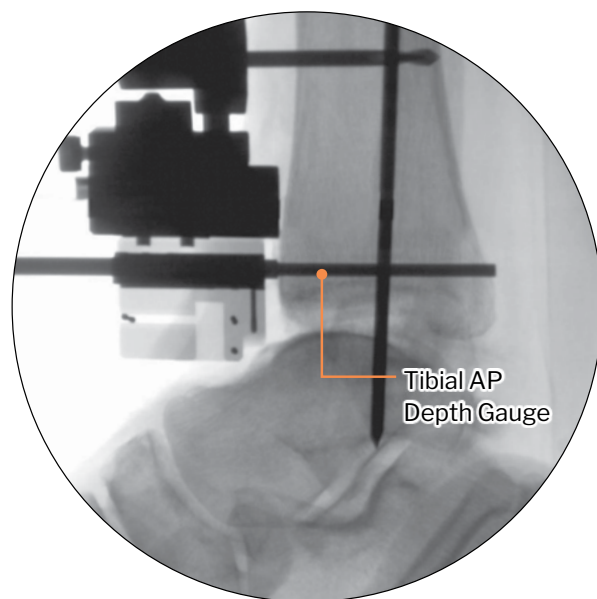

FasTrac™ – FINALIZE & LOCK POSITION

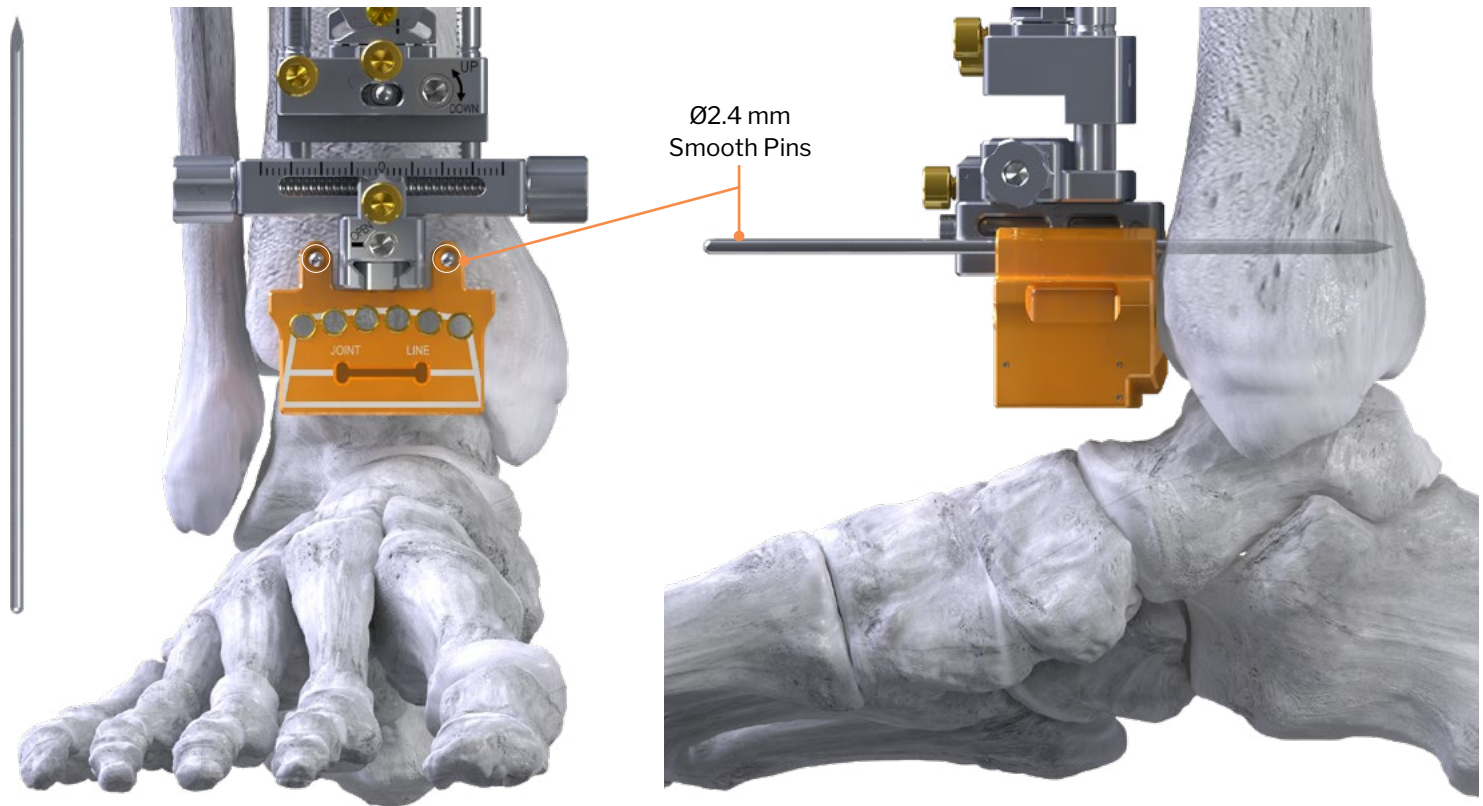

FINALIZE & LOCK IN POSITION

- Once all planes of alignment have been verified and confirmed visually, and under fluoroscopy, finalize position against the tibia by placing (2) Ø2.4 x 110 mm Smooth Steinmann Pins into the most proximal M/L holes of the Sizing Resection Block.



SURGICAL NOTE:

If alignment is not satisfactory based on intraoperative anatomic considerations, the FasTrac™ alignment construct will allow for repeated refinement, positioning and micro adjustments.

BONE PREPARATION, TRIALING, & IMPLANTATION

- Subsequent steps for resection, bone preparation, trialing and implantation of the APEX 3D™ Total Ankle Replacement can be found starting on page 15 of the APEX 3D™ Surgical Technique Guide (P10-STG-0001)

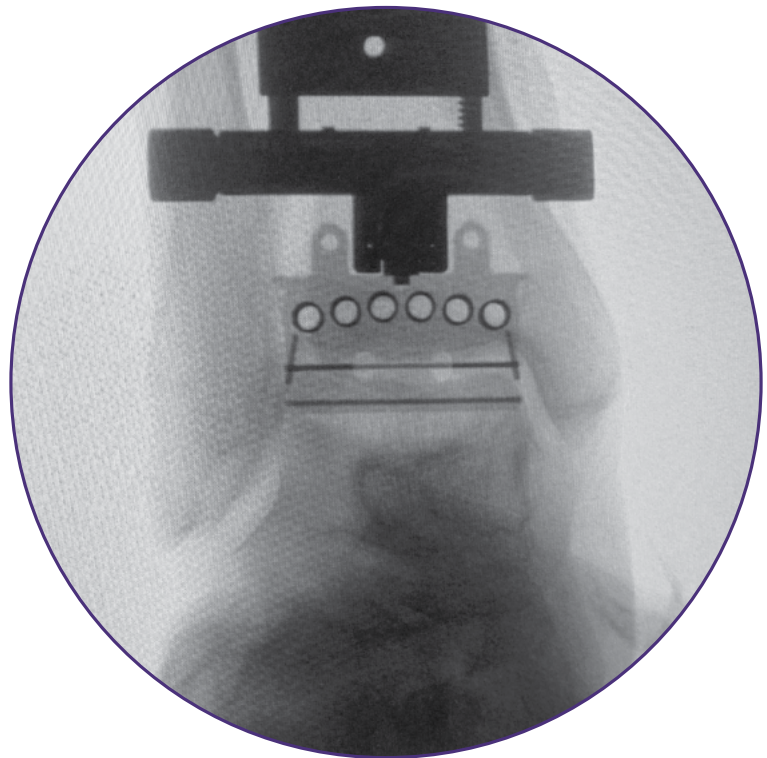

Refer to www.paragon28.com/ifus for the complete and most current instructions for use document.

INDICATIONS FOR USE

The APEX 3D™ Total Ankle Replacement System is indicated as a total ankle replacement in primary surgery for patients with ankle joints damaged by severe rheumatoid, post-traumatic, or degenerative arthritis. Revision surgery for these patients is also indicated for patients with sufficient bone stock present. In the United States, components are intended for cemented use only.

CONTRAINDICATIONS

Use of the APEX 3D™ Total Ankle Replacement System is contraindicated in cases of inflammation, cases of active or suspected sepsis/infection and osteomyelitis; or in patients with certain metabolic diseases.

All applications that are not defined by the indications are contraindicated. In addition, surgical success can be adversely affected by:

- Acute or chronic infections, local or systemic
- Any mental or neuromuscular disorder that could result in an unacceptable risk of failure at the time of fixation or complications in post-operative treatment (e.g. dementia, senility, alcoholism)
- Corpulence; an overweight or corpulent patient can strain the prosthesis to such a degree that stabilization or prosthesis failure can occur
- Excessive loads as caused by activity or patient weight
- Female of childbearing age, for whom a negative pregnancy test is not obtained
- Steroid use
- Inadequate neuromuscular status (e.g. prior paralysis, neuropathy, neuropathic joint, fusion and/or inadequate abductor strength)
- Muscular atrophy
- Osteomyelitis
- Poor bone stock, poor skin coverage, or excessive bone loss around the joint which would make the procedure unjustifiable
- Sepsis
- Skeletally immature patients (patient is less than 21 years of age at the time of surgery)
- Suspected or documented metal allergy or intolerance
- Musculoskeletal disease that may adversely affect gait or weight-bearing
- Neurologic disorder/instability and non-compliance that may adversely affect gait or weight bearing
- Vascular deficiency in the ankle joint

Other medical or surgical pre-conditions that could compromise the potentially beneficial procedure, such as:

- Congenital abnormalities
- Immunosuppressive pathologies
- Increased sedimentation rates that cannot be explained by other pathologies
- Marked bone loss, severe osteoporosis, or revision procedures for which an adequate fit of the prosthesis cannot be achieved
- Metabolic disorders that may impair bone formation
- Osteomalacia
- Poor prognosis for good wound healing

- Presence of tumors
- Increased leukocyte (WBC) count
- Pronounced left shift in the differential leukocyte count
- Uncooperative patient or patient with neurological disorders, incapable of following instructions

POTENTIAL COMPLICATIONS AND ADVERSE REACTIONS

In any surgical procedure, the potential for complications and adverse reactions exist. The risks and complications with these prosthetic components include:

- Asymptomatic, progressive bone resorption (osteolysis) due to foreign body reaction to particulate matter (See **Important Physician Information** section for more information)
- Sensitivity, allergy or other reactions to prosthetic component materials
- Peripheral neuropathies or nerve damage resulting in pain or numbness of the affected limb
- Loosening or migration of the prosthetic components
- Subluxation or dislocation of the prosthetic components with resulting reduction in range of movement
- Bending, disassembly and/or breakage of the prosthetic components
- Fractures resulting from unilateral joint loading
- Fatigue fracture of the prosthetic components as the result of trauma, strenuous activity, improper alignment, incomplete implant seating, or duration of service
- Bone fracture by trauma or excessive loading, particularly in the presence of poor bone stock
- Drop in blood pressure intra-operatively due to the use of bone cement
- Thrombosis, embolism, or myocardial infarction
- Wound hematoma and delayed wound healing
- Acute post-operative wound infections and late infections with possible sepsis
- Pain, a feeling of malaise or abnormal sensations due to the prosthetic components
- Inadequate range of motion due to improper selection or positioning of components or periarticular calcification
- Temporary and protracted functional neurological perturbation
- Corrosion with localized tissue reaction and pain
- Bone loss due to stress shielding

All possible complications listed here are not typical of Paragon 28®, Inc. products but in principle, may be observed with any total joint replacement implant. Promptly inform Paragon 28®, Inc. as soon as complications occur in connection with the implants or surgical instruments used. In the event of premature failure of an implant in which a causal relationship with its geometry, surface quality or mechanical stability is suspected, please provide Paragon 28®, Inc. with the explant(s) in a cleaned, disinfected and sterile condition. Paragon 28®, Inc. cannot accept any other returns of used implants. The surgeon is held liable for complications associated with inadequate asepsis, inadequate preparation of the osseous implant bed in the case of implants, incorrect indication or surgical technique or incorrect patient information and consequent incorrect patient behavior.

Refer to www.paragon28.com/ifus for the complete and most current instructions for use document.

WARNINGS AND PRECAUTIONS

- This device is not intended for subtalar joint fusion or subtalar joint impingement. Please carefully evaluate the anatomy of each patient before implantation.
- The surgeon should discuss with the patient prior to surgery possible risks, precautions, warnings, consequences, complications, and adverse reactions associated with the surgical procedure and implantation of the device.
- Improper selection, placement, positioning, and fixation of the prosthetic components may result in unusual stress conditions and a subsequent reduction in service life of the prosthetic component.
- Periodic, long-term follow-up is recommended to monitor the position and state of the prosthetic components, as well as the condition of the adjoining bone.
- Re-operation to remove or replace prosthetic components may be required at any time due to medical reasons or device failure. If corrective action is not taken, complications may occur.
- Patients need to be informed regarding expectations pertaining to performance and limitations following surgery. The prosthesis does not replace normal bone, has a finite service life, and future revision surgeries may be necessary. Protection of the prosthesis from full weight bearing is needed until adequate fixation and healing is achieved. Certain activities and loading trauma should be limited to prevent unreasonable stresses that could lead to breaking or damage of the prosthetic components.
- Do not attempt a surgical procedure with faulty, damaged or suspect instruments or implants. Inspect all components preoperatively to assure utility.
- Never modify an implant.
- The implants, guide wires, and Laser Alignment Guide are intended for single use only.
- Instruments and implants are to be treated as sharps.
- Do not implant the instruments.
- **LASER RADIATION – DO NOT LOOK INTO THE BEAM!** Do not look directly with optical instruments into the laser beam apertures, since doing so can be hazardous to your eyes!
- The Laser Alignment Guide is not adjustable and maintenance-free.
- Use of the Laser Alignment Guide adjacent to or stacked with other equipment should be avoided because it could result in improper operation. If such use is necessary, this equipment and the other equipment should be observed to verify that they are operating normally.
- Use of accessories, transducers and cables other than those specified or provided by the manufacturer of the Laser Alignment Guide could result in increased electromagnetic emissions or decreased electromagnetic immunity of this equipment and result in improper operation.
- Portable RF communications equipment (including peripherals such as antenna cables and external antennas) should be used no closer than 30 cm (12 inches) to any part of the Laser Alignment Guide, including cables specified by the manufacturer. Otherwise, degradation of the performance of this equipment could result.
- **Do not use other manufacturer's instruments or implants in conjunction with the APEX 3D™ Total Ankle Replacement Device.**
- **Do not re-sterilize the APEX 3D™ Total Ankle Replacement Implants or Instruments.**

Refer to www.paragon28.com/ifus for the complete and most current instructions for use document.

IMPORTANT PHYSICIAN INFORMATION

Bone resorption is a natural consequence of total joint arthroplasty due to changes in bone remodeling patterns. Bone remodeling is mediated by the changes in stress distribution caused by implantation. Extensive resorption around the prosthesis may lead to implant loosening and failure. It is generally agreed that osteolysis is the result of localized foreign-body reaction to particulate debris generated by cement, metal, UHMWPE, and ceramic. Regarding the etiology, it has been hypothesized that particulate debris generated by the components of a prosthesis migrate into the synovial cavity and the bone-implant interface, where they recruit macrophages and stimulate phagocytic action. The degree of recruitment is determined by the size, distribution and amount of particulate debris (rate of debris generation). The phagocytic action results in the release of cytokines and intercellular mediators (IL-1, 2, PE2) which encourage osteoclastic bone resorption. Clinical and basic research is continuing in order to provide scientific basis for the causes of this phenomenon and the potential ways to reduce its occurrence. Osteolysis can be asymptomatic and therefore routine periodic radiographic examination is vital to prevent any serious future complication. Presence of focal lesions that are progressive may necessitate replacement of the prosthetic component(s).

MR SAFETY INFORMATION

The APEX 3D™ Total Ankle Replacement System has not been evaluated for safety and compatibility in the MR environment. It has not been tested for heating, migration, or image artifact in the MR environment. The safety of the APEX 3D™ Total Ankle Replacement System in the MR environment is unknown. MR scanning of a patient who has this device may result in patient injury.

LASER SAFETY INFORMATION

The Laser Alignment Guide uses a diode laser module which emits laser radiation. Do not under any circumstances look directly at the laser beam or any scattered laser radiation – either with the naked eye or with optical instruments.

The Laser Alignment Guide is a Class 3R laser product according to IEC 60825-1:2014. Make sure to comply with all operating safety precautions when using the Laser Alignment Guide.

The maximum output of continuous laser radiation measured at the beam exit is 20mW. The wavelength of the emitted radiation is 532 nm. Beam divergence is measured to be 99° from one end of the line to the other. The Laser contains one Alkaline battery rated 4.5VDC. Environmental conditions of the Laser are those typical of a surgical suite, between 0°C and 60°C and 15% to 90% humidity.

User should refer to IEC 60601-1 Medical electrical equipment – Part 1: General requirements for basic safety and essential performance for requirements applicable to medical electrical systems.

PARAGON 28, INC.
 14445 GRASSLANDS DR.
 ENGLEWOOD CO 80112,
 855-786-2828
MODEL P10-941-LAZM
 Battery Rating: 4.5VDC

 MADE IN USA
 COMPLIES WITH 21 CFR 1040.10
 AND 1040.11 EXCEPT FOR CONFORMANCE WITH
 IEC 60825-1 ED. 3., AS DESCRIBED IN LASER
 NOTICE NO. 56, DATED MAY 8, 2019.

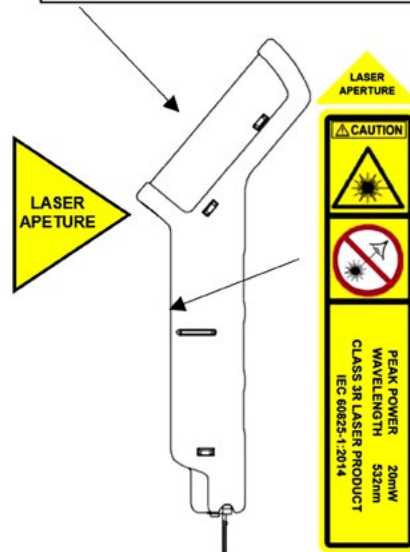

Lined area for notes with horizontal ruling lines.



P10-STG-0003 Rev. D [2023-01-19]

™Trademarks and ®Registered Marks of Paragon 28®, Inc.

© Copyright 2022 Paragon 28®, Inc. All rights reserved.

Patents: www.paragon28.com/patents

Paragon 28, Inc. 
14445 Grasslands Dr.
Englewood, CO 80112
(855) 786-2828

DISCLAIMER

The purpose of the APEX 3D™ Total Ankle Replacement System Surgical Technique Guide is to demonstrate the use of the APEX 3D™ Total Ankle Replacement System. Although various methods can be employed for this procedure, the fixation options demonstrated were chosen for simplicity of explanation and demonstration of the unique features of our device. Federal law (U.S.A.) restricts this device to sale and use by, or on order of, a physician.

PATENTED, DESIGNED & EXCLUSIVELY
DISTRIBUTED BY

Exclusively foot & ankle **28**
Paragon®

www.Paragon28.com